

PUE HY10

WEIGHING INDICATOR

USER MANUAL

ITKU-89-03-11-20-EN













 **RADWAG BALANCES AND SCALES**
ADVANCED WEIGHING TECHNOLOGIES

NOVEMBER 2020

PRECAUTIONS

Prior to installation, use or maintenance activities, carefully read this user manual. Use the PUE HY10 Indicator only as intended.

	Prior to the first use, carefully read this user manual. Use the device only as intended.
	Protect the indicator against considerable temperature variation, solar and UV radiation, substances causing chemical reactions.
	Do not operate the touch panel using sharp-edged tools (knife, screwdriver, etc.).
	The indicator must not be operated in hazardous areas endangered with explosion of gases, and in dusty environments.
	If the platform is to be operated in a place characterized with conditions that are difficult due to electrostatics (e.g. printing house, packing centre, etc.), you must connect it to the earth wire. To enable this, the device features functional earthing terminal, marked with \perp symbol.
	In case of damage, immediately unplug the device from the mains.
	Indicators to be decommissioned must be decommissioned in accordance with valid legal regulations.
	Do not let battery discharge in case of prolonged storage of the device in low temperature.
	A worn out battery can be replaced only by the manufacturer or by the authorized service.
	Accumulators do not belong to regular household waste. The European legislation requires discharged accumulators to be collected and disposed separately from other communal waste with the aim of being recycled. Symbols on batteries identify harmful compounds: Pb = lead, Cd = cadmium, Hg = mercury. Dear user, you are obliged to dispose of the worn out battery as regulated.
	Wi-Fi ® is a registered trademark of Wi-Fi Alliance. The trademark used in this document serves informative purposes, it does not stand for compliance of any products with products certified by Wi-Fi® Alliance organisation.

Contents

1. INTENDED USE	5
2. WARRANTY CONDITIONS	5
3. MAINTENANCE	6
3.1. Cleaning Stainless Steel Components	6
3.2. Cleaning ABS Components.....	6
4. MECHANICAL DESIGN	6
4.1. Dimensions.....	6
4.2. Connectors	7
4.3. Pins Assignment.....	8
4.4. Inputs / Outputs	8
4.4.1. Technical Specifications.....	9
4.4.2. I/O Schematic Diagrams	9
4.5. Operation Panel.....	10
4.6. Technical Specifications.....	11
5. INDICATOR INSTALLATION	12
5.1. Unpacking and Installation	12
5.2. Start-Up	12
6. HOME SCREEN	12
6.1. Top Bar.....	13
6.2. Workspace.....	13
7. OPERATING THE MENU	14
7.1. Operation Panel.....	14
7.2. Return to Weighing.....	15
8. INSTALLER INSTRUCTION	15
8.1. Connecting Platform Equipped With 6-Wire Load Cells	15
8.2. Connecting Platform Equipped With 4-Wire Load Cells	16
8.3. Connecting Signal Cable's Shield With the Platform	17
8.3.1. Checking Connection of Load Cell's Shield	17
9. FACTORY SETUP	17
9.1. Factory Setup Access	18
9.2. Global Parameters.....	18
9.3. Factory Parameters.....	20
9.4. Metrological Data.....	21
9.5. Factory Adjustment.....	22
9.5.1. External Adjustment	22
9.5.2. Start Mass Determination	22
9.6. Linearity Correction	23
9.6.1. Linearity Determination	23
9.6.2. Corrections	23
9.6.3. Deleting Linearity.....	24
9.7. Gravitational Correction.....	24
9.7.1. Entering the Gravitational Correction Value.....	24
9.7.2. Gravitational Acceleration Method	25
9.7.3. Latitude Method.....	26
9.8. Declaring Verified Scale.....	27
10. OPTIONAL EXTENSION MODULES	27
10.1. Additional 12IN/12OUT	27
10.2. 4IN/4OUT Module	29
10.3. AN Analog Output Module	30
10.4. Additional Platform Module, DP6	32
10.5. RS485 Module (309R).....	33
10.6. PROFIBUS module	33
10.7. PROFINET Module	34
10.8. Additional Modules Positioning	35
10.9. Exclusions Regarding Installation of Additional Modules	36
11. ANNEX A - Communication with Modules Taking Function of an Additional Weighing Platform	36
11.1. Communication with a Weighing Module Supporting 'Scale with NT Command' Protocol'	36
11.2. Communication with MW-01 Weighing Module	38
11.3. Communication with HRP Weighing Module	42
12. DIAGRAMS OF CONNECTION CABLES	47

1. INTENDED USE

PUE HY10 weighing indicator is a device intended to be a part of construction of industrial scales based on load cells and electromagnetic modules. The PUE HY10 is equipped with stainless steel housing of IP 68/69 ingress protection. It can be operated in places where there is high humidity, its operating temperature range is: -10°C - +40°C. Colour 10.1" capacitive screen with touch panel enables intuitive operation, making use of keyboard unnecessary.

Standard PUE HY10 indicator is equipped with 2 RS232, 2 USB, 4In/Out connectors and Ethernet port. It can connect up to 6 weighing platforms (2 x internal weighing module + 4 x external weighing module). It cooperates with barcode scanners, receipt printers, label printers, RFID readers and PC accessories (mouse, keyboard, USB flash drive).

2. WARRANTY CONDITIONS

- A. RADWAG feels obliged to repair or exchange all elements that appear to be faulty by production or by construction.
- B. Defining defects of unclear origin and means of their elimination can only be realized with assistance of the manufacturer and user representatives.
- C. RADWAG does not bear any responsibility for damage or losses resulting from unauthorized or inadequate performing of production or service processes.
- D. The warranty does not cover:
 - mechanical damage caused by product exploitation other than intended, damage of thermal and chemical origin, damage caused by lightning, overvoltage in the power grid or other random event,
 - inappropriate cleaning habits.
- E. Loss of warranty takes place if:
 - a repair is carried out outside RADWAG authorized service point,
 - service claims intrusion into mechanical or electronic construction by unauthorized people,
 - other than original version of the operating system is installed,
 - the scale does not bear security seal stickers.
- F. For detailed warranty conditions read the service card.
- G. Contact with the central authorized service: +48 (48) 386 63 30.

3. MAINTENANCE

3.1. Cleaning Stainless Steel Components

Avoid using cleansers containing any corrosive chemicals, e.g. bleach (with chlorine). Do not use cleansers containing abrasive substances. Always remove the dirt using microfiber cloth to avoid damage of protective coating.

Daily cleaning routine (removal of small stains):

1. Remove the dirt using cloth dipped in warm water.
2. For best results, add a little bit of dishwashing detergent.

3.2. Cleaning ABS Components

To clean dry surfaces and avoid smudging, use clean non-colouring cloths made of cellulose or cotton. You can use a solution of water and detergent (soap, dishwashing detergent, glass cleaner). Gently rub the cleaned surface and let it dry. Repeat the cleaning process if necessary.

In the case of hard to remove contamination, e.g. residues of adhesive, rubber, resin, polyurethane foam etc., you can use a special cleaning agents based on a mixture of aliphatic hydrocarbons that do not dissolve plastics. Before using the cleanser for all surfaces we recommend carrying out tests. Do not use cleansers containing abrasive substances.

4. MECHANICAL DESIGN

4.1. Dimensions

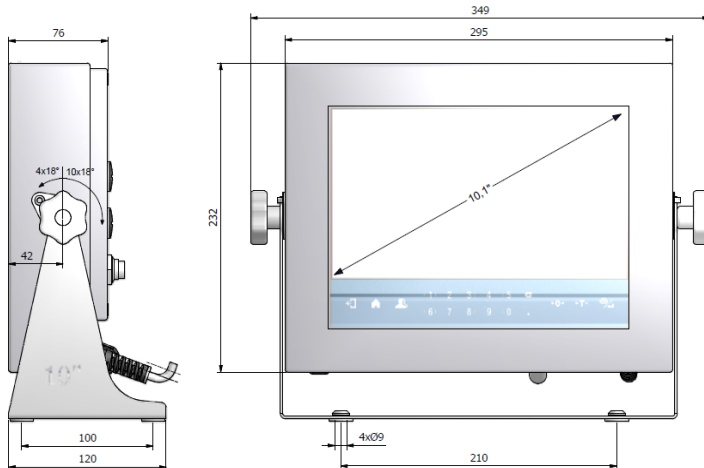

PUE HY10 indicator, overall dimensions

4.2. Connectors

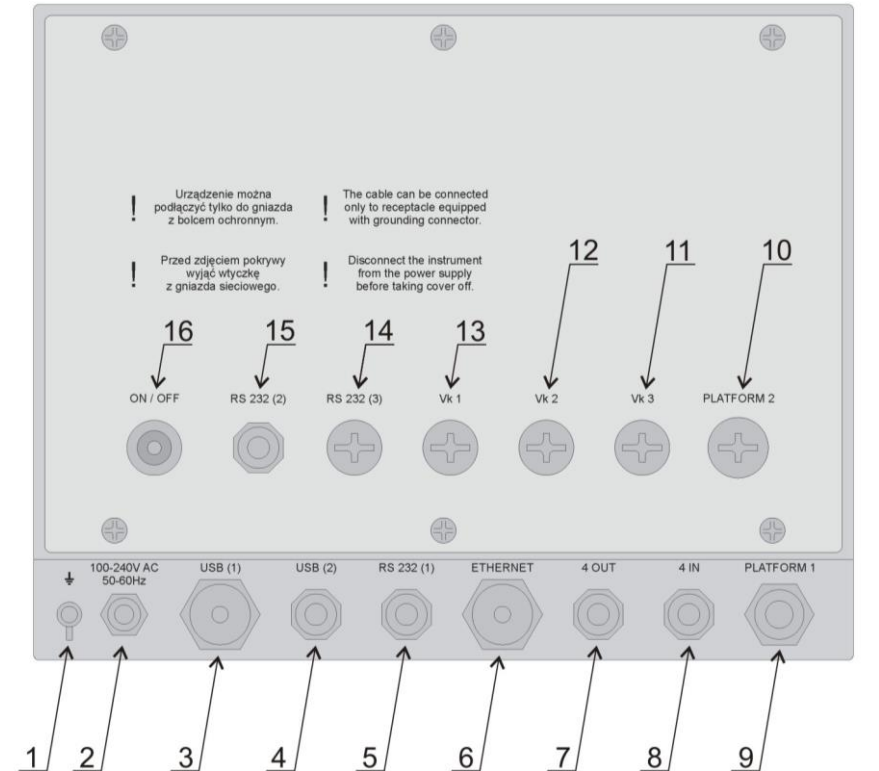

PUE HY10 indicator, connectors

1	Grounding terminal.
2	Power cord cable gland.
3	USB A connector.
4	USB M12 4P connector.
5	RS232(1) M12 8P connector.
6	Ethernet RJ45 connector.
7	4OUT M12 8P connector.
8	4IN M12 8P connector.
9	Platform 1 cable gland.
10	Platform 2 cable gland.
11	Spot intended for cable gland / additional equipment connector (Vk3, 12IN, PROFIBUS IN) – mounted depending on indicator type, by default plugged.
12	Spot intended for cable gland / additional equipment connector (Vk2, 12OUT, PROFIBUS OUT) – mounted depending on indicator type, by default plugged.

13	Spot intended for cable gland / additional equipment connector (Vk1, RS485, Analog OUT) – mounted depending on indicator type, by default plugged.
14	RS232(3) M12 8P connector - optional.
15	RS232 (2) connector.
16	Power supply switch.

4.3. Pins Assignment

RS232		Pin1 – NC Pin2 – Rx/D Pin3 – Tx/D Pin4 – NC Pin5 – GND Pin6 – +5VDC Pin7 – GNDZ Pin8 – 24VDC
USB		Pin1 – Vcc Pin2 – D- Pin3 – D+ Pin4 – GND
PROFIBUS IN (male)		Pin1 – NC Pin2 – A Pin3 – NC Pin4 – B Pin5 – NC
PROFIBUS OUT (female)		Pin1 – +5V Pin2 – A Pin3 – GND Pin4 – B Pin5 – NC

4.4. Inputs / Outputs

Standard HY10 HRP terminal is equipped with 4 optoisolated inputs and 4 semiconductor outputs (solid-state relays)). The signals are fed through M12 8P connectors.

4OUTPUTS		Pin1 – OUT1 Pin2 – OUT2 Pin3 – OUT3 Pin4 – OUT4 Pin5 – COM Pin6 – 24VDC Pin7 – GND Pin8 – NC
----------	--	---

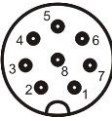
4INPUTS		Pin1 – IN1 Pin2 – IN2 Pin3 – IN3 Pin4 – IN4 Pin5 – COM Pin6 – 24VDC Pin7 – GND Pin8 – NC
---------	---	---

4.4.1. Technical Specifications

Output parameters	
Output quantity	4
Output type	Solid-state relay
Cable cross-section	0.14 - 0.5 mm ²
Maximum output current	0.5 A DC
Maximum output voltage	30 VDC, AC

Input parameters	
Input quantity	4
Input type	Optoisolated
Cable cross-section	0.14 - 0.5 mm ²
Voltage range	5 - 24 VDC

4.4.2. I/O Schematic Diagrams

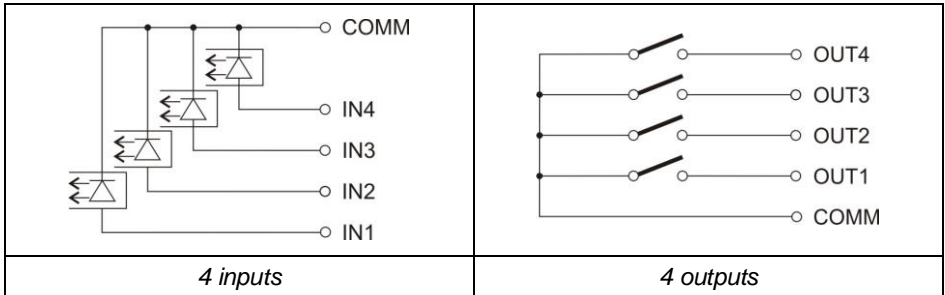



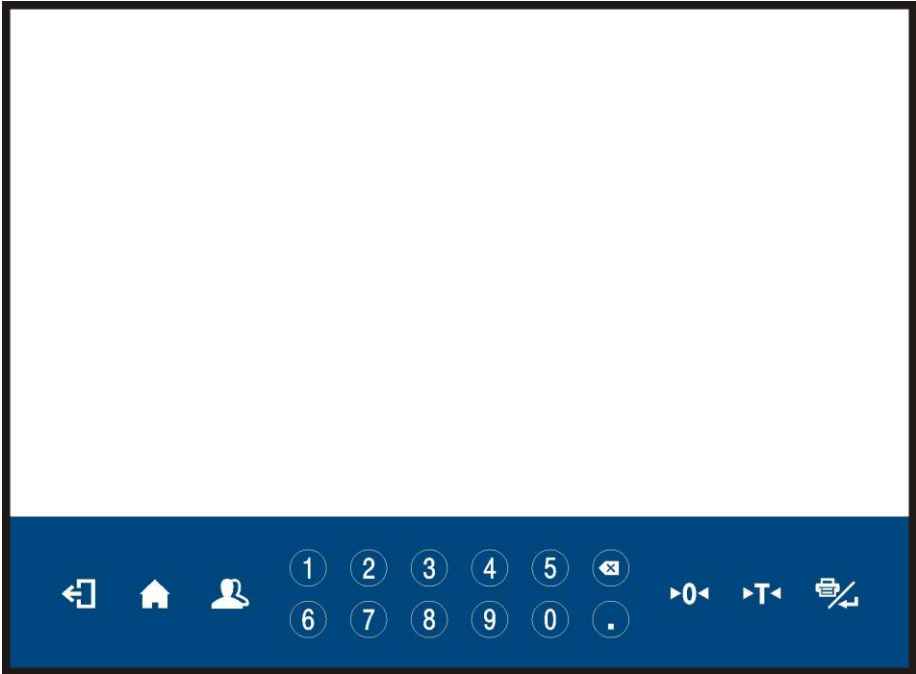





4.5. Operation Panel



PUE HY10 indicator, keypad

Keys

	Press to go back
	Press to enter the menu. Press to go to the home screen.
	Press to log in.
	Press to zero the scale.
	Press to tare the scale.
	Press to send the weighing result to a printer or a computer.
	Press to delete the last character.

	Dot character.
	Numeric keys.

4.6. Technical Specifications

General parameters

Housing	Stainless steel
Ingress protection	IP68 (1h max) / 69
Display	10.1" - colour, widescreen 1024 x 600 + touch panel
Power supply	100 ÷ 240 VAC 50 ÷ 60 Hz
Optional power supply	External, 12 ÷ 24 VDC
Operating temperature	-10 °C + 40 °C
Relative humidity	10 ÷ 85 % RH no condensation

Metrological parameters

OIML class	II or III
Verification units	6000
Standard platform qty	1
Maximum platform qty	6 (2 x internal weighing module + 4 x external weighing module)
Maximum input signal	19.5 mV
Maximum voltage per verification unit	3.25 µV
Minimum voltage per verification unit	0.4 µV
Minimum load cell impedance	50 Ω
Maximum load cell impedance	1200 Ω
Load cell power supply	5 V DC
Load cell wiring	4 or 6 wires + Shield

Communication

Standard RS232 interface	2 x hermetic connector
Standard USB interface	1 x hermetic M12 connector, 1 x hermetic USB A connector
Standard Ethernet interface	10/100 Mb, 1 x hermetic RJ45 connector
Standard IN/OUT interface	4 x IN - connector, 4 x OUT - connector
MODBUS communication interface	YES

Extra options

12IN module	12IN/12OUT – cable gland
AN module	Analog outputs modes: 4 - 20 mA, 0 - 20 mA, 0 - 10 V (cable gland)
PROFIBUS module	1 × M12 5P connector, B-coded, DP SLAVE
PROFINET module	1 x hermetic RJ45 connector
RS232 interface	1 x hermetic M12 8P connector
RS485 interface	1 x cable gland
Additional platform module DP6	1 x cable gland
Wi-Fi® module	2.4 GHz
Multi-range option	YES

5. INDICATOR INSTALLATION

5.1. Unpacking and Installation

- Take the indicator out of the packaging.
- Connect the indicator to a weighing platform, next place the weighing device on a flat and even surface. Keep it away from any sources of heat.
- To level the weighing instrument turn its feet. Keep turning the feet until the air bubble takes central position:

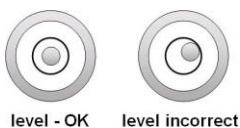

5.2. Start-Up

- Turn the power on, do it by pressing **ON/OFF** switch located at the back of the indicator housing. Operating system loading begins.
- Upon completed start-up, the home screen is displayed automatically.
- The device is ready for operation.

6. HOME SCREEN

The home screen can be divided into 2 sections: a top bar, a workspace.

Home screen layout:

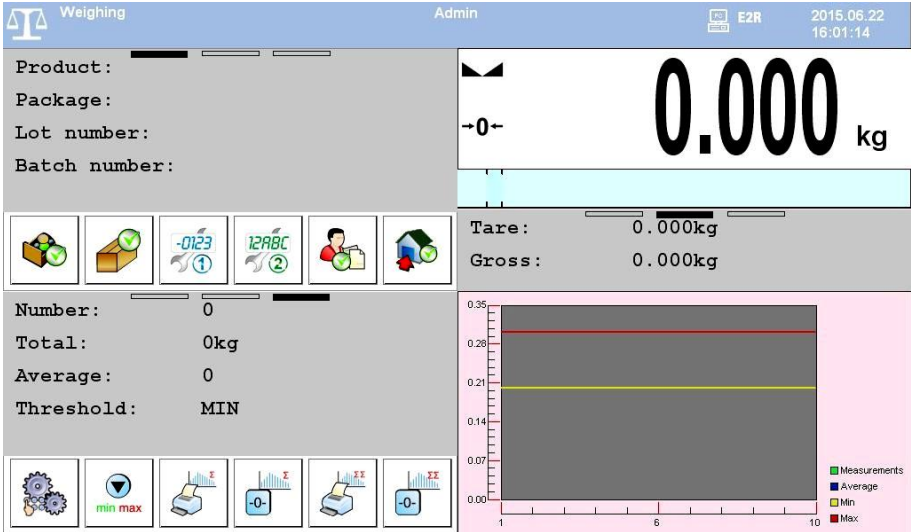

Detailed instruction on how to configure the home screen is to be found in „PUE HY10 Indicator Software Manual”.

6.1. Top Bar

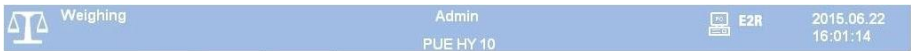

The top bar displays the following information:

Weighing	Working mode name and symbol.
Log In	Login entry.
	Symbol informing that communication with a PC is on.
E2R	Symbol informing that communication with the E2R SYSTEM is on.
PUE HY 10	Weighing device name.
2012.06.06 06:06:06	Date and time.

















6.2. Workspace





The workspace is placed under the top bar, it features 4 screens, programmable for each working mode. You can customize the workspace freely.

7. OPERATING THE MENU

Due to a colour display and a touch panel, operation of the HY10 indicator menu is intuitive and simple.



7.1. Operation Panel

	Press to go to the menu. Press to go to the home screen directly.
	Press to go to the home screen directly.
	Press to go back.
	Press to go back.
	Press to scroll the menu up.
	Press to scroll the menu down.
	Press to scroll the menu up-down fast.
	Press to confirm modifications.
	Press to exit, the parameter remains unmodified.
	Press to add a database record.
	Press to disable the selected record. Press to log out.
	Press to search a particular database record by date.
	Press to search a particular database record by name.
	Press to search a particular database record by code.
	Press to print a database record.
	Press to export control and average tare reports for PGC mode.
	Press to clear edit box content.

	Press to enable/disable an on-screen keyboard.
	Press to read printout template saved to *.lb file (the button becomes active upon connecting the USB flash drive).
	Press to save the template to *.lb file (the button becomes active upon USB flash drive connection).
	Press to select printout template variables out of the list.

7.2. Return to Weighing

Introduced modifications are automatically recorded upon return to the home screen. To return to the home screen:

- press  key repeatedly, keep pressing the key until you see the home screen,
- press either  button or  field, both located in the top bar, the home screen is displayed immediately.

8. INSTALLER INSTRUCTION

The PUE HY10 indicator can be a base component of a load cell scale.

8.1. Connecting Platform Equipped With 6-Wire Load Cells

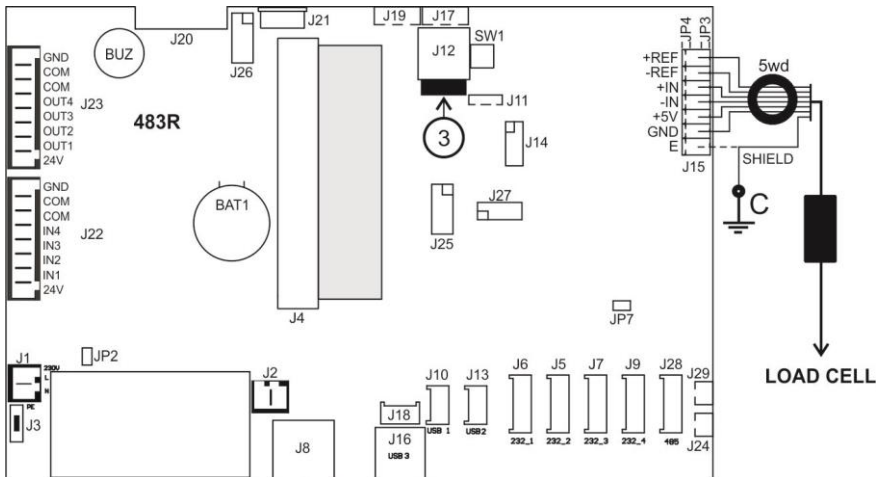

6-wire load cell connection

Radwag A/D converter board	Load cell signals	NOTES
E	SHIELD	
REF+	SENSE +	JP3 not to be soldered
REF-	SENSE -	JP4 not to be soldered
IN+	OUTPUT+	
IN-	OUTPUT-	
+5V	INPUT+	
AGND	INPUT-	

8.2. Connecting Platform Equipped With 4-Wire Load Cells

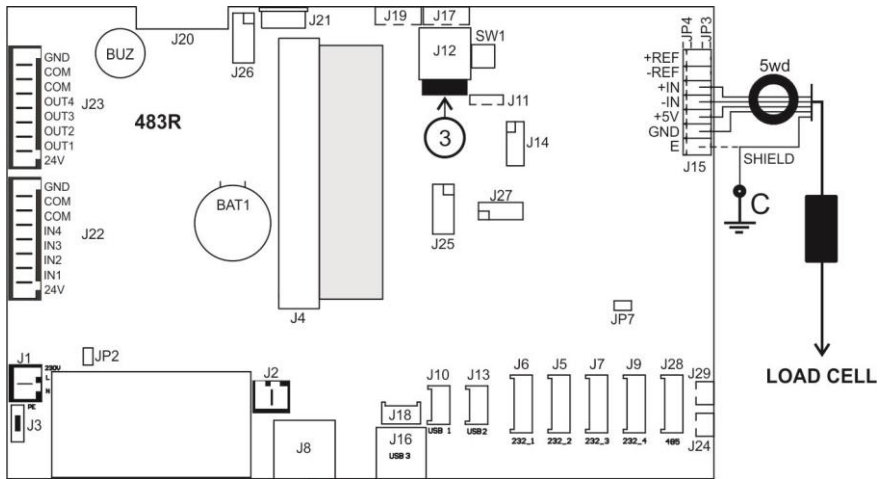

4-wire load cell connection

Radwag A/D converter board	Load cell signals	NOTES
E	SHIELD	
REF+	-	JP3 soldered
REF-	-	JP4 soldered
IN+	OUTPUT+	
IN-	OUTPUT-	
+5V	INPUT+	
AGND	INPUT-	

8.3. Connecting Signal Cable's Shield With the Platform

To ensure correct scale operation, follow the below instructions regarding connection of the load cell's signal cable shield. The rules are valid for 6- and 4-wire cables.

	Scale with an indicator in a metal housing, the indicator connected with a platform via a load cell signal cable.	Scale of a compact mechanical design in a metal housing, the indicator connected with a platform via a post, etc.
Platform without galvanic connection of the signal cable's shield	POINT C	E
Platform with galvanic connection of the signal cable shield.	POINT C	POINT C

Point C – threaded pin, connected with the indicator's housing galvanically, (for fixing of the ring terminal).

E – terminal for a load cell cable shield connected to J15 connector.

8.3.1. Checking Connection of Load Cell's Shield

The test is carried out using ohmmeter.

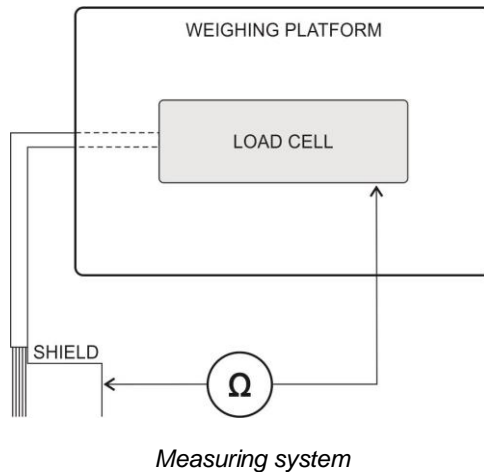

9. FACTORY SETUP

To access and modify factory settings and parameters that are made available for a user, run Factory Setup mode. Running Factory Setup mode enables the user to define the scale.

9.1. Factory Setup Access

- Press **ON/OFF** switch to power the indicator, the switch is to be found at the back of the housing, wait for the operating system to be loaded.
- Upon completed start-up, the home screen is displayed automatically.
- Press internal micro switch, **SW1**:

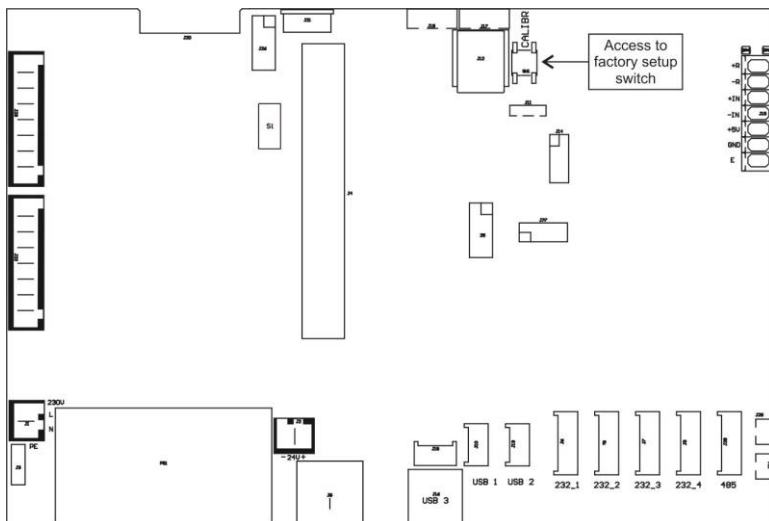

Factory Setup access switch

- Press  button to enter the main menu. Two submenus are displayed: **Global, Factory**.

9.2. Global Parameters

NAME	DEFAULT	VALUES	DESCRIPTION
Top bar - metrology	-	-	Activation of metrological data in the top bar of the home screen (read section 9.4).
Platform quantity	1	1 ÷ 6	Weighing platform quantity.
Weighing module type	Standard	-	Declaring type of the weighing module connecting with the indicator (read section 11).
Verified	<input checked="" type="checkbox"/> No	<input checked="" type="checkbox"/> No, <input checked="" type="checkbox"/> Yes	Declaring whether the scale is verified or not.
Request modules pairing	<input checked="" type="checkbox"/> Yes	<input checked="" type="checkbox"/> No, <input checked="" type="checkbox"/> Yes	Enabling/disabling pairing of modules connecting with PUE HY10 indicator.

NTEP	✔	✔ No, ✔ Yes	Enabling/disabling modifications in „Parts Counting” mode for verified scales (USA market).
Converter speed	25	6.25, 12.5, 25, 50, 100	Converter rate change.
g-cor.	1	-	Determining gravitational correction value (read section 9.7).
Serial number	0	-	Serial number of the scale.
Additional communication module	-	Profibus, Profinet, Analog module RS485, RS232(3)	Enabling/disabling additional communication module.
Weighing data storage period [days]	0	-	Protection against deleting data from weighing, PGC and average tare databases, data storage period is given in days.
Service	-	-	Service mode.
Advanced settings	-	-	Submenu containing advanced service settings.
Working mode accessibility	-	-	Enabling/disabling access to particular working modes.
Menu accessibility	-	-	Enabling/disabling access to the following submenus: Display, Printouts, Inputs/Outputs, Import/Export.
Databases accessibility	-	-	Enabling/disabling accessibility of selected databases.
Reports accessibility	-	-	Enabling/disabling accessibility of selected reports.
Database configuration	-	-	Database setup submenu (read „PUE HY10 indicator software manual”).
[ct] available	✔ No	✔ No, ✔ Yes	Enabling/disabling metrological parameters, given in [ct] unit, in the top bar of the home screen.
Supplementary units	✔ Yes	✔ No, ✔ Yes	Enabling/disabling supplementary unit operation.
Rounded tare mode	✔ No	✔ No, ✔ Yes	Enabling/disabling rounded tare mode.
Tare lockout	✔ No	✔ No, ✔ Yes	Enabling/disabling tare function.
Import	-	-	Import of parameters from a USB flash drive.
Export	-	-	Export of parameters to a USB flash drive.
Export of system events	-	-	Export of 'system events' to a USB flash drive.

Set default scale configuration	-	-	Setting default scale configuration (button functions, printouts, text information).
Reset to factory default settings	-	-	Restoring default global settings.

9.3. Factory Parameters

NAME	DEFAULT	VALUES	DESCRIPTION
Metrology	-	-	Metrology related settings
Reading unit: range 1	0.001	0,001 ÷ 50	Rounding of the last digit and position of a decimal point for weighing range I.
Reading unit: range 2	0.001	0,001 ÷ 50	Rounding of the last digit and position of a decimal point for weighing range II.
Reading unit: range 3	0.001	0,001 ÷ 50	Rounding of the last digit and position of a decimal point for weighing range III.
Range	6.009	-	Maximum capacity + overload.
Range 2 *	0.000	-	Switching point of range II.
Range 3 **	0.000	-	Switching point of range III.
Adjustment weight mass	2	-	Adjustment weight mass.
Adjustment unit	kg	g, kg, lb	Adjustment unit.
g-cor.	1	-	Gravitational correction value.
Autozero range	0,25	0,1 ÷ 5	Autozero range (in divisions).
Stability range	1	0,1 ÷ 5	Stability range in [d] units.
Stability time	0,8	0 ÷ 20	Stability time in [s].
Start mass control	1	0, 1, 2	Start mass control: 0 – off, 1 – range: from -5% to +15% of start mass, 2 – range ±20% of start mass.
Digit marker	No	Yes, No	Enabling/disabling digit marker.
Adjustment	-	-	Adjustment process (read section 9.5).
Start mass determination	-	-	Determining platform start mass.
Adjustment	-	-	Platform calibration process.
Start mass	-	-	Start mass value (in divisions).
Adjustment factor	100	-	Adjustment factor.
External adjustment weight			Mass of an external adjustment weight.



Linearity	-	-	Linearity correction (read section 9.6).
Determine	-	-	Determining linearity correction points.
Delete	-	-	Deleting linearity correction.
Corrections	-	-	Entering corrections for linearity correction points.
Information	-	-	Information (read-only).
Serial number	0	-	Preview of scale serial number.
Reading unit: range 1	0.001	-	Preview of unit value of range I.
Reading unit: range 2	0.001	-	Preview of unit value of range II.
Range	6.009	-	Preview of range I value.
Range 2	0.000	-	Preview of range II value.
Weighing firmware version	-	-	Version of the weighing module software.
Divisions	-	-	Display of A/D converter divisions.
Set default	-	-	Restoring platform's factory settings.

*) - For I-range scales set 0,

***) - For I- or II-range scales set 0 value.

	<p><i>The above table presents menu structure for one platform. When more than one platforms are in use, enter <Factory parameters> menu to see a list of all the platforms. Each platform is defined by an analogous set of parameters (see the above table).</i></p>
---	---







9.4. Metrological Data

- Enter <  **Global** /  **Top bar – metrology**> submenu, set required values:

PARAMETER NAME	DEFAULT	VALUES	DESCRIPTION
Activation	No	Yes, No	Enabling/disabling display of metrological data in the top bar of the home screen.
Scale type	-	PUE HY10, HTY, HRP	Selecting scale type, the scale type is conditioned by an indicator type.
Scale name	-	-	Special name and/or name of RADWAG distributor's device (6 characters maximum). The name entered for this parameter replaces the selected "Scale type" value.

9.5. Factory Adjustment







9.5.1. External Adjustment

- Enter <  /  **Factory** /  **Adjustment**> submenu and go to <  **Adjustment**> parameter.
- Unload the platform.
- Message <**Unload the platform**> is displayed.
- Press  button. Start mass is determined, message <**Start mass determination**> is displayed.
- Upon completed start mass determination procedure, message <**Load xxx**> is displayed (where: xxx – the adjustment weight mass).
- Load the platform with the required adjustment weight and press  button.
- Upon completed procedure, message <**Operation completed successfully**> is displayed.
- Press  button to confirm and return to weighing, saving changes.



Adjustment of platform 2, 3, 4, 5, 6 is analogous.

9.5.2. Start Mass Determination

- Enter <  /  **Factory** /  **Adjustment**> submenu and go to <  **Start mass determination**> parameter.
- Unload the platform.
- Message <**Unload the platform**> is displayed.
- Press  button. Start mass is determined, message <**Start mass determination**> is displayed.
- Upon completed procedure, message <**Operation completed successfully**> is displayed.
- Press  button to confirm and return to weighing, saving changes.











Start mass determination for platform 2, 3, 4, 5, 6 is analogous.

9.6. Linearity Correction

9.6.1. Linearity Determination

Determining mass for each step of the linearity and corrections via scale software.

Procedure:

- Enter <  **Factory/**  **Linearity**> submenu and go to <**Determine**> parameter. <**Mass**> dialog box and an on-screen keyboard opens.
- Unload the platform.
- Enter the required mass value (the first linearity correction point) and press  button to confirm. Message <**Load xxx**> is displayed (where: xxx – the entered mass value).
- Make sure that the weighing pan is unloaded,  and  pictograms must be displayed, if not press  key to zero the scale.
- Load the weighing pan with weight of mass equal to weight value specified for the first linearity correction point, wait for a stable indication and press  button.
- <**Mass**> dialog box with an on-screen keyboard opens, declare the next linearity correction point.
- Proceed likewise for the second linearity correction point. Scale software enables determining 6 linearity correction points maximum.
- Upon confirmation of the last (sixth) linearity correction point, <**Linearity**> submenu is displayed automatically.
- If you want to declare less than 6 points, press  button of <**Mass**> dialog box.
- <**Linearity**> submenu is displayed automatically.
- Return to weighing, saving changes.







Shall zero value be confirmed, by pressing  button, as a linearity correction point, message <Value too low> is displayed.

9.6.2. Corrections



Editing correction values for particular linearity points.

Procedure:

- Enter <  **Factory /**  **Linearity**> submenu.

- Select **<Corrections>** parameter. A list of determined linearity correction points is displayed. The list contains previously declared mass values for each correction point and deviations, given in reading units.
- Select a respective entry, **<Mass>** dialog box with an on-screen keyboard, providing a previously declared mass value is displayed.
- Make sure that the weighing pan is unloaded,  and  pictograms must be displayed, if not press  key to zero the scale.
- Load the weighing pan with the declared mass and press  button.
- **<Correction>** dialog box with an on-screen keyboard opens automatically.
- If the declared value differs from the displayed stabilised value then a respective correction needs to be entered, use the on-screen keyboard.
- If there is a need to enter negative value, write „-“ sign before the number.
- Press  button to confirm, list of linearity correction points is displayed again.
- Proceed likewise for the next linearity correction point.
- Return to weighing, saving changes.

9.6.3. Deleting Linearity

- Enter  **<Factory /  Linearity>** submenu.
- Select **<Delete>** parameter. Message **<Delete?>** is displayed.
- Press  button to confirm.
- Return to weighing, saving changes.

9.7. Gravitational Correction

The function of gravitational correction compensates changes of earth gravity being a result of different latitude and longitude. It enables correct calibration of the weighing device away from the place of use. The value of gravitational correction can be:

- entered if known,
- determined by gravitational acceleration method,
- determined by latitude method.

9.7.1. Entering the Gravitational Correction Value



The gravitational correction value must be entered with reference to tables prepared by „Radweg Balances and Scales” or calculated using the below formula:

$$g - \text{COR.} = \frac{g_{\text{uzyt.}}}{g_{\text{kal.}}}$$



If the scale is calibrated at the place of use then the gravitational correction value (<g-cor.> parameter) is 1.00000. If the scale is calibrated away from the place of use (longitudinal change) the value of <g-cor.> parameter must be corrected.

Procedure:





- Enter < **Factory** /  **Metrology**> submenu.
- Select <**g-cor.**> entry, <**g-cor.**> dialog box with an on-screen keyboard opens.
- Enter a respective value and press  button to confirm.
- Return to weighing, saving changes.



9.7.2. Gravitational Acceleration Method

The method consists in automatic calculation of the value of gravitational correction, <**g-cor.**>, on the basis of:

- gravitational acceleration of the place where the calibration/adjustment is carried out,
- gravitational acceleration of the place of use.

Procedure:

- Enter < **Global** /  **g-cor.**> submenu.
- Select <**g-cor. method**> entry, <**Enter g-cor. value for adjustment place**> dialog box with an on-screen keyboard opens, the box provides value of gravitational acceleration for RADOM city in Poland.
- If the scale is adjusted in RADOM, press  button to confirm the displayed value.
- If the scale is adjusted elsewhere, enter the value respective for a particular spot and press  button to confirm.
- <**Enter g-cor. value for place of use**> dialog box with an on-screen keyboard opens automatically.
- Enter a respective value and press  button to confirm, a message providing the calculated <**g-cor.**> (gravitational correction) value is displayed.











- Press  button to confirm, the newly calculated gravitational correction value is automatically attributed to **<g-cor.>** parameter of  **Factory** /  **Metrology**> submenu.
- Return to weighing, saving changes.

9.7.3. Latitude Method

The method consists in automatic calculation of value of gravitational correction, **<g-cor.>**, on the basis of:

- gravitational acceleration of the place where the calibration/adjustment is carried out,
- degrees of latitude of the place of use,
- minutes of latitude of the place of use,
- altitude of the place of use.



Procedure:

- Enter  **Global** /  **g-cor.**> submenu.
- Select **<Latitude method>** entry, **<Enter g-cor. value for adjustment place>** dialog box with an on-screen keyboard opens, the box provides value of gravitational acceleration for RADOM city in Poland.
- If the scale is adjusted in RADOM, press  button to confirm the displayed value.
- If the scale is adjusted elsewhere, enter the value respective for a particular spot and press  button to confirm.
- **<Enter latitude degrees for place of use>** dialog box with an on-screen keyboard opens automatically.
- Enter a respective value and press  button to confirm, **<Enter latitude minutes for place of use>** dialog box with an on-screen keyboard opens automatically.
- Enter a respective value and press  button to confirm, **<Enter altitude for place of use>** dialog box with an on-screen keyboard opens automatically.
- Enter a respective value and press  button to confirm; a message providing the calculated **<G>** (gravitational acceleration coefficient for a place of use) and **<g-cor.>** (gravitational correction) values is displayed.
- Press  button to confirm, the newly calculated gravitational correction value is automatically attributed to a respective parameter of  **Factory** /  **Metrology**> submenu.
- Return to weighing, saving changes.

9.8. Declaring Verified Scale

Some special functions of the program are restricted for verified scales. **<Verified>** parameter has been introduced in order to automatically lock access to the restricted functions. **<Verified>** parameter must be set to **<No>** value for users who do not need to use verified scale, with this their device functionality is boosted.

Procedure:

- Enter  **Global /**  **Verified>** submenu and set a respective value (✔ - verified scale, ✔ - non-verified scale).

10. OPTIONAL EXTENSION MODULES

10.1. Additional 12IN/12OUT

The module has been designed to expand indicator's functionality by additional 12 inputs and 12 outputs. It is equipped with optoisolated inputs and semiconductor outputs and enables free configuration of both the inputs and outputs (using indicator menu). For 12IN/12OUT module, the indicator's housing cover features two cable glands through which 3-meter long leads, terminated with strip wires, are fed.

10.1.1. Technical Specifications

Output parameters	
Output quantity	12
Output type	Solid-state relay
Cable cross-section	0.14 - 0.5 mm ²
Maximum output current	0.5 A DC
Maximum output voltage	30 VDC, AC
Input parameters	
Input quantity	12
Input type	Optoisolated
Cable cross-section	0.14 - 0.5 mm ²
Input voltage range	5 -24V DC

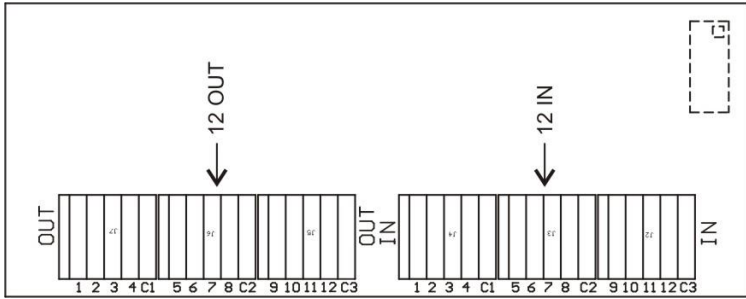

12IN/12OUT module

10.1.2. 12IN/OUT Schematic Diagrams

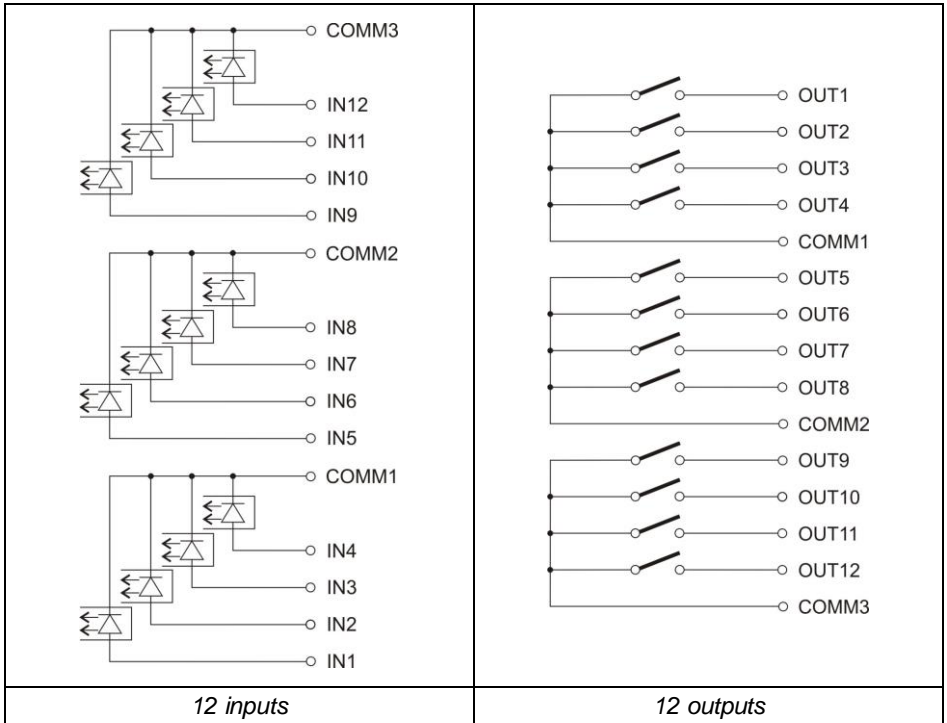

10.1.3. Input / Output Signals

The signals are sent via 16x0.5 mm² cable with numbered wires.

INPUTS		OUTPUTS	
Wire number	Signal	Wire number	Signal
1	IN1	1	OUT1
2	IN2	2	OUT2
3	IN3	3	OUT3
4	IN4	4	OUT4
5	COMM1	5	COMM1
6	IN5	6	OUT5
7	IN6	7	OUT6
8	IN7	8	OUT7
9	IN8	9	OUT8
10	COMM2	10	COMM2
11	IN9	11	OUT9
12	IN10	12	OUT10
13	IN11	13	OUT11
14	IN12	14	OUT12
15	COMM3	15	COMM3

10.2. 4IN/4OUT Module

Signals are transmitted via cables fed through cable glands.

10.2.1. Technical Specifications

Output parameters	
Output quantity	4
Output type	Solid-state relay
Cable cross-section	0.14 - 0.5 mm ²
Maximum output current	0.5 A DC
Maximum output voltage	30 VDC, AC
Input parameters	
Input quantity	4
Input type	Optoisolated
Cable cross-section	0.14 - 0.5 mm ²
Input voltage range	5 - 24 VDC

10.2.2. 4IN/4OUT Schematic Diagram

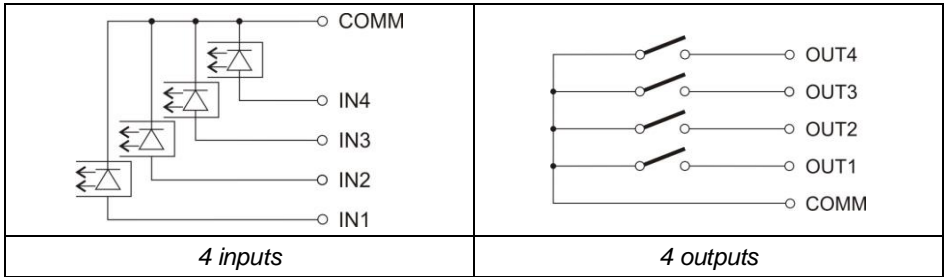

10.2.3. Input / Output Signals

INPUTS		OUTPUTS	
WIRE NUMBER	SIGNAL	WIRE NUMBER	SIGNAL
1	IN1	1	OUT1
2	IN2	2	OUT2
3	IN3	3	OUT3
4	IN4	4	OUT4
5	COMIN	5	COMOUT
6	GNDIN	6	GNDOUT
7	+24 VDC	7	+24 VDC

10.3. AN Analog Output Module

AN module operates in three different modes:

- AN 0 - 10 V.
- AN 4 - 20 mA.
- AN 0 - 20 mA.

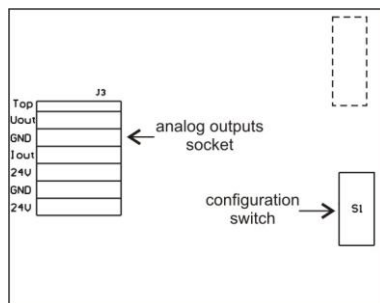

AN analog output module

10.3.1. AN Module Configuration

The module's working mode is set using **S1** switch, when setting the module's working mode refer to the below table. Analog output module board provides description of settings, for the description look around **S1** switch.

R1	R2	WORKING MODE
0	0	0-10V
0	1	4-20mA
1	0	0-20mA
1	1	0-24mA

BY DEFAULT SET ANALOG OUTPUT MODULE TO 4 - 20 mA MODE.

Analog output must be calibrated (adjusted); using P1 potentiometer set the correct offset (e.g. for 4 - 20mA output, adjust current so that for 0kg indication it is precisely 4mA). In case of remaining operation modes proceed analogously.

10.3.2. Technical Specifications

Working mode	4 - 20 mA , 0 - 20 mA, 0 - 10 V
Resolution	16 bit
Current output resistance	< 500 Ω
Voltage output resistance	> 400 Ω
Power supply	24 VDC (12 - 30 V DC), max 40 mA

10.3.3. Wiring Diagrams

Voltage output wiring diagram

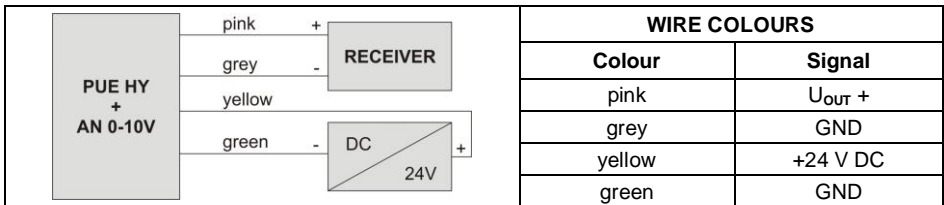

Current output wiring diagram

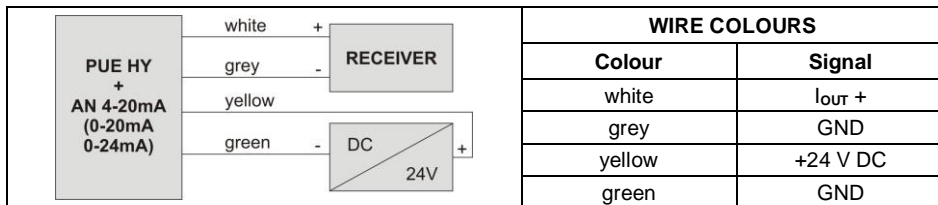

10.4. Additional Platform Module, DP6

The 'DP4' module expands indicator functionality, with it an additional platform can be operated. The module is intended to be mounted inside the indicator. For DP6 module (484R board), the indicator's housing cover features an additional cable gland through which additional platform cable is fed.

10.4.1. Technical Specifications

Operating temperature	-10 °C ÷ 40 °C
OIML class	III
Verification unit quantity	6000
Maximum input signal	19.5 mV
Maximum voltage per verification unit	3.25 µV
Minimum voltage per verification unit	0.4 µV
Minimum load cell impedance	50 Ω
Maximum load cell impedance	1200 Ω
Load cell power supply	5 V
Load cell wiring	4 or 6 wires + Shield
Multi-range option	YES

10.4.2. Colours of Weighing Platform's Signal Wires

RADWAG Markings	Colour	Marking of terminals (solder pads) on RADWAG A/D converter boards
+INPUT	brown	+5V
-INPUT	green	AGND
+OUTPUT	yellow	+IN
- OUTPUT	white	-IN
SENSE	grey	+REF

- SENSE	pink	- REF
SHIELD	yellow-green	by shield connection guidelines

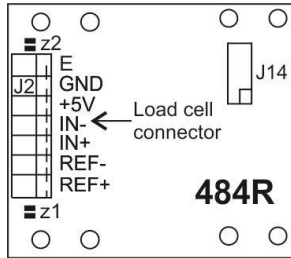

Module of an additional A/D DP6 converter*

10.5. RS485 Module (309R)

The PUE HY10 indicator can be equipped with RS485 interface (option). This requires installation of **309Rxxxx** board in U1 socket of the universal communication modules board (385Rxxxx board, ver. B).

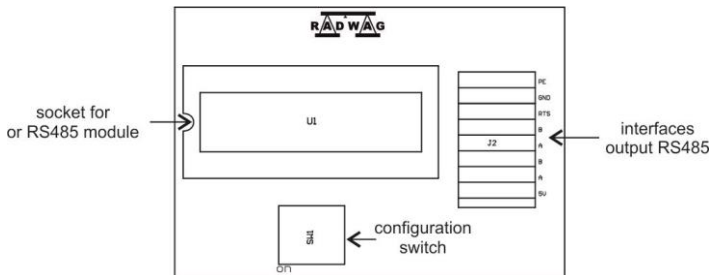

Position of RS485 module on 385R board ver. B.

	<p>It is not possible to install PROFIBUS or PROFINET module and RS485 module on the main board simultaneously. The modules are installed interchangeably in the same socket of the main board, 483R.</p>
--	--

10.6. PROFIBUS module

The PUE HY10 indicator can be equipped with PROFIBUS interface (option). This requires installation of **AB6000 Anybus-IC** module (Elmark Automatyka) in U1 socket of universal communication modules board (385R board, ver. A).

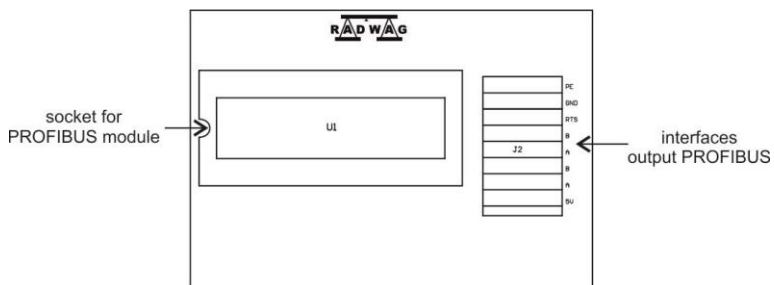

Position of PROFIBUS module on 385R board ver.A

The indicator is equipped with input and output connectors. On the output connector there is 5 VDC voltage, this provides correct operation of a terminator. Connectors of M12 5 pin B-code standard are used (for PROFIBUS DP).

Pin arrangement

PROFIBUS IN (male)		Pin1 – NC Pin2 – A Pin3 – NC Pin4 – B Pin5 – NC
PROFIBUS OUT (female)		Pin1 - +5V Pin2 – A Pin3 – GND Pin4 – B Pin5 – NC

	<p><i>It is not possible to install RS485 or PROFINET module and PROFIBUS module on the main board simultaneously. The modules are installed interchangeably in the same socket of the main board, 483R.</i></p>
--	---

10.7. PROFINET Module

The PUE HY10 indicator can be equipped with PROFINET interface (option). This requires installation of **AB6005 Anybus-IC** module (Elmark Automatyka) in U1 socket of universal communication modules board (386R board).

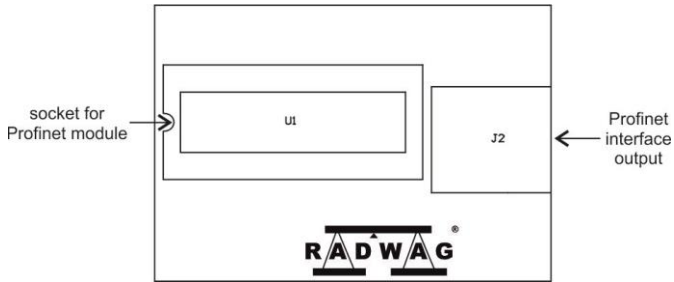

Position of PROFINET module on 386R board

The indicator is equipped with an additional RJ45 connector with PROFINET description.

For detailed description of PROFINET interface settings read the „**PUE HY10 Indicator Software Manual**”, and for communication protocol description read the „**PROFINET Communication Protocol User Manual**”.

	<p><i>It is not possible to install RS485 or PROFIBUS module and PROFINET module on the main board simultaneously. The modules are installed interchangeably in the same socket of the main board, 483R.</i></p>
--	---

10.8. Additional Modules Positioning

It is possible to install different modules to one and the same socket on the main board. Installation requirements are to be found in exclusion table (read section 10.9). Exemplary assignment of modules on 483R board:

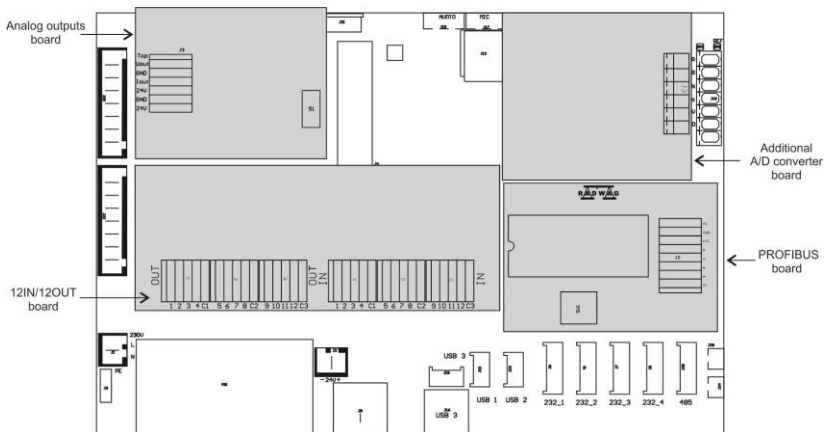



Additional modules arrangement

10.9. Exclusions Regarding Installation of Additional Modules

INSTALLED MODULE	EXCLUDED MODULES
12IN/OUT	-
ANxxxx	-
PROFIBUS	RS485, PROFINET
RS485	PROFIBUS, PROFINET
PROFINET	RS485, PROFIBUS
Additional platform DP6	-

11. ANNEX A - Communication with Modules Taking Function of an Additional Weighing Platform

In order to declare type of a weighing module connecting with the PUE HY10 indicator go to: <  /  **Global**> submenu.

	<p><i>Weighing module's transmission parameters (baud rate, computer port) and PUE HY10 indicator's transmission parameters must be compatible. Configuration of transmission parameters of weighing modules connecting with PUE HY10 indicator is to be found in user manual of a particular scale.</i></p>
---	---

11.1. Communication with a Weighing Module Supporting 'Scale with NT Command' Protocol'

Communication between **PUE HY10** indicator and a weighing module supporting „**Scale with NT Command**” protocol is carried out via RS232 or Ethernet interface.

Compatible weighing instruments:

- AS X2, AS R, AS 3Y balances.
- PS X2, PS R, PS 3Y, PM balances.
- APP X2, APP R, APP 3Y balances.
- WLC, WTC, C315 scales.
- MAS, MPS weighing modules.

Procedure:

- Connect the associated device to the PUE HY10 indicator using RS232 cable, switch both devices on.
- Enter global parameters submenu of the PUE HY10 indicator.
- Go to **<Weighing module type>** parameter and select the required weighing module number.
- Select the associated device from the list. Message **<Restart to implement changes>** is displayed.
- Press  button to confirm and return to weighing, saving changes, next restart the device.
- Enter factory parameters submenu of the PUE HY10 indicator.
- Go to a modified submenu of the weighing platform, list of the following parameters is displayed:

NAME	DEFAULT	VALUES	DESCRIPTION
Port *	None	None, RS232 (1), RS232 (2)	Declaring number of RS232 port of PUE HY10 indicator for communication with the associated device.
IP Address	0.0.0.0	-	Declaring IP address of PUE HY10 indicator for communication with the associated device.
IP port	0	-	Declaring IP port of PUE HY10 indicator for communication with the associated device via Ethernet.(by default: 4001).
Reading unit: range 1	0.001	0,001 ÷ 50	Rounding of the last digit and position of a decimal point for range I of the associated device.
Reading unit: range 2	0.001	0,001 ÷ 50	Rounding of the last digit and position of a decimal point for range II of the associated device.
Reading unit: range 3	0.001	0,001 ÷ 50	Rounding of the last digit and position of a decimal point for range III of the associated device.
Range	0	-	Weighing range of the associated device.
Range 2	0	-	Switching point of weighing range II of the associated device.
Range 3	0	-	Switching point of weighing range III of the associated device.
Adjustment unit	G	g, kg, lb	Adjustment unit of the associated device.
Refresh *	-	-	Automatic readout of metrology parameters from the associated device.

*) - Transmission parameters of PUE HY10 indicator must be compatible with the associated device. To set transmission parameters of PUE HY10 go to „**SETUP/ Communication**” submenu.

- Set respective parameter values and return to weighing, saving changes.

11.2. Communication with MW-01 Weighing Module

Connection between PUE HY10 indicator and MW-01 weighing module requires:

- establishing communication between the PUE HY10 and the MW-01,
- editing and record of transmission parameters, and all factory parameters, to the MW-01 module memory, using the PUE HY10 indicator.

11.2.1. Establishing Communication Between PUE HY10 and MW-01



Connection between PUE HY10 indicator and MW-01 weighing module is carried out via **RS232** or **Ethernet** interface.

Procedure:

- Connect the MW-01 module to the PUE HY10 indicator using RS232 or Ethernet cable (conditioned by model), and switch both devices on.
- Enter global parameters submenu of the PUE HY10 indicator.
- Go to **<Weighing module type>** parameter and select the required weighing module number.
- Select **<MW-01>** from the list. Message **<Restart to implement changes>** is displayed.
- Press  button to confirm and return to weighing, saving changes, next restart the device.
- Enter factory parameters submenu of the PUE HY10 indicator.
- Go to a modified submenu of the weighing platform.
- Enter „**Miscellaneous / PUE Y: Communication**” submenu, list of the following parameters is displayed:

NAME	DEFAULT	VALUES	DESCRIPTION
Port *	None	None, Tcp, RS232 (1), RS232 (2)	Declaring port type of PUE HY10 indicator for communication with MW-01 module.
Address	0	-	Declaring address of PUE HY10 indicator for communication with MW-01 module (default address value in MW-01 module is 1).
IP Address	0.0.0.0	-	Declaring IP address of PUE HY10 indicator for communication with MW-01 module via Ethernet (by default the IP address value in MW-01 module is 192.168.0.2).
IP port	0	-	Declaring IP port of PUE HY10 indicator for communication with MW-01 module via Ethernet (by default the IP port value in MW-01 module is 4001)

*) - In case of connection via RS232, the default value of baud rate for MW-01 weighing module is **57600bit/s**.

	Declaring RS232 or TCP port of PUE HY10 indicator for communication with MW-01 module requires respective transmission parameters to be set for these ports.
	MW-01 module's transmission parameters and transmission parameters of PUE HY10 indicator's ports must be compatible. To set transmission parameters of PUE HY10 indicator's ports go to „SETUP/ Communication” submenu.

- Set respective parameter values and return to weighing, saving changes.

11.2.2. Defining Transmission Parameters for MW-01 Weighing Module

In order to set transmission parameters for MW-01 weighing module it is necessary to put a jumper onto the module's main board:

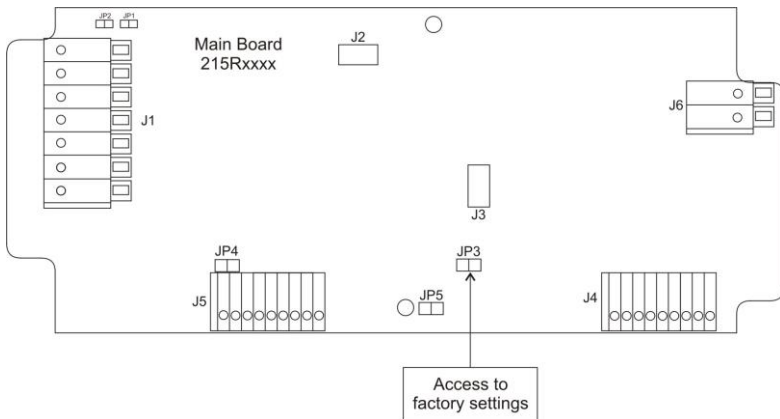

Procedure:

- Make sure that communication between the PUE HY10 and the MW-01 is established, enter factory parameters submenu of the PUE HY10 indicator.
- Go to a modified submenu of the weighing platform.
- Enter „Misc./ MW-01: Communication” submenu, list of the following parameters is displayed:

NAME	DEFAULT	VALUES	DESCRIPTION
Address	1	-	Setting address of MW-01 module.
IP Address	192.168.0.2	-	Setting IP address of MW-01 module.
Subnet mask	255.255.255.0	-	Setting subnet mask of MW-01 module.

Default gateway	192.168.0.1	-	Setting default gateway of MW-01 module.
Port	4001	-	Setting local port of MW-01 module.
Timeout	0	0÷300s	Setting time interval after passage of which an inactive Ethernet connection gets broken.

- Set respective parameter values and return to weighing, saving changes.

	<i>In order to save changes it is necessary to restart MW-01 weighing module.</i>
---	--

11.2.3. Defining Factory Settings for MW-01 Weighing Module

	<i>In order to set factory parameters for MW-01 weighing module it is necessary to put a jumper onto the module's main board (read section 11.2.2).</i>
---	--

- Make sure that communication between the PUE HY10 and the MW-01 is established, and enter factory parameters submenu of the PUE HY10 indicator.
- Go to a modified submenu of the weighing platform, list containing factory parameter values read from the MW-01 weighing module is displayed:

NAME	VALUES	DESCRIPTION
Metrology	-	Metrology-related settings.
Reading unit: range 1	0.001 ÷ 50	Rounding of the last digit and position of a decimal point for range I.
Reading unit: range 2	0.001 ÷ 50	Rounding of the last digit and position of a decimal point for range II.
Reading unit: range 3	0.001 ÷ 50	Rounding of the last digit and position of a decimal point for range III.
Range	-	Weighing range of MW-01 module.
Range 2	-	Switching point of weighing range II.
Range 3	-	Switching point of weighing range III.
Adjustment weight mass	-	Adjustment weight mass.
Adjustment unit	g, kg, lb	Adjustment unit.
g-cor.	-	Gravitational correction value.
Autozero range	0.1 ÷ 5	Autozero range (in divisions).
Stability range	0.1 ÷ 5	Stability range in [d] units.
Stability time	0 ÷ 5	Stability time in [s].

Start mass control	0, 1, 2	Start mass control: 0 – disabled, 1 – range: from -5% to +15% of start mass, 2 – range: from -20% to +20% of start mass,
Digit marker	No, Yes	Enabling/disabling digit marker.
Converter speed	6.25, 12.5, 25, 50, 100, 200, 400, 800, 1600, 3200	Converter rate, set depending on the intended use of MW-01 module, used for dynamic scales (default value: 6.25).
Adjustment	-	Adjustment process.
Start mass determination	-	Determining start mass of MW-01 module (the procedure is likewise to the one described in section 9.5).
Adjustment	-	MW-01 module adjustment (the procedure is likewise to the one described in section 9.5).
Start mass	-	Start mass (in divisions).
Adjustment factor	-	Adjustment factor.
Linearity	-	MW-01 module linearity correction (the procedure is likewise to the one described in section 9.6).
Determine	-	Determining linearity correction points.
Delete	-	Deleting linearity correction.
Corrections	-	Entering corrections for determined linearity correction points.
Information	-	Information (read-only).
Serial number	-	Serial number of MW-01 module.
Weighing firmware version	-	Preview of MW-01 module's software version.
Divisions	-	Displaying A/D converter divisions.
Miscellaneous	-	Miscellaneous parameters.
Pue7: Communication	-	Group of parameters for communication between PUE HY10 indicator and MW-01 module (read section 11.2.1).
MW-01: Communication	-	Group of parameters enabling modification of transmission parameters for MW-01 module using PUE HY10 indicator (read section 11.2.1).
Set default	-	Restoring default settings of MW-01 module.

- Set respective parameter values and return to weighing, saving changes.

11.3. Communication with HRP Weighing Module

Connection between PUE HY10 indicator and HRP weighing module requires:

- establishing communication between the PUE HY10 and the HRP module,
- editing and record of transmission parameters, and all factory parameters, to the HRP module memory, using the PUE HY10 indicator.

11.3.1. Establishing Communication Between PUE HY10 and HRP



Connection between PUE HY10 indicator and HRP weighing module is carried out via **RS232**, **RS485** or **Ethernet** interface.

Procedure:

- Connect the HRP module to the PUE HY10 indicator using a dedicated RS232, RS485 or Ethernet cable (list of connection cables is to be found in service manual of the HRP module).
- Switch the PUE HY10 indicator on and enter global parameters submenu.
- Go to **<Weighing module type>** parameter and select the required weighing module number.
- Select **<HRP>** from the list. Message **<Restart to implement changes>** is displayed.
- Press  button to confirm and return to weighing, saving changes, next restart the device.
- Enter factory parameters submenu of the PUE HY10 indicator.
- Go to a modified submenu of the weighing platform.
- Enter „**Misc./ PUE Y: Communication**” submenu, list of the following parameters is displayed:

NAME	DEFAULT	VALUES	DESCRIPTION
Port *	None	None, Tcp, RS232 (1), RS232 (2), RS485	Declaring port type of PUE HY10 indicator for communication with the HRP module.
Address	1	-	Declaring address of PUE HY10 indicator for communication with HRP module (default address value in HRP module is 1).
IP Address	0.0.0.0	-	Declaring IP address of PUE HY10 indicator for communication with HRP module via Ethernet.
IP port	0	-	Declaring IP port of PUE HY10 indicator for communication with HRP module via Ethernet.

*) - In case of connection via RS232, the default value of baud rate for HRP weighing module is **57600bit/s**.

	<i>Declaring RS232, RS485 or TCP port of PUE HY10 indicator for communication with HRP module requires respective transmission parameters to be set for these ports.</i>
	<i>HRP module's transmission parameters and transmission parameters of PUE HY10 indicator's ports must be compatible. To set transmission parameters of PUE HY10 indicator's ports go to „SETUP/ Communication” submenu.</i>

- Set respective parameter values and return to weighing, saving changes.

11.3.2. Defining Transmission Parameters for HRP Weighing Module

	<i>In order to define transmission parameters of HRP weighing module, press an internal SW1 switch on the main board of the module. Follow HRP service manual.</i>
---	---

- Make sure that communication between the PUE HY10 and the HRP is established, and enter factory parameters submenu of the PUE HY10 indicator.
- Enter modified submenu of the weighing platform.
- Enter „**Misc. / MW-MH: Communication**” submenu. The list of parameters is displayed:

NAME	DEFAULT	VALUES	DESCRIPTION
RS232 (1)	57600	1200÷115200	Baud rate of RS232 (1) port of HRP weighing module.
RS485	57600	1200÷115200	Baud rate of RS485 port of HRP weighing module.
Address	1	-	Setting address of HRP module.
IP Address	192.168.0.2	-	Setting IP address of HRP module.
Subnet mask	255.255.255.0	-	Setting subnet mask of HRP module.
Default gateway	192.168.0.1	-	Setting default gateway of HRP module.
Port	4001	-	Setting local port of HRP module.
Timeout	60	0÷300s	Setting time after which an inactive Ethernet connection is broken.

- Set respective parameter values and return to weighing, saving changes.

	<i>In order to save changes in HRP module memory it is necessary to restart PUE HY10 indicator.</i>
---	--

11.3.3. Defining Factory Settings for HRP Module



In order to determine factory settings of HRP weighing module press an internal SW1 button on the main board of the module. Follow HRP service manual.

- Make sure that communication between the PUE HY10 and the HRP is established, enter factory parameters submenu of the PUE HY10 indicator.
- Go to a modified submenu of the weighing platform, list containing factory parameter values read from the HRP weighing module is displayed:

NAME	VALUES	DESCRIPTION
Metrology	-	Metrology-related settings.
Reading unit: range 1	0.001 ÷ 50	Rounding of the last digit and position of a decimal point for range I.
Reading unit: range 2	0.001 ÷ 50	Rounding of the last digit and position of a decimal point for range II.
Reading unit: range 3	0.001 ÷ 50	Rounding of the last digit and position of a decimal point for range III.
Verification unit: range 1	0.001 ÷ 50	Verification unit of range I
Verification unit: range 2	0.001 ÷ 50	Verification unit of range II
Verification unit: range 3	0.001 ÷ 50	Verification unit of range III
Range	-	Weighing range of HRP module.
Range 2	-	Switching point of weighing range II.
Range 3	-	Switching point of weighing range III.
Adjustment weight mass	-	Adjustment weight mass.
Adjustment unit	g, kg, lb	Adjustment unit.
g-cor.	-	Gravitational correction value.
Autozero range	0.1 ÷ 5	Autozero range (in divisions).
Stability range	0.1 ÷ 5	Stability range in [d] units.
Stability time	0 ÷ 5	Stability time in [s].
Start mass control	0, 1, 2	Start mass control: 0 – disabled, 1 – range: from -5% to +15% of start mass, 2 – range: from -20% to +20% of start mass,
Converter speed	6.25, 12.5, 25, 50, 100, 200, 400, 800, 1600, 3200	Converter rate, set depending on the intended use of HRP module.
ADC operating mode	Unipolar, bipolar	Operating mode of A/D converter.

Verified	<input checked="" type="checkbox"/> Yes, <input type="checkbox"/> No	Declaring whether the scale is verified or not.
Adjustment	-	Adjustment process.
Start mass determination	-	Determining start mass of HRP module (procedure analogous to the procedure described in section 9.5).
Adjustment	-	HRP module adjustment (the procedure is likewise to the one described in section 9.5).
Internal adjustment	-	Factory adjustment procedure carried out with the use of an internal adjustment weight.
Internal correction of temperature	-	Temperature compensation procedure carried out with the use of an internal adjustment weight.
External correction of temperature	-	Temperature compensation procedure carried out with the use of an external adjustment weight.
Start mass	-	Start mass (in divisions).
Adjustment factor	-	Adjustment factor.
Zero temperature coefficient	0.000000000000	Zero change coefficient, coefficient value is conditioned by temperature change, and determined by the software after the end of compensation.
Sensitivity temperature coefficient	0.000000000000	Sensitivity change coefficient, coefficient value is conditioned by temperature change and determined by the software after the end of compensation.
Adjustment temperature	-	Value of divisions read from the temperature sensor during the adjustment.
Start mass determination range [%]	-	Start mass value range in %.
Automatic adjustment	-	Submenu for setting the automatic internal adjustment.
Change position of internal adjustment weight	-	Parameter allowing to reposition the internal adjustment weight.
Linearity	-	HRP module linearity correction (the procedure is likewise to the one described in section 9.6).
Determine	-	Determining linearity correction points.
Delete	-	Deleting linearity correction.
Corrections	-	Entering corrections for determined linearity correction points.
Parabolic linearity	-	Correction of parabolic linearity of HRP module
Determine	-	Determining parabolic linearity correction points.

Type	Single w/o hysteresis; Single with hysteresis	Parabolic linearity type.
Coefficient A	-	Parabolic linearity coefficient A.
Coefficient B	-	Parabolic linearity coefficient B.
Multiplier	-	An experimentally determined value that approximates parabola for loads exceeding maximum mass of a weight used during the procedure.
Range	-	Mass range in divisions determining Max for to-be-determined parabola (scale calculation).
Information	-	Information (read-only).
Serial number	-	HRP module serial number.
Weighing firmware version	-	Preview of HRP module's software version.
Divisions	-	Displaying A/D converter divisions.
Temperature divisions	-	Displaying temperature divisions of the converter.
Temperature °C	-	Temperature value read from the internal sensor installed in the HRP module, given in [°C].
Start mass	-	Start mass (in divisions).
Adjustment factor	-	Adjustment factor.
g-cor.	-	Gravitational correction value.
Zero temperature coefficient	0.000000000000	Zero change coefficient, coefficient value is conditioned by temperature change, and determined by the software after the end of compensation.
Sensitivity temperature coefficient	0.000000000000	Sensitivity change coefficient, coefficient value is conditioned by temperature change and determined by the software after the end of compensation.
Adjustment temperature	-	Value of divisions read from the temperature sensor during the adjustment.
Adjustment quantity	-	Quantity of carried out adjustments.
Definable filter	-	Activating the filter and defining filter dynamics.
Update	-	Software update.
Miscellaneous	-	Miscellaneous parameters.
Scale type	heavyweight HRP, lightweight HRP, MW-MH, MPSH, MASH	Scale type / HRP module type.
Import		Parameter import.

Export		Parameter export.
Pue Y: Communication	-	Group of parameters for communication between PUE HY10 indicator and HRP module (read section 11.3.1).
MW-MH: Communication	-	Group of parameters enabling modification of transmission parameters for HRP module using PUE HY10 indicator (read section 11.3.2).
Set default	-	Restoring default HRP module settings.

- Set respective parameter values and return to weighing, saving changes.

11.3.4. Pairing of HRP Platform with PUE HY10 Indicator

Function requesting the necessity to pair HRP platform with PUE HY10 indicator.

Procedure:

- Enter **<Info / Paired modules / Pair modules>** submenu.
- The HRP platform is automatically paired with the PUE HY10 indicator, message **<Modules paired>** is displayed.
- Press  button to confirm. Serial number of the paired HRP weighing platform is displayed.

	<i><Pair modules> function is available upon activation of <Request modules pairing> parameter in <Global> submenu.</i>
---	--

12. DIAGRAMS OF CONNECTION CABLES

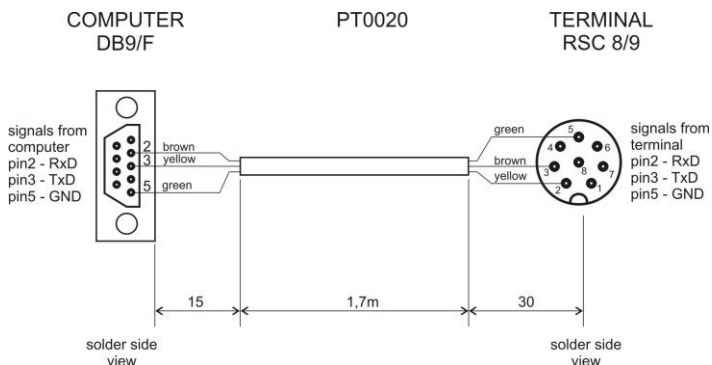

Indicator - computer cable

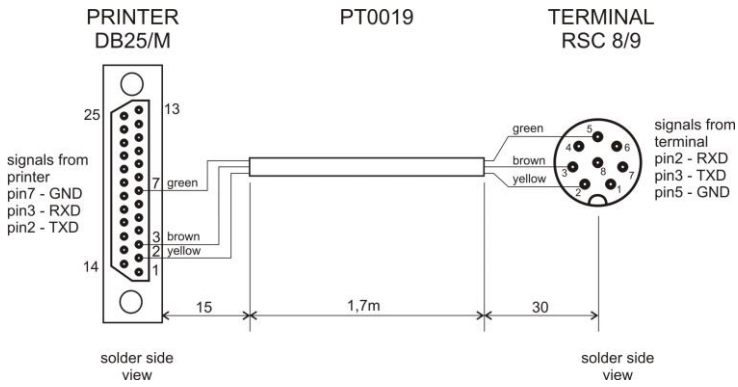

Indicator - printer cable (EPSON)

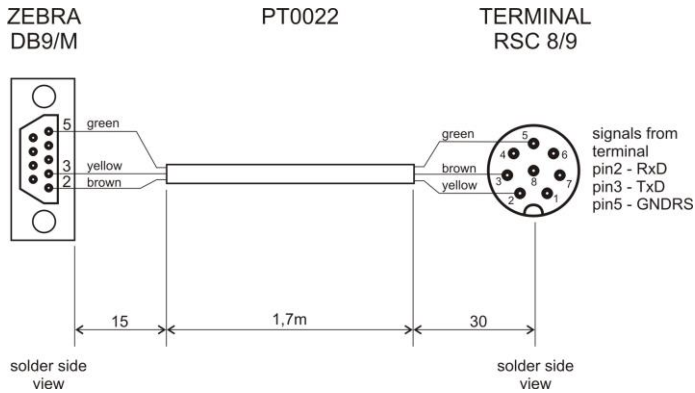

Indicator - printer cable (ZEBRA)

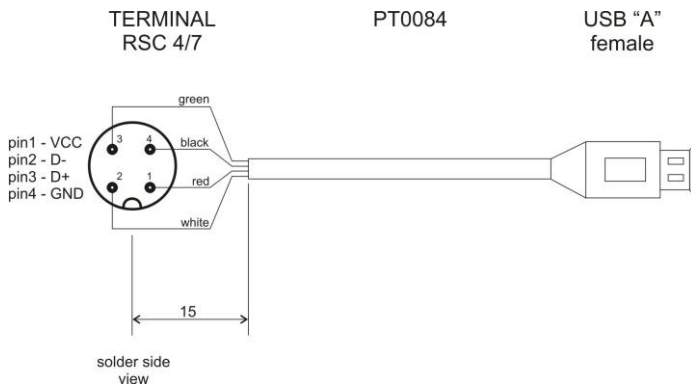

USB adapter cable

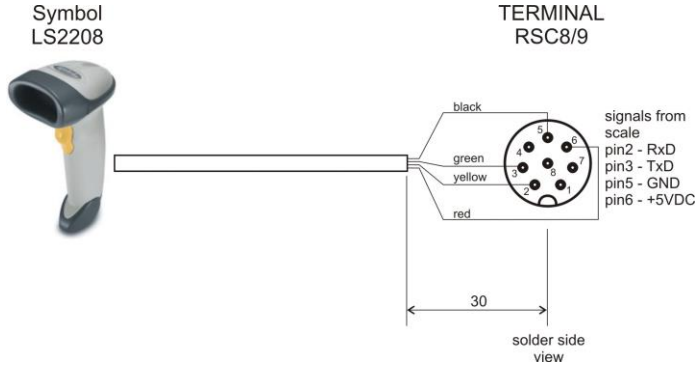

Indicator – barcode scanner cable (LS2208)

NOTE !!!
For STOP button use "NC" type contact.

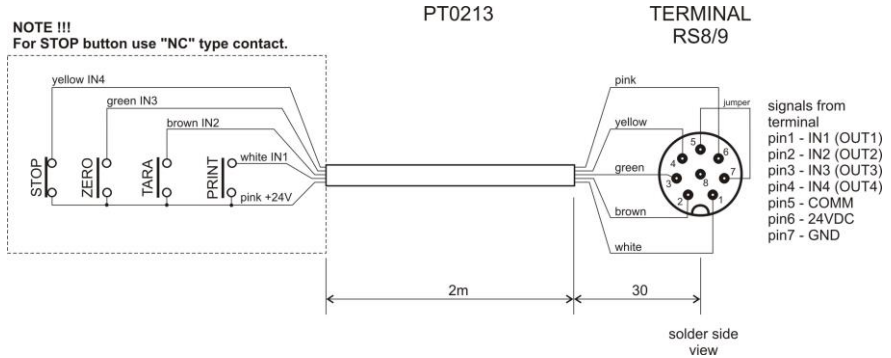

Indicator – PRINT, TARE, ZERO, STOP cable

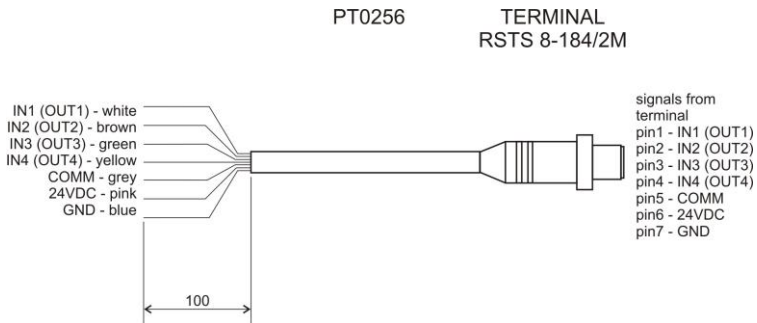

Indicator - IN/OUT cable



„Scale-Ethernet” cable is a standard network cable terminated with RJ45 connectors on both ends.



RADWAG BALANCES AND SCALES
ADVANCED WEIGHING TECHNOLOGIES

