



ITKB-16-01-12-21-EN

Quick Start

Weighing Platforms

- HRP High Resolution Platforms
- 1-Load-Cell Platforms
- 4-Load-Cell Platforms

To view the full user manual, go to the website or scan the QR code:



HRP

1. CONTENT

HRP High Resolution Platforms

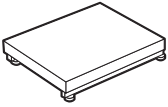

Platform
x1

F1 | C2-C3 | H1-H6 1-Load-Cell Platforms

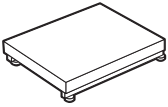

Platform
x1

D2 1-Load-Cell Platforms

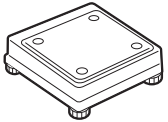

Scale
x1



Weighing pan
x1



Grounding foot x1



Foot
x3

4-Load-Cell Platforms

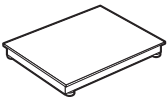

Platform
x1

Ramp Platforms

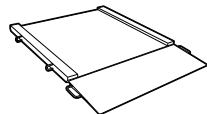

Platform x1
Ramp x1

2. UNPACKING

HRP Platforms, F1 | C2-C3 | H1-H6 1-Load-Cell Platforms

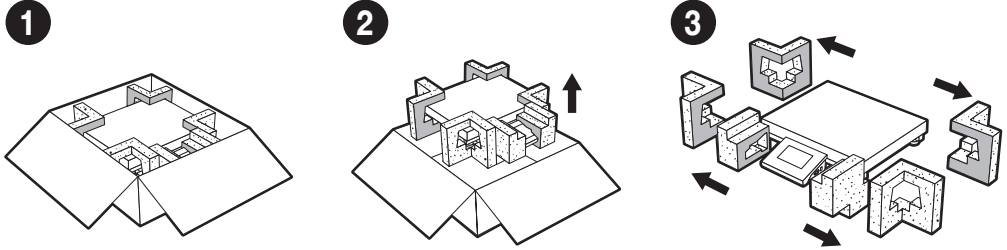

D2 1-Load-Cell Platforms

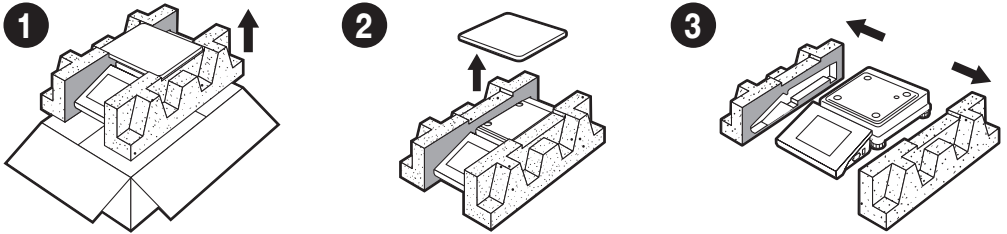

3. NOTES AND WARNINGS

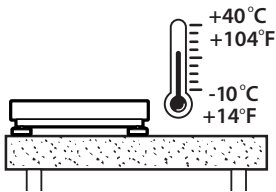

Operate the device in a room free from dust, where the temperature ranges: -10–40 °C (14–104 °F). Potential temperature change shall occur gradually and slowly.

Place the scale on a stable surface. For the most stable and repeatable results, it is recommended to use an anti-vibration table.

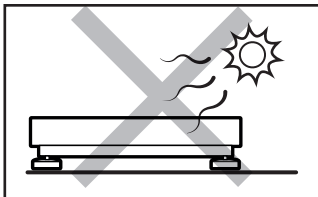

Place the scale away from heat sources. Avoid exposing the scale to the sunlight.

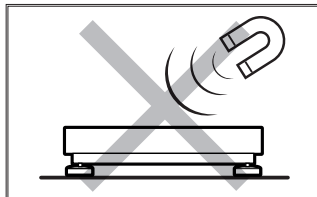

Avoid exposing the scale to the influence of a magnetic field. Do not weigh magnetic substances.

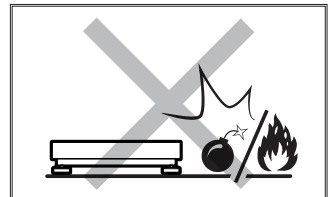

Not intended for use within EX zones. Not intended for weighing explosive or flammable substances.

4. PRE-OPERATION ACTIVITIES

4.1. Transport Lock Removal

HRP High Resolution Platforms

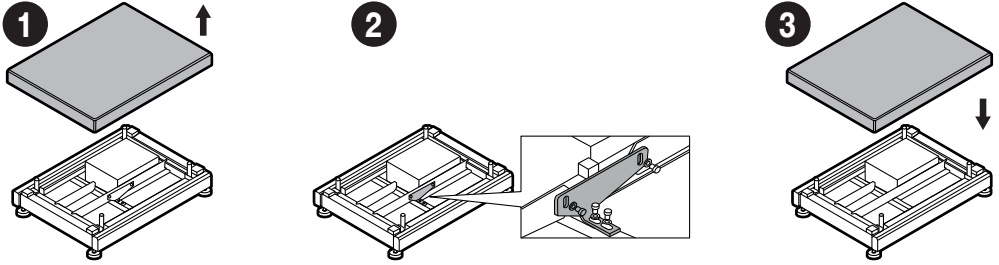

F1 | C2-C3 | H1-H6 1-Load-Cell Platforms

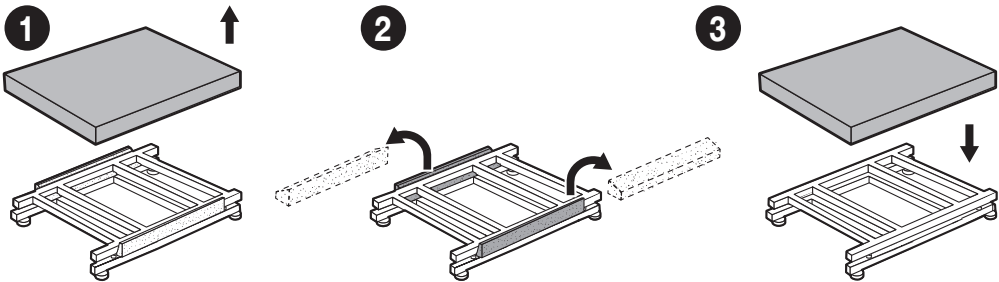

4-Load-Cell Platforms

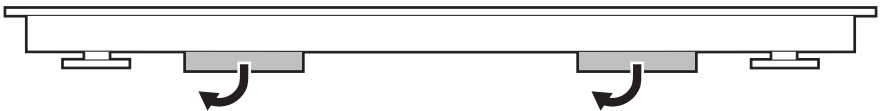

4.2. Grounding Check

Models: HRP

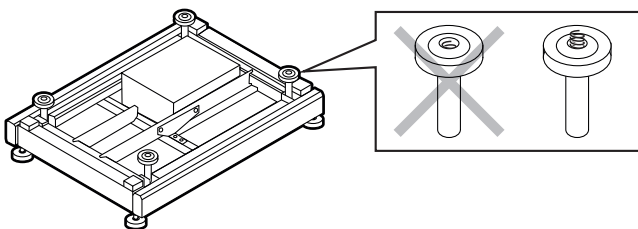

Check if the grounding spring is correctly positioned.

Make sure that the grounding spring protrudes slightly from the hole.

Models: F1 | G2-C3 | H1-H6 1-Load-Cell Platforms

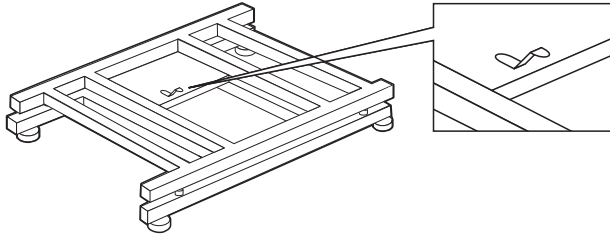

Check if the grounding plate is correctly positioned.

Make sure that the grounding plate extends above the platform.

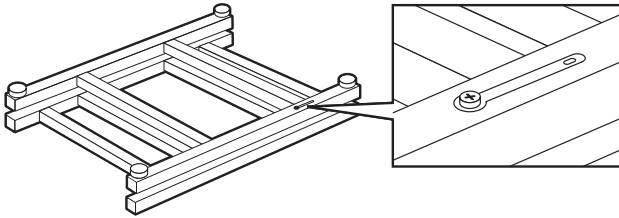

Check if the grounding plate is screwed on securely.

Attach the grounded copper wire to the plate.

Models: D2 1-Load-Cell Platforms

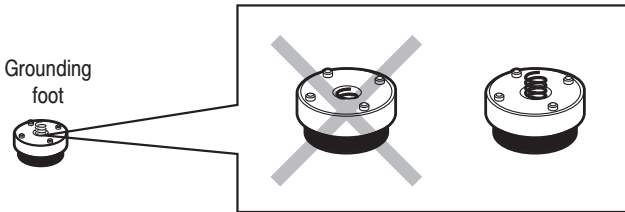

Check if the grounding spring is correctly positioned.

Make sure that the grounding spring protrudes slightly from the hole.

5. PLATFORM COMPONENTS ASSEMBLY

5.1. Platform Assembly

Models: HRP Platforms

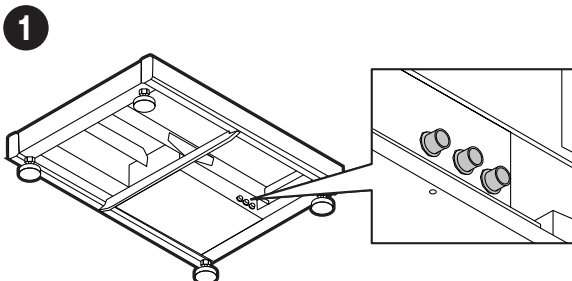

1 Connect the platform to the terminal via a suitable cable.

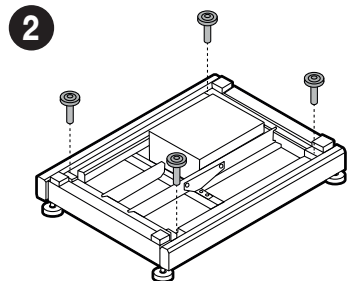

2 Insert weighing pan receivers into lever seats. Install the receiver with the grounding spring in the seat of your choice.

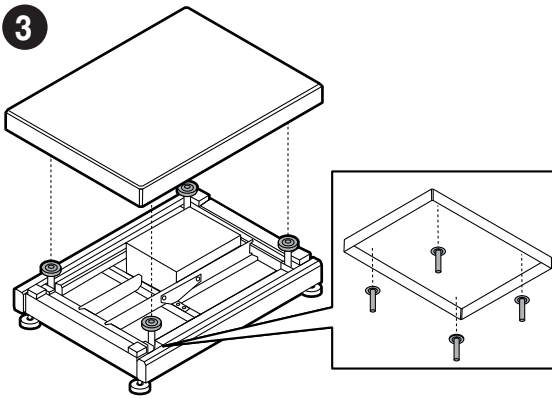

Install the weighing pan.

Models: D2 1-Load-Cell Platforms

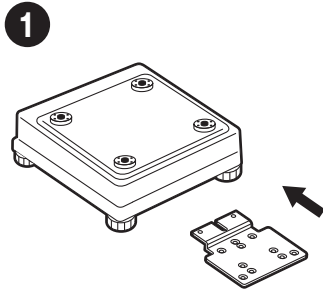

Install the bracket for the weighing terminal.

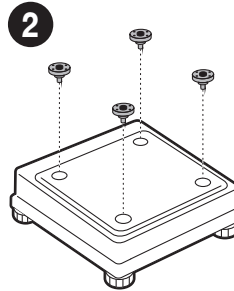

Install the grounding foot in the seat of your choice.

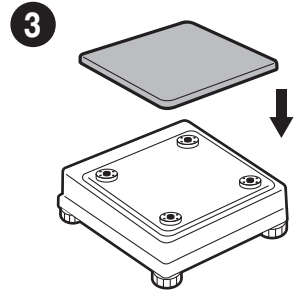

Install the weighing pan.

5.2. Feet Assembly (If Not Assembled)

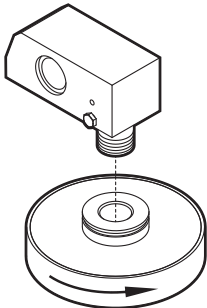

Screw the base of the foot onto the foot pin.

5.3. Ramp Scales - Floor Fixing

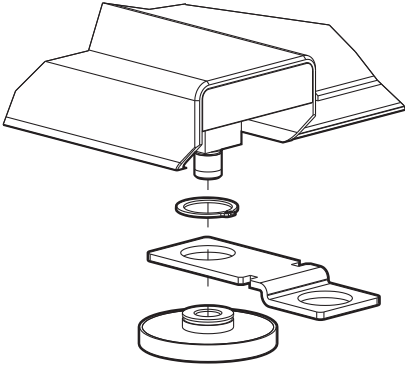

Attach the steel clamping rings to the scale feet and secure the whole thing with a steel locking ring. Attach the feet to the scale.

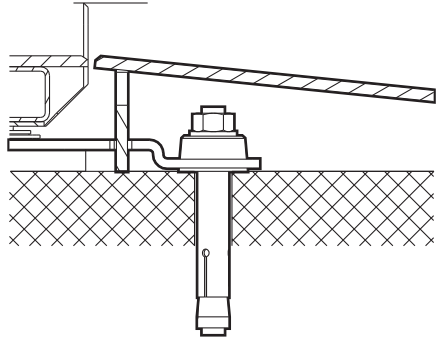

Fix the steel clamping rings to the floor and install the ramp.

5.4. Post Assembly (Scale Base)

Models: F1 | C2-C3 1-Load-Cell Platforms

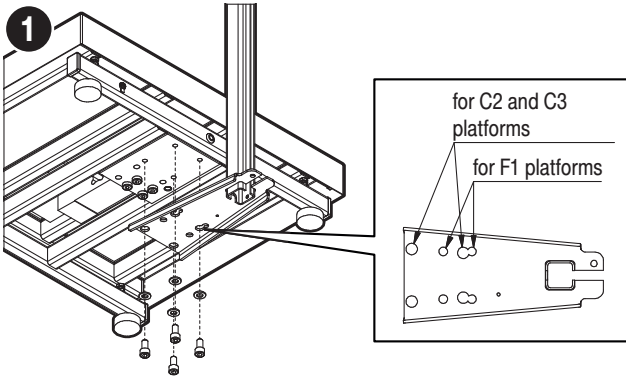

Screw the post to the scale base.

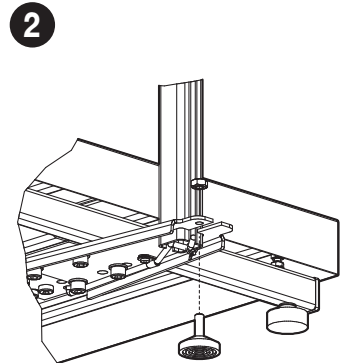

Screw the support under the post.

Models: H1-H6 1-Load-Cell Platforms

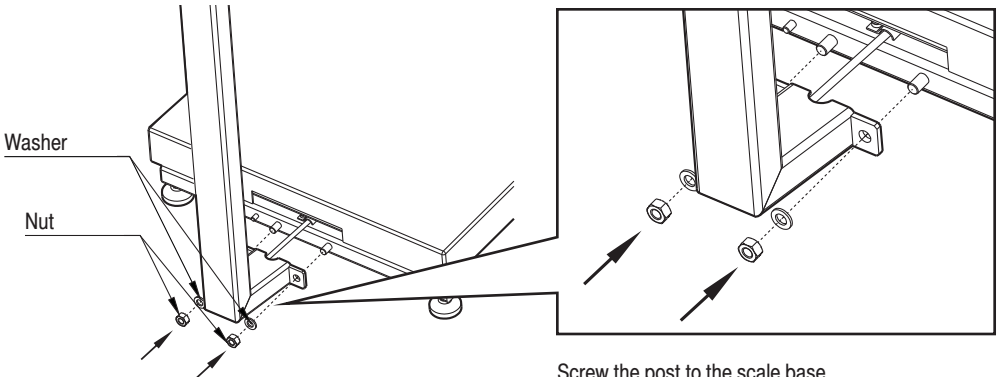

Screw the post to the scale base.

6. PLATFORM PREPARATION FOR WORK



Place the device on the workstation and leave it until it reaches ambient temperature.

6.1. Platform Temperature Stabilization

1



up to 1-8 h

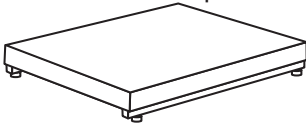

Prior to switching the platform on, let it reach room temperature (estimated stabilization time: 8 hours).

2

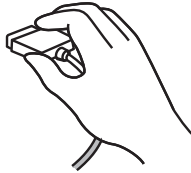

Connect the platform to the terminal via a suitable cable or communication interface.

6.2. LEVELLING

HRP High Resolution Platforms

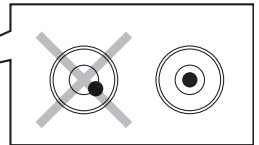
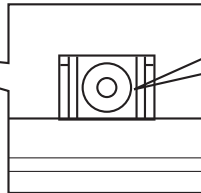
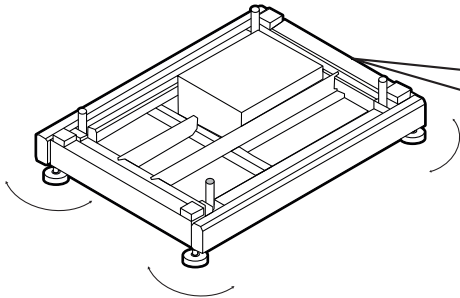

To level the scale, turn its feet; keep turning the feet until an air bubble takes the central position.

F1 | C2-C3 | H1-H6 1-Load-Cell Platforms

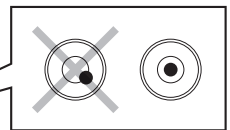
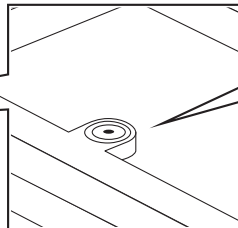
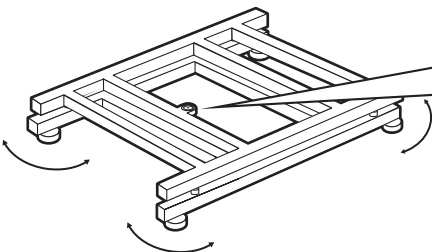

To level the scale, turn its feet; keep turning the feet until an air bubble takes the central position.

Models: D2 1-Load-Cell Platforms

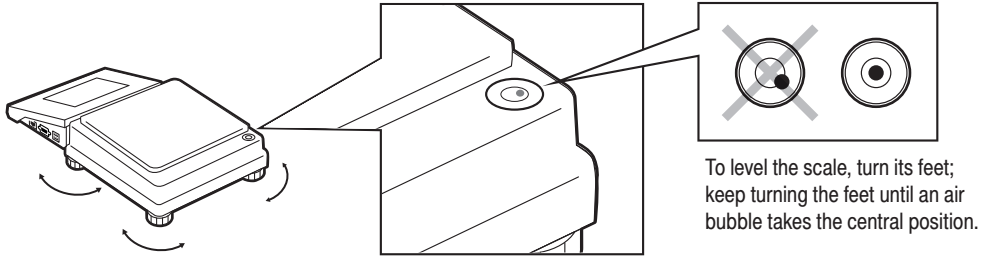

4-Load-Cell Platforms

 Have a spirit level ready to level the scale.

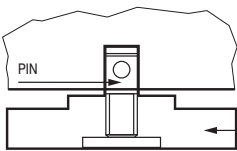
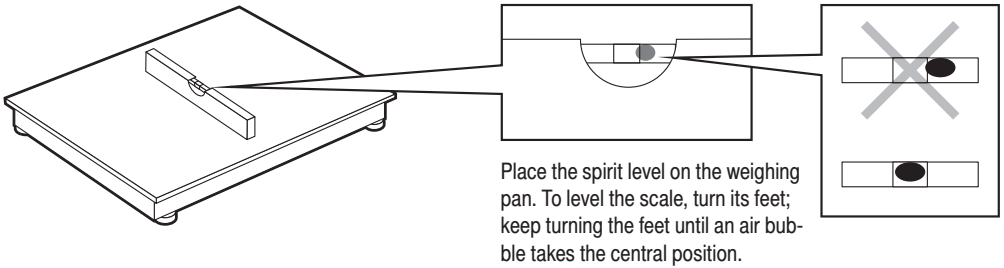

FOOT
BASE

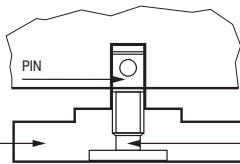

Adjustment span of the scale level is narrow, therefore the correct level is obtained using steel washers which are to be put under the feet.



Your platform is ready for operation!

7. CLEANING AND MAINTENANCE

7.1. Preparing for Cleaning

Switch the scale off. Unplug the scale from the mains. Remove elements that are not part of the scale.

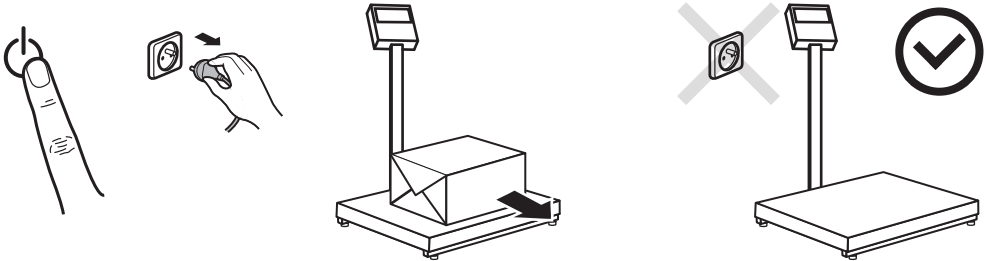

7.2. Preliminary Cleaning

Remove stuck-on large impurities, residues of the weighed product. Do not use sharp, metal tools.

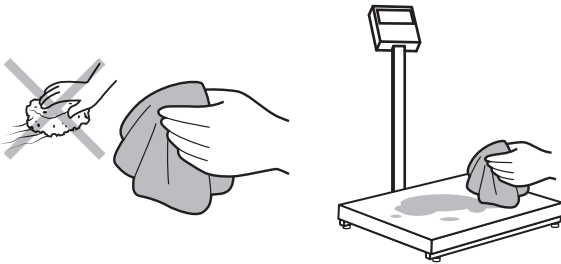

7.3. Terminal Cleaning

Clean the keyboard and the display. Clean the housing cavities and cable entries.

Thoroughly remove detergents. It is recommended to cover the terminal before further cleaning.

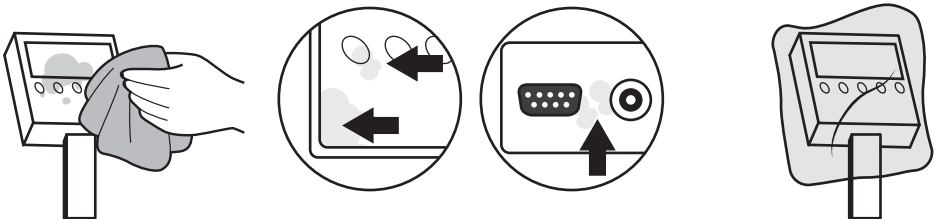

7.4. Weighing Pan Cleaning

The weighing pan is usually the most soiled. Clean it thoroughly. Lift, disassemble and wash underneath if possible.

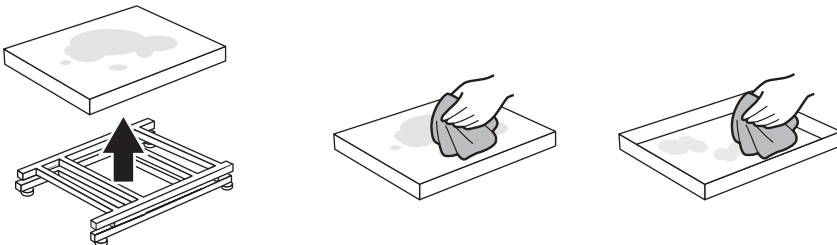

7.5. Platform Structure Cleaning

Lift the weighing pan if possible. Wash the structure. Clean the dirt in the corners and recesses of the structure. Clean the accessories: ramps – lift and wash underneath if possible.

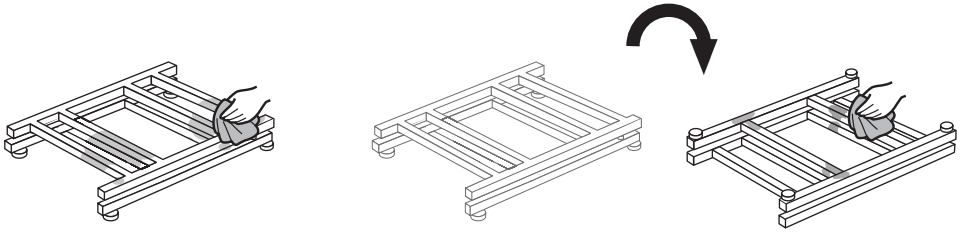

7.6. Feet and Floor Cleaning

Wash the platform feet and the floor underneath the platform.

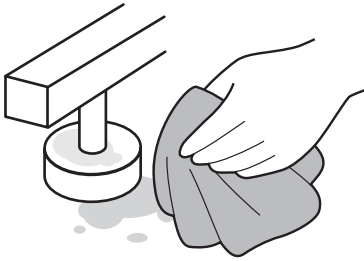

7.7. Removing Detergents

Thoroughly remove detergents from the weighing pan, platform structure, feet and floor.

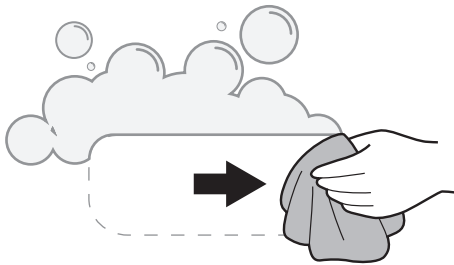

7.8. Platform Levelling

Place the weighing platform on a dry floor. Check the levelling. Adjust the level of the weighing platform if necessary. Install the weighing pan if removed. Connect to the mains when completely dry.

Clean and disinfect all surfaces immediately after the weighing process.

