

HX5.EX

EX SCALES

USER MANUAL

ITKU-101-02-12-18-EN













 **RADWAG BALANCES AND SCALES**
ADVANCED WEIGHING TECHNOLOGIES

DECEMBER 2018

PRECAUTIONS

Prior installation, use or maintenance activities, carefully read this User Manual. Use the HX5 EX-* scale only as intended. This user manual must be at a reach of the operator's hand in the course of device operation.

	Symbol marking sections that are extremely important for protection against explosion.
	The device must be applied in accordance with the intended use only.
	Prior installation and start, it is necessary to analyse whether the device complies with the usage requirements regarding particular hazardous area.
	In case of any sign of damage, it is necessary to disconnect the device from the mains immediately. The damaged component must be replaced or repaired by RADWAG service immediately.
	While installing the device, it is necessary to follow strictly this user manual requirements. Not adhering to the requirements results with loss of explosion safety.
	The HX5.EX-* scale can be connected only to certified intrinsically safe instruments characterised with respective intrinsic safety parameters provided further down this user manual. Connection method must be accordant with this user manual requirements. Connecting other than intrinsically safe or certified device, results with loss of explosion safety of the complete set.
	The HX5.EX-* scales may be used as a component of device/set intended for operation in hazardous area. Manufacturer of such device/set is obliged to carry out analysis of the complete device/set in order to confirm compliance with standards.
	The device must be connected to the grounding permanently.
	It is not allowed to use the device in places, where mechanisms causing electrostatic charges greater than those caused by rubbing the surface by hand, occur.
	Do not apply protection shields.
	Technical condition of the scale must be tested and inspected by a trained personnel, in accordance with this user manual, at least once every three months.

CONTENTS

1. INTENDED USE	6
2. USAGE CONDITIONS	7
2.1. Supplying the PUE HX5.EX-* Indicator with Power	7
2.2. Electrostatic Charges Hazard.....	7
2.3. Device with Permanently Fixed Wires	7
3. WARRANTY CONDITIONS	7
4. SAFETY REQUIREMENTS	8
4.1. ATEX Markings – Symbols Meaning	9
4.2. Data Plates	10
4.3. Information Stickers Arrangement	11
5. TECHNICAL CONDITION INSPECTION	12
6. MAINTENANCE ACTIVITIES	12
7. SERVICE AND REPAIR	13
8. UTILISATION	13
9. HX5.EX-* SCALES DESIGN	13
9.1. HX5.EX-* Scales Symbols	14
9.2. HX5.EX-* One Load Cell Scales	16
9.2.1. Design of HX5.EX-* One Load Cell Scale	16
9.2.2. HX5.EX-* One Load Cell Scales Classification	17
9.3. HX5.EX-* Multiple Load Cell Scales.....	19
9.3.1. Design of HX5.EX-* Multiple Load Cell Scale	19
9.3.2. HX5.EX-* Multifunctional Load Cell Scales Classification	20
9.4. HX5.EX-* Scales with Load Cell Modules	24
9.4.1. Design of Scale with Load Cell Modules.....	24
9.4.2. Classification of HX5.EX-* Scales with Load Cell Modules	25
10. PUE HX5.EX-* WEIGHING INDICATOR	25
10.1. Main Components.....	26
10.2. Overall Indicator Dimensions	27
10.3. Operation Panel.....	27
10.4. Technical Specifications.....	29
10.5. Models	29
10.6. Connectors Arrangement	29
10.6.1. RS232, RS485 Connectors	30
10.6.1.1. Pins Assignment	30
10.6.1.2. Intrinsic Safety Parameters	31
10.7. Digital Inputs and Outputs.....	31
10.7.1. In/Out Cables Marking.....	32
10.7.2. Intrinsic Safety Parameters for IN/OUT Circuits	33
10.7.3. Technical Specifications for IN/OUT.....	33
10.8. Permissible Inputs/Outputs Configuration	34
10.8.1. Active Inputs	34
10.8.2. Passive Inputs in Ex Zone	34
10.8.3. Passive Inputs Outside Ex Zone	35
10.8.4. Active Outputs.....	37
10.8.5. Passive Outputs in Ex Zone	37
10.8.6. Passive Outputs Outside Ex Zone.....	38
11. HX5.EX-* SCALES INSTALLATION	39
11.1. Unpacking.....	40
11.2. Preparing for Operation.....	40
11.2.1. Workstation	41
11.2.2. Installation at the Workstation	41
11.2.3. Levelling	42
11.2.4. Checking Metal Components Resistance	42
11.2.4.1. One Load Cell Scales	42
11.2.4.2. Multiple Load Cell Scales.....	43
11.2.5. Grounding	43
11.3. Connecting Power Supply.....	45

12. HX5.EX-* SCALE START-UP	47
13. HOME SCREEN.....	47
13.1. Top Bar.....	47
13.2. Weighing Result Window.....	48
13.3. Workspace.....	48
13.4. Pictograms.....	48
14. OPERATING THE MENU	49
14.1. Entering the Menu.....	49
14.2. Menu Keys.....	49
14.3. Entering Numeric and Text Characters and Signs	50
14.4. Return to the Weighing Mode	50
15. GOOD WEIGHING PRACTICE	51
16. CONNECTION CABLES LIST	53
17. ERROR MESSAGES	53
18. STANDARDS LIST	54

1. INTENDED USE

HX5.EX-* scales are intended to carry out fast and precise mass measurements. Due to use of a multifunctional PUE HX5.EX-* indicator, the scales are a perfect solution for numerous industry applications. The scales are designed in accordance with Directive 2014/34/EU and IECEx Certification requirements, and, depending on the design, they can be used in environment filled with explosive gases and dust, classified as zones: 1, 2, 21, 22.

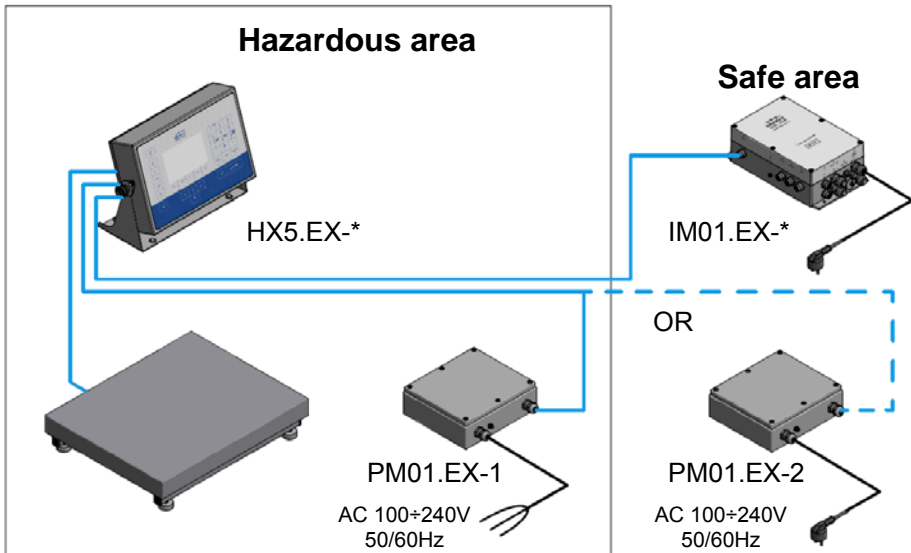

 **Not all the models are intended for operation in dust atmospheres. Detailed list of scales and their protection level is to be found further down this user manual.**

The standard version of the scale is equipped with the following communication interfaces enabling cooperation with devices placed in the hazardous area: 2 x RS232, RS485, and digital 4IN/4OUT (optionally). The scales can be connected to the mains only via an intrinsically safe power supply, PM01.EX-1 or PM01.EX-2. To the PUE .EX-* indicator, a IM01.EX-* communication module, placed outside the hazardous area, can be connected. Due to its intrinsically safe interface, the IM01.EX-* module can expand the indicator's interfaces range: Ethernet, 2 x RS232, RS485, digital 12IN/12OUT, USB, analog outputs, PROFIBUS.

HX5.EX-* scales are devices intended to be permanently fixed at the workstation. It is forbidden to use the scale in the course of relocation.

2. USAGE CONDITIONS

2.1. Supplying the PUE HX5.EX-* Indicator with Power

The PUE HX5.EX-* indicator must be powered using either PM01.EX-1 or PM01.EX-2 power supply, both of them manufactured by RADWAG WAGI ELEKTRONICZNE Witold Lewandowski, Radom, EU-type examination certificate KDB 17ATEX0066X and IECEx OBAC 19.0001X certificate.

2.2. Electrostatic Charges Hazard

In order to minimize electrostatic charges hazard it is necessary to:

- make sure that the device is permanently grounded in the course of operation,
- follow cleaning-relevant recommendations that are to be found in section 6 of this user manual.

2.3. Device with Permanently Fixed Wires

	<i>It is forbidden to disconnect the wires that are permanently fixed to the device.</i>
---	---

3. WARRANTY CONDITIONS



- A. RADWAG feels obliged to repair or exchange all elements that appear to be faulty by production or by construction.
- B. Defining defects of unclear origin and means of their elimination can only be realized with assistance of manufacturer and user representatives.
- C. RADWAG does not bear any responsibility for damage or losses resulting from misuse, or unauthorized use or servicing.
- D. The warranty does not cover:
 - mechanical damage caused by product exploitation other than intended, damage of thermal and chemical origin, damage caused by lightning, overvoltage in the power network or other random event,
 - inappropriate cleaning habits.
- E. Loss of warranty takes place if:
 - a repair is carried out outside RADWAG authorized service point,
 - service claims intrusion into mechanical or electronic construction by unauthorized people,
 - the scale does not bear security seal stickers.
- F. For detailed warranty conditions read the warranty certificate.
- G. Contact with the central authorized service: +48 (48) 386 63 30.

4. SAFETY REQUIREMENTS

Prior the first use, carefully read this User Manual. Use the weighing device only as intended.

Depending on the model, the HX5.EX-* scales can be used in:

- zones 1 and 2 where there is a risk of explosion due to mixture of air with vapour, mist or gas, classified as explosion group IIC, IIB and IIA and as temperature class T1, T2, T3, T4,
- zones 21 and 22 where there is a risk of explosion due to mixture of air with dust, flammable fibres and volatile fuels, classified as explosion group IIIC, IIIB and IIIA.

	<i>Not all the models are intended for operation in dust atmospheres. Detailed list of scales and their protection level is to be found further down this user manual.</i>
	<i>All instruments connected to scale's digital IN/OUT and connectors, require 'ia' or 'ib' protection.</i>

Explosion safety of HX5.EX-* scale is ensured by:

- Intrinsically safe design of the HX5.EX-* scale, adhering to regulations of EN 60079-0 and EN 60079-11.
- EU-type examination certificate, UE KDB 17ATEX0066X, and IECEx OBAC 19.0001X certificate.
- Use of certified RADWAG-manufactured intrinsically safe power supplies (exclusively):
 - PM01.EX-1 power supply intended for operation in zone where there is an explosion risk, zones: 1, 2, 21 and 22.
 - PM01.EX-2 power supply intended for operation in safe area, equipped with intrinsically safe circuits which may be placed in zones 1, 2, 21 and 22.
- Use of load cell(s) certified for conformity with Directive 2014/34/EU IECEx Certification requirements, intended (depending on platform type) for operation in hazardous area 1, 2 or in zones 1, 2, 21 and 22, with intrinsically safe "ia" or "ib" level of protection, and meeting requirements for group II, category 1 or 2.
- Not exposing the scale to static electricity. Functional grounding cables which level the potentials must always be connected to the marked terminals. Disconnecting the functional grounding cables is forbidden. Disconnecting potentials equalizing cable (e.g. when there is a need to place the device elsewhere) is allowed only if there is no risk of explosive atmosphere.
- **Adhering to this user manual guidelines.**

4.1. ATEX Markings – Symbols Meaning



II 2 G Ex ib IIC T4 Gb

Equipment group:
 I - to be used in mines where there's risk of mine gas explosion
 II - to be used in places where there's risk of explosion of gases other than mine gases

Types of group II devices:
 1 - equipment providing very high protection level,
 - for operation in zone 0,1,2
 2 - equipment providing high protection level,
 - for operation in zone 1,2
 3 - equipment providing standard protection level,
 - for operation in zone 2

Explosive atmosphere:
 G - caused by mixture of air with vapour, mist or gas
 D - caused by mixture of air with dust

Electrical equipment corresponding with one or several anti-explosion mechanical designs

Symbol of used explosion proof mechanical design, e.g.:
 mb - hermetic, for operation in zone 1,2,
 tb – protection via housing for operation in zones 1,2,
 e - increased safety
 ia - intrinsically safe design for operation in zone 0,1,2,
 ib - intrinsically safe design for operation in zone 1,2.

Gas explosion group, examples:
 - IIA: propane (T1) benzene (T3) butane (T2) ethanol (T2)
 - IIB: ethylene (T2)
 - IIC: acetylene (T2) hydrogen (T1)
 or dust, examples:
 - IIIA: volatile fuels
 - IIIB: non-conductive dust
 - IIIC: conductive dust

Max surface temperature:
 - for gases it is specified as temperature class determining max surface temperature of device components that are in touch with explosive mixture:
 T1: 450 °C
 T2: 300 °C
 T3: 200 °C
 T4: 135 °C
 T5: 100 °C
 T6: 85 °C
 - for dusts it is specified as max measured surface temp, e.g.:
 T60°C

Protection class gas atmosphere:
 - Ga
 - Gb
 - Gc
 dust atmosphere:
 - Da
 - Db
 - Dc

4.2. Data Plates

Data plates of HX5.EX-* scales:



1	Manufacturer's logo.
2	Manufacturer's name and address.
3	Scale type.
4	Serial no.
5	Metrological scale's parameters.
6	Metrological approvals numbers*.
7	Geographically relevant data, i.e.: gravitational acceleration, or latitude and altitude*.
8	Accuracy class*.
9	WEEE symbol.
10	CE mark + M* + year* + notified body no. (NAWI directive)*.
11	Ex mark: gases (read section 4.1).
12	Ex mark: dusts (read section 4.1).

13	Numbers of ATEX and IECEx certificates of the scale with „X” symbol - special conditions of use.
14	Power supply.
15	Ambient temperature.
16	IP ingress protection.
17	CE mark + notified body no.
18	Warning against danger with regard to electrostatic charges, written in Polish, English, German, other.
* - for verified scales exclusively.	

4.3. Information Stickers Arrangement

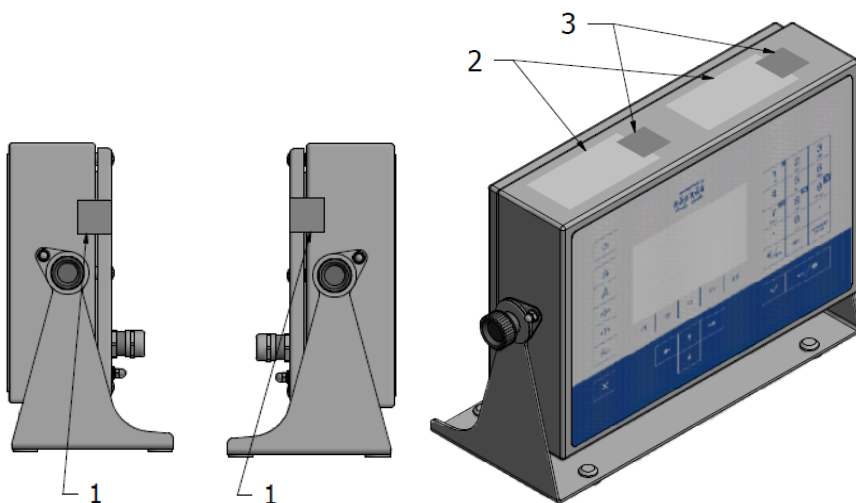

Arrangement of data plates and security stickers

1 - cover's security seals

2 - data plates

3 - data plates' security seals (in case of data plates of void seal type, the security seals are not used)



Data plates are attached to all detachable components that influence intrinsic safety of the complete device.

5. TECHNICAL CONDITION INSPECTION





	<p><i>The technical condition of the HX5.EX-* scale operated in the hazardous area must be tested and inspected by a trained personnel (familiar with this user manual content) at least once every three months.</i></p>
---	--

In the course of inspection check:

- Functional grounding state of the indicator and the platform:
 - cable-housing connection,
 - connection resistance – Max. 100 Ω.
- Indicator keypad state – cuts, holes, detachment from the housing impermissible.
- Cable glands – loose wires impermissible:
 - gland-housing and connector-housing torque – 10 Nm,
 - gland's cup nut torque – 5 Nm.
- Hole plugs state - any unused connectors and ports must be covered.
- Security stickers state and data plates state – they must be complete (not broken/damaged etc.). Either damage or lack of security stickers or data plates is impermissible, this results with loss of warranty and makes the manufacturer no longer responsible for the device safety.
- Indicator cover –make sure it is closed.
 - cover screws torque – 0.5 Nm.

6. MAINTENANCE ACTIVITIES

Prior maintenance it is necessary to disconnect the scale from the mains, and to check grounding connection and state. You can clean the device using regular household cleaners.

	<p><i>Clean the scale when there is no risk of occurrence of explosive atmosphere.</i></p>
	<p><i>Clean the scale using a wet cloth. It is especially important if the scale is operated in a room where there is dry air. Moisture protects against accumulation of electrostatic charges.</i></p>
	<p><i>Avoid using abrasive cleaners while cleaning the indicator's housing, do not use concentrated acids, bases, solvents or alcohol.</i></p>
	<p><i>It is not allowed to clean the scale using compressed air.</i></p>

7. SERVICE AND REPAIR

	<p><i>In case of any sign of damage, it is necessary to disconnect the device from the mains immediately. The damaged component must be replaced or repaired by RADWAG service immediately.</i></p>
---	--

In case of any problems with correct operation of the scale, contact the closest manufacturer's service point.

In case of defects, deliver the faulty product to the manufacturer's service point. If the product cannot be delivered to the manufacturer's service point, call the service and report the defect. Repair scope and method will be set up.

	<p><i>The user is NOT ALLOWED to carry out any kind of repair of the device himself/herself. Any attempt of scale modification, repair etc., by unauthorized persons, will result with loss of validity of manufacturer-issued certificates, declarations and warranty.</i></p>
---	--

8. UTILISATION

HX5.EX-* scales should be recycled, they are not to be treated as a regular household waste. Indicators to be decommissioned must be decommissioned in accordance with valid legal regulations.



9. HX5.EX-* SCALES DESIGN

HX5.EX-* scales are comprised of two basic units: a platform with one or many load cells, and a PUE HX5.EX-* indicator displaying the weighing result.

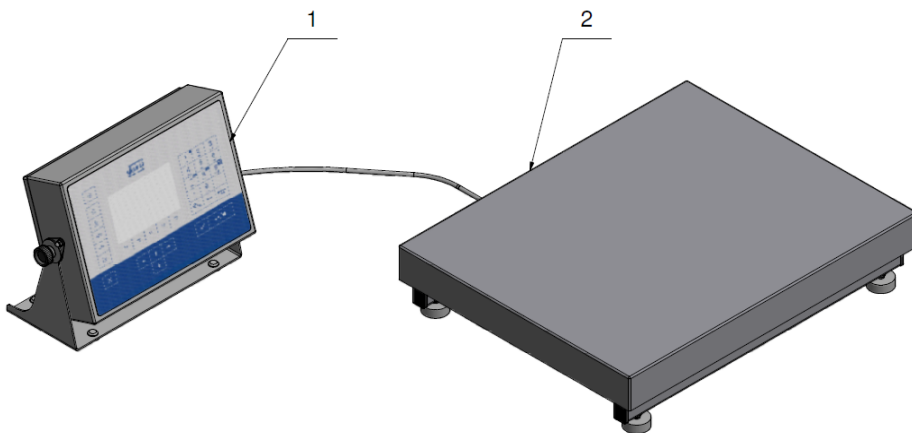

Scale design, the main components
 1- PUE HX5.EX-* weighing indicator,
 2- platform.

Depending on used weighing platform the scales are divided into three product groups: scales equipped with one load cell, scales equipped with many load cells, scales equipped with load cell modules.

9.1. HX5.EX-* Scales Symbols

HX5.EX-tt.vv.xx.zz

HX5.EX – indicator model,

- – spacer (dash),

tt – indicator type,

. – spacer (dot),

vv – load cells quantity, platform model (not applicable in case of one load cell scales),

. – spacer (dot),

xx – platform capacity (in case of dual range scales the values are separated by '/' sign),

. – spacer (dot),

zz – platform type and size, customized design.

HX5.EX-tt.vv.xx.zz

└─ **one load cell** platform model and type:

C.. – one load cell, model: **PL.C**

exemplary type: C1, C2, C3, C..., CQ

F.. – one load cell, model: **PL.F**

exemplary type: F1, F..., FQ

H.. – one load cell, model: **PL.H**

exemplary type: H1, H2, H3, H4, H5, H..., HQ

HB.. – one load cell, model: **PL.HB**

exemplary type: HB2, HB3, HB4, HB..., HBQ

HR.. – one load cell, model: **PL.HR**

exemplary type: HR2, HR3, HR4, HR..., HRQ

OR

multiple load cell platform type

(model specified in „load cells quantity” position)

C.. – four load cell, model: **PL.4.C**

exemplary type: C6, C7, C8, C8/9, C..., CQ

H.. – four load cell, model: **PL.4.H**

exemplary type: H6, H7, H8, H8/9, H..., HQ

H..Z – four load cell, model: **PL.4.H.Z**

exemplary type: H6/Z, H7/Z, H8/Z, H../Z, HQ/Z

H..ZD – four load cell, model: **PL.4.H.ZD**

exemplary type: H6/ZD, H7/ZD, H../ZD, HQ/ZD

H.. – four load cell, model: **PL.4N.H**

exemplary type: H1, H2, H3, H4, H..., HQ

C.. – four load cell, model: **PL.4P.C**

exemplary type: C, CQ

H.. – four load cell, model: **PL.4P.H**

exemplary type: H, HQ

C.. – four load cell, model: **PL.4P2.C**

exemplary type: C, C1, C2, C..., CQ

H.. – four load cell, model: **PL.4P2.H**

exemplary type: H, H1, H2, H..., HQ

MT.. – multiple load cell, model: **PL.4P2.H**

exemplary type: H, H1, H2, H..., HQ

└─ Platform capacity in kg:

single range e.g.: 150 – stands for Max 150kg

dual range e.g.: 60/150 – stands for Max 60/150kg

└─ quantity of load cells in platform:

none – position not applicable in case of one load cell platforms

4 – four load cell platforms, model: PL.4.C, PL.4.H, PL.4.H.Z

4N – four load cell platforms, model: PL.4N.H

4P – four load cell platforms, model: PL.4P.C, PL.4P.H

4P2 – four load cell platforms, model: PL.4P2.C, PL.4P2.H

3...8 – preferable quantity within 3-8 range, model: PL.MT.C,

PL.MT.H

└─ indicator type:

e.g.: 1, 2, ...

9.2. HX5.EX-* One Load Cell Scales

HX5.EX-* one load cell scales are intended to carry out fast and precise mass measurements of loads up to 300 kg. When it comes to design of one load cell scales, its characteristic feature is platform equipped with one load cell only. The platforms are equipped with a stainless steel weighing pan. Depending on scale model, the cross and base are made either of stainless steel or powder-coated steel.

9.2.1. Design of HX5.EX-* One Load Cell Scale

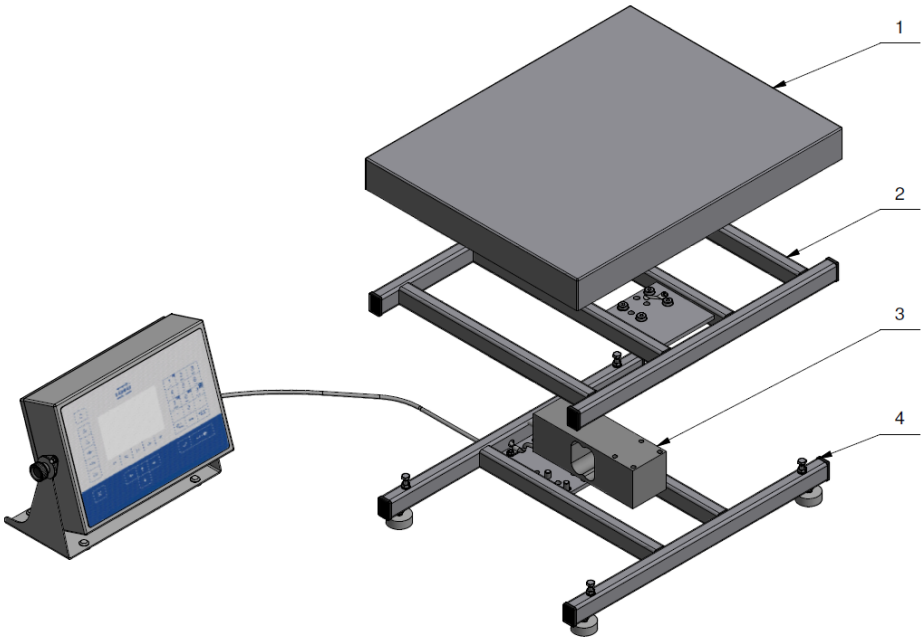

*One load cell scale design, the main components
1-weighing pan,
2-cross,
3-load cell,
4-base.*

9.2.2. HX5.EX-* One Load Cell Scales Classification

Depending on the platform design, the one load cell scales of HX5.EX-* series have been classified as follows.

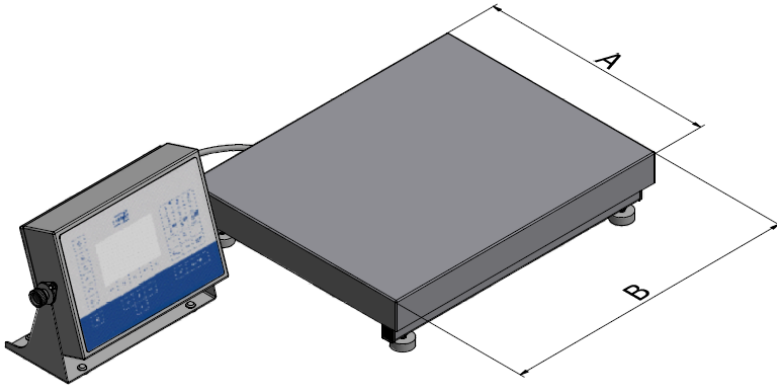

Scale model	Platform model	Platform type	Weighing pan dimensions AxB	Platform material
HX5.EX-tt.xx.C2	PL.C	C2	400x500	Coated steel
HX5.EX-tt.xx.C3		C3	500x700	
HX5.EX-tt.xx.CQ		CQ	150÷800x150÷800	
HX5.EX-tt.xx.F1	PL.F	F1	300x300	Coated steel
HX5.EX-tt.xx.FQ		FQ	150÷800x150÷800	
HX5.EX-tt.xx.H1	PL.H	H1	150x200	AISI 304 stainless steel
HX5.EX-tt.xx.H2		H2	250x300	
HX5.EX-tt.xx.H3		H3	410x410	
HX5.EX-tt.xx.H3/5		H3/5	400x600	
HX5.EX-tt.xx.H4		H4	500x500	
HX5.EX-tt.xx.H5		H5	600x600	
HX5.EX-tt.xx.HQ		HQ	150÷800x150÷800	
HX5.EX-tt.xx.HB2	PL.HB	HB2	250x300	AISI 304 stainless steel
HX5.EX-tt.xx.HB3		HB3	410x410	
HX5.EX-tt.xx.HB3/5		HB3/5	400x600	
HX5.EX-tt.xx.HB4		HB4	500x500	
HX5.EX-tt.xx.HB5		HB5	600x600	
HX5.EX-tt.xx.HB6		HB6	800x800	
HX5.EX-tt.xx.HBQ		HBQ	150÷800x150÷800	
HX5.EX-tt.xx.HR2	PL.HR	HR2	250x300	AISI 316 stainless steel
HX5.EX-tt.xx.HR3		HR3	410x410	
HX5.EX-tt.xx.HR3/5		HR3/5	400x600	
HX5.EX-tt.xx.HR4		HR4	500x500	
HX5.EX-tt.xx.HR5		HR5	600x600	
HX5.EX-tt.xx.HRQ		HRQ	150÷800x150÷800	
tt – indicator type xx – scale capacity				



One load cell scale's weighing pan dimensions

Platform type determines whether particular scale can be operated in a given hazardous area or not. The below table presents list of zones where a particular scale can be used.

Scale model	Platform model	Zone		Ex marking
		Gases	Dusts	
HX5.EX-tt.xx.C2	PL.C	1, 2	-	Ex II 2G Ex ib IIB T4 Gb
HX5.EX-tt.xx.C3				
HX5.EX-tt.xx.CQ				
HX5.EX-tt.xx.F1	PL.F	1, 2	-	Ex II 2G Ex ib IIB T4 Gb
HX5.EX-tt.xx.FQ				
HX5.EX-tt.xx.H1	PL.H	1, 2	-	Ex II 2G Ex ib IIB T4 Gb
HX5.EX-tt.xx.H2				
HX5.EX-tt.xx.H3				
HX5.EX-tt.xx.H3/5				
HX5.EX-tt.xx.H4				
HX5.EX-tt.xx.H5				
HX5.EX-tt.xx.HQ				
HX5.EX-tt.xx.HB2	PL.HB	1, 2	21, 22	Ex II 2G Ex ib IIC T4 Gb Ex II 2D Ex ib IIIC T60 ⁰ C...T135 ⁰ C* Db
HX5.EX-tt.xx.HB3				
HX5.EX-tt.xx.HB3/5				
HX5.EX-tt.xx.HB4				
HX5.EX-tt.xx.HB5				
HX5.EX-tt.xx.HB6				
HX5.EX-tt.xx.HBQ				

HX5.EX-tt.xx.HR2	PL.HR	1, 2	21, 22	 II 2G Ex ib IIC T4 Gb  II 2D Ex ib IIIC T60°C...T135°C* Db
HX5.EX-tt.xx.HR3				
HX5.EX-tt.xx.HR3/5				
HX5.EX-tt.xx.HR4				
HX5.EX-tt.xx.HR5				
HX5.EX-tt.xx.HRQ				
tt – indicator type xx – scale capacity *) – conditioned by used load cells				

9.3. HX5.EX-* Multiple Load Cell Scales

HX5.EX-* multiple load cell scales are intended to carry out fast and precise mass measurements of large loads. When it comes to design of multiple load cell scales, its characteristic feature is platform equipped with numerous load cells, usually four. The platforms, depending on the scale type, are made of stainless steel or powder-coated steel. Their design is customized with reference to intended use (pallet scales, beam scales, ramp scales, etc.).

9.3.1. Design of HX5.EX-* Multiple Load Cell Scale

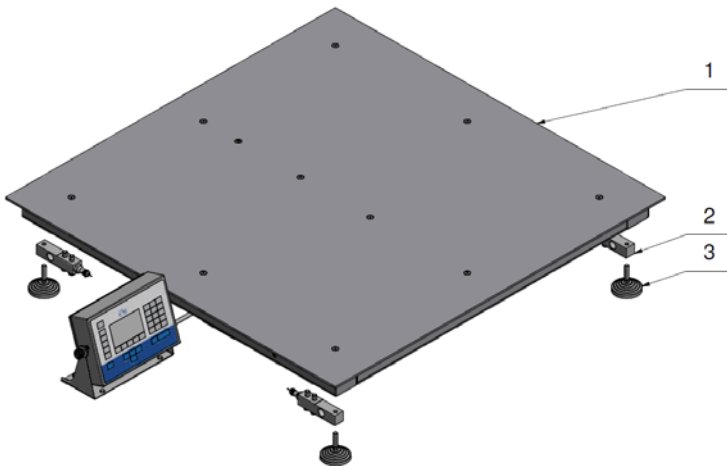

Multiple load cell scale design, the main components

- 1- weighing pan,
- 2- load cells,
- 3- feet.

9.3.2. HX5.EX-* Multifunctional Load Cell Scales Classification

Depending on the platform design, the multifunctional load cell scales of HX5.EX-* series have been classified as follows.

Scale model	Platform model	Platform type	Weighing pan dimensions AxB	Platform material
HX5.EX-tt.4.xx.C6	PL.4.C	C6	800x800	Coated steel
HX5.EX-tt.4.xx.C7		C7	1000x1000	
HX5.EX-tt.4.xx.C7/8.1		C7/8.1	1000x1250	
HX5.EX-tt.4.xx.C8		C8	1200x1200	
HX5.EX-tt.4.xx.C8/9		C8/9	1200x1500	
HX5.EX-tt.4.xx.C8.1		C8.1	1250x1250	
HX5.EX-tt.4.xx.C8.1/9		C8.1/9	1250x1500	
HX5.EX-tt.4.xx.C9		C9	1500x1500	
HX5.EX-tt.4.xx.C10		C10	1500x2000	
HX5.EX-tt.4.xx.C11		C11	2000x2000	
HX5.EX-tt.4.xx.CQ		CQ	300÷4000x300÷4000	
HX5.EX-tt.4.xx.H6	PL.4.H	H6	800x800	AISI 304 stainless steel
HX5.EX-tt.4.xx.H7		H7	1000x1000	
HX5.EX-tt.4.xx.H8		H8	1200x1200	
HX5.EX-tt.4.xx.H8/9		H8/9	1200x1500	
HX5.EX-tt.4.xx.H9		H9	1500x1500	
HX5.EX-tt.4.xx.H10		H10	1500x2000	
HX5.EX-tt.4.xx.H11		H11	2000x2000	
HX5.EX-tt.4.xx.HQ		HQ	300÷4000x300÷4000	
HX5.EX-tt.4.xx.H6/Z	PL.4.H.Z	H6/Z	800x800	AISI 304 stainless steel
HX5.EX-tt.4.xx.H7/Z		H7/Z	1000x1000	
HX5.EX-tt.4.xx.H8/Z		H8/Z	1200x1200	
HX5.EX-tt.4.xx.H8/9/Z		H8/9/Z	1200x1500	
HX5.EX-tt.4.xx.H9/Z		H9/Z	1500x1500	
HX5.EX-tt.4.xx.H10/Z		H10/Z	1500x2000	
HX5.EX-tt.4.xx.H11/Z		H11/Z	2000x2000	
HX5.EX-tt.4.xx.HQ/Z		HQ/Z	300÷4000x300÷4000	

HX5.EX-tt.4.xx.H6/ZD	PL.4.H.ZD	H6/ZD	800x800	AISI 304 stainless steel
HX5.EX-tt.4.xx.H7/ZD		H7/ZD	1000x1000	
HX5.EX-tt.4.xx.H8/ZD		H8/ZD	1200x1200	
HX5.EX-tt.4.xx.H8/9/ZD		H8/9/ZD	1200x1500	
HX5.EX-tt.4.xx.H9/ZD		H9/ZD	1500x1500	
HX5.EX-tt.4.xx.H10/Z		H10/ZD	1500x2000	
HX5.EX-tt.4.xx.H11/Z		H11/ZD	2000x2000	
HX5.EX-tt.4.xx.HQ/Z		HQ/ZD	300÷4000x300÷4000	
HX5.EX-tt.4N.xx.H1	PL.4N.H	H1	840x860	AISI 304 stainless steel
HX5.EX-tt.4N.xx.H2		H2	1100x1200	
HX5.EX-tt.4N.xx.H3		H3	1200x1500	
HX5.EX-tt.4N.xx.H4		H4	1500x1500	
HX5.EX-tt.4N.xx.HQ		HQ	350÷2000x350÷2000	
HX5.EX-tt.4P.xx.C	PL.4P.C	C	840x1200	Coated steel
HX5.EX-tt.4P.xx.CQ		CQ	600÷2000x600÷2000	
HX5.EX-tt.4P.xx.H	PL.4P.H	H	840x1200	AISI 304 stainless steel
HX5.EX-tt.4P.xx.HQ		HQ	600÷2000x600÷2000	
HX5.EX-tt.4P2.xx.C	PL.4P2.C	C	2 pcs. 120x1200	Coated steel
HX5.EX-tt.4P2.xx.C1		C1	2 pcs. 120x2000	
HX5.EX-tt.4P2.xx.C2		C2	2 pcs. 120x2500	
HX5.EX-tt.4P2.xx.CQ		CQ	2 pcs. 80÷200x600÷3000	
HX5.EX-tt.4P2.xx.H	PL.4P2.C	H	2 pcs. 120x1200	AISI 304 stainless steel
HX5.EX-tt.4P2.xx.H1		H1	2 pcs. 120x2000	
HX5.EX-tt.4P2.xx.H2		H2	2 pcs. 120x2500	
HX5.EX-tt.4P2.xx.HQ		HQ	2 pcs. 80÷200x600÷3000	
tt – indicator type xx – scale capacity				

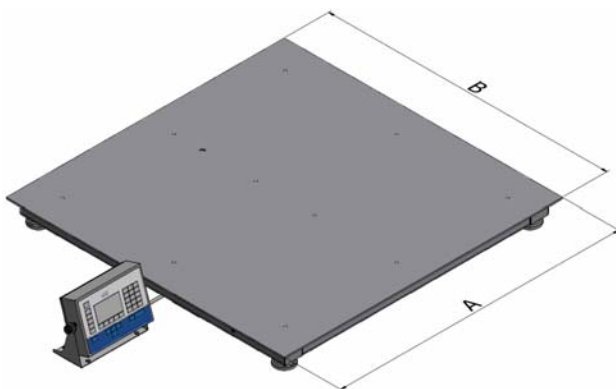



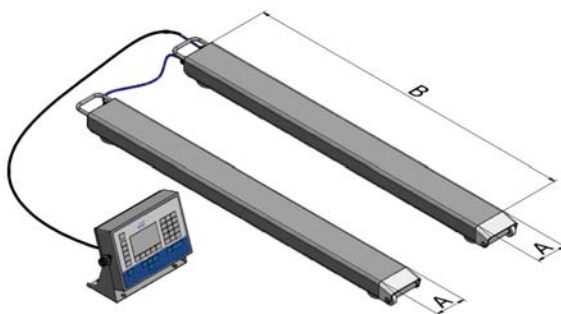





Multiple load cell scale's weighing pan dimensions





Multiple load cell scale's weighing pan dimensions, PL.4P2.H platform

Platform type determines whether particular scale can be operated in a given hazardous area or not. The below table presents list of zones where a particular scale can be used.

Scale model	Platform model	Zone		Ex marking
		Gases	Dusts	
HX5.EX-tt.4.xx.H6	PL.4.H	1, 2	21, 22	⚠ II 2G Ex ib IIC T4 Gb ⚠ II 2D Ex ib IIIC T60°C...T135°C* Db
HX5.EX-tt.4.xx.H7				
HX5.EX-tt.4.xx.H8				
HX5.EX-tt.4.xx.H8/9				
HX5.EX-tt.4.xx.H9				
HX5.EX-tt.4.xx.H10				
HX5.EX-tt.4.xx.H11				
HX5.EX-tt.4.xx.HQ				

HX5.EX-tt.4.xx.H6/Z	PL.4.H.Z	1, 2	-	 II 2G Ex ib IIB T4 Gb
HX5.EX-tt.4.xx.H7/Z				
HX5.EX-tt.4.xx.H8/Z				
HX5.EX-tt.4.xx.H8/9/Z				
HX5.EX-tt.4.xx.H9/Z				
HX5.EX-tt.4.xx.H10/Z				
HX5.EX-tt.4.xx.H11/Z				
HX5.EX-tt.4.xx.HQ/Z				
HX5.EX-tt.4.xx.H6/ZD	PL.4.H.ZD	1, 2	21, 22	 II 2G Ex ib IIC T4 Gb  II 2D Ex ib IIIC T60°C...T135°C* Db
HX5.EX-tt.4.xx.H7/ZD				
HX5.EX-tt.4.xx.H8/ZD				
HX5.EX-tt.4.xx.H8/9/ZD				
HX5.EX-tt.4.xx.H9/ZD				
HX5.EX-tt.4.xx.H10/Z				
HX5.EX-tt.4.xx.H11/Z				
HX5.EX-tt.4.xx.HQ/Z				
HX5.EX-tt.4.xx.C6	PL.4.C	1, 2	-	 II 2G Ex ib IIB T4 Gb
HX5.EX-tt.4.xx.C7				
HX5.EX-tt.4.xx.C7/8.1				
HX5.EX-tt.4.xx.C8				
HX5.EX-tt.4.xx.C8/9				
HX5.EX-tt.4.xx.C8.1				
HX5.EX-tt.4.xx.C8.1/9				
HX5.EX-tt.4.xx.C9				
HX5.EX-tt.4.xx.C10				
HX5.EX-tt.4.xx.C11				
HX5.EX-tt.4.xx.CQ				
HX5.EX-tt.4P.xx.C	PL.4P.C	1, 2	-	 II 2G Ex ib IIB T4 Gb
HX5.EX-tt.4P.xx.CQ				
HX5.EX-tt.4P.xx.H	PL.4P.H	1, 2	21, 22	 II 2G Ex ib IIC T4 Gb  II 2D Ex ib IIIC T60°C...T135°C* Db
HX5.EX-tt.4P.xx.HQ				
HX5.EX-tt.4P2.xx.C	PL.4P2.C	1, 2	-	 II 2G Ex ib IIB T4 Gb
HX5.EX-tt.4P2.xx.C1				
HX5.EX-tt.4P2.xx.C2				
HX5.EX-tt.4P2.xx.CQ				

HX5.EX-tt.4P2.xx.H	PL.4P2.H	1, 2	21, 22	<div style="display: flex; justify-content: space-between;"> <div style="text-align: left;">  II 2G  II 2D T60⁰C...T135⁰C* Db </div> <div style="text-align: right;"> Ex ib IIC T4 Gb Ex ib IIIC </div> </div>
HX5.EX-tt.4P2.xx.H1				
HX5.EX-tt.4P2.xx.H2				
HX5.EX-tt.4P2.xx.HQ				
tt – indicator type xx – scale capacity *) – conditioned by used load cells				

9.4. HX5.EX-* Scales with Load Cell Modules

HX5.EX-* scales with load cell modules are intended to carry out mass measurement of silos. Modules are built into construction of fixed to the ground silo's support. In most cases, the scales design includes 3-4 load cell modules. The modules, depending on the type, are made of stainless or galvanized steel.

9.4.1. Design of Scale with Load Cell Modules

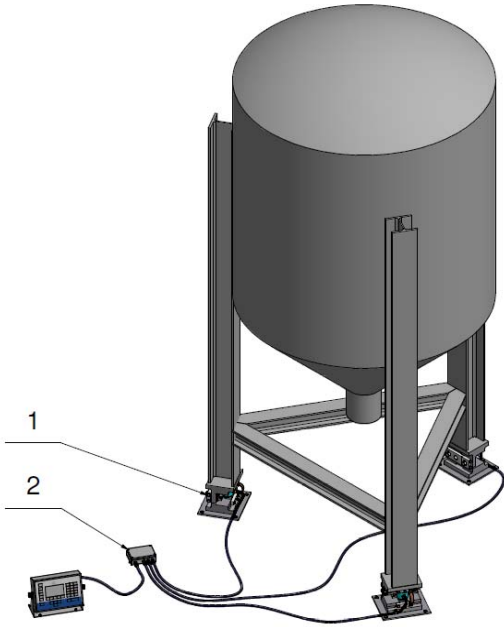

Scale design, the main components
 1- Module,
 2- junction box.

9.4.2. Classification of HX5.EX-* Scales with Load Cell Modules

Depending on the design, the HX5.EX-* scales with load cell modules have been classified as follows.

Scale model	Modules set model	Module type	Module material
HX5.EX-tt.vv.xx.MTC1	PL.MT.C	C1	Stainless or galvanised steel
HX5.EX-tt.vv.xx.MTC2		C2	
HX5.EX-tt.vv.xx.MTH1	PL.MT.H	H1	Stainless steel
HX5.EX-tt.vv.xx.MTH2		H2	
tt – indicator type vv – load cells quantity xx – scale capacity			

Module type determines whether particular scale can be operated in a given hazardous area or not. The below table presents list of zones where a particular scale can be used.

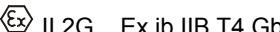
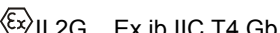
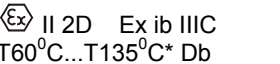
Scale model	Modules set model	Zone		Ex marking
		Gases	Dusts	
HX5.EX-tt.vv.xx.MTC1	PL.4P.C	1, 2	-	
HX5.EX-tt.vv.xx.MTC2				
HX5.EX-tt.vv.xx.MTH1	PL.4P.H	1, 2	21, 22	 
HX5.EX-tt.vv.xx.MTH2				
tt – indicator type vv – load cells quantity xx – scale capacity *) – conditioned by used load cells				

10. PUE HX5.EX-* WEIGHING INDICATOR

The PUE HX5.EX-* indicator is equipped with stainless steel housing, ensuring high IP rating, and 5" display, offering excellent readability. It is operated using 33-key membrane keypad equipped with programmable function keys. The housing features bracket which facilitates fixing the indicator to a wall, or placing it on a table. The bracket enables you to customize the inclination angle to your needs and preferences.

10.1. Main Components

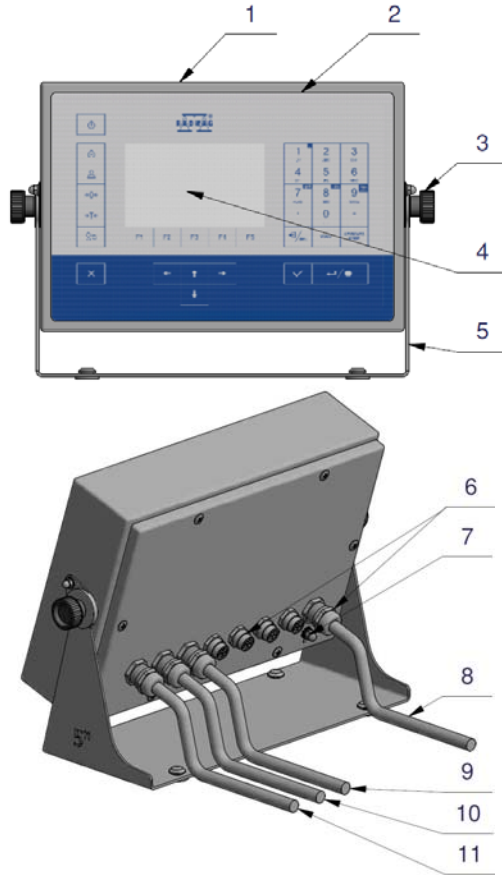

Main Components

1	Stainless steel housing.
2	Membrane keypad.
3	Knobs – inclination angle regulation.
4	Display.
5	Bracket.
6	Cable glands and connectors.
7	Grounding terminal.
8	Power cord.
9	Inputs cable.

10	Outputs cable.
11	Weighing platform cable.

10.2. Overall Indicator Dimensions

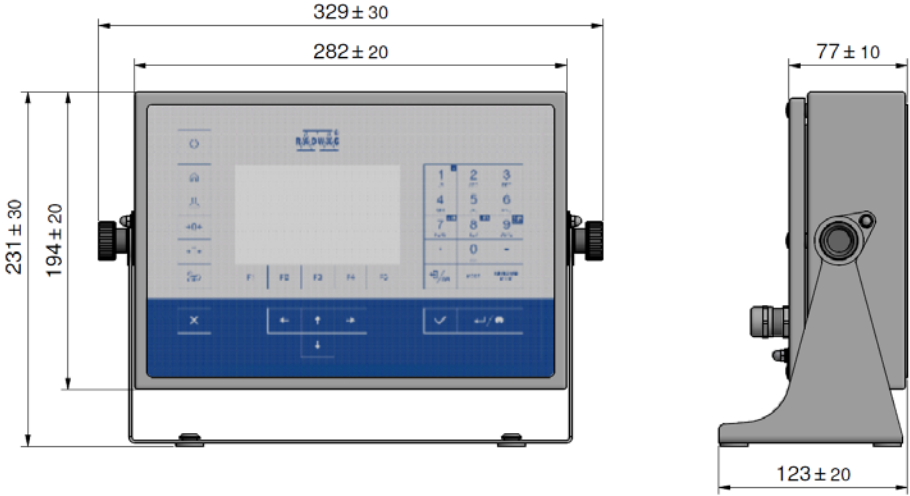





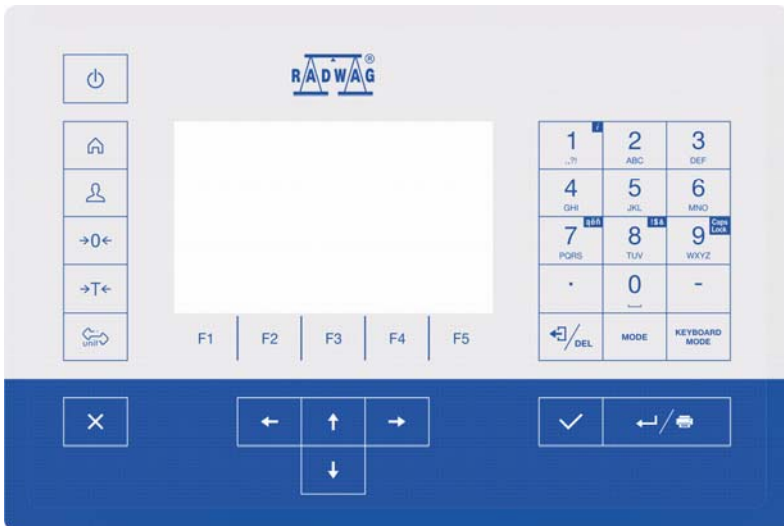











Overall Indicator Dimensions

10.3. Operation Panel



Keys:

	Press to switch the indicator on / off.
	Press to enter the main menu.
	Press to log in.
	Press to zero the scale.
	Press to tare the scale.
	Press to change the weighing unit.
	Press to cancel the message.
	Press to confirm the message.
	Press to change the working mode.
	Press to confirm the weighing result (PRINT). Press to confirm the messages (ENTER).
	Press to cancel the messages.
	Programmable key assigned to a pictogram displayed in the bottom screen area.
	Programmable key assigned to a pictogram displayed in the bottom screen area.
	Programmable key assigned to a pictogram displayed in the bottom screen area.
	Programmable key assigned to a pictogram displayed in the bottom screen area.
	Programmable key assigned to a pictogram displayed in the bottom screen area.

10.4. Technical Specifications

	PUE HX5.EX-*
Housing	Stainless steel
IP ingress protection by EN 60529	IP66/IP68
Display	5" colour widescreen Resolution 800x480
Keypad	Numeric + function keys
Power supply	From an intrinsically safe RADWAG-manufactured PM01.EX-* power supply
Ambient temperature	-10°C ÷ 40°C
Relative humidity	10÷85% RH, non-condensing conditions
Maximum number of connected platforms	1

10.5. Models

There are 4 different models:



PUE HX5.EX-1: standard design,

PUE HX5.EX-2: standard design + digital 4IN/4OUT,

PUE HX5.EX-3: standard design + digital 4IN,

PUE HX5.EX-4: standard design + digital 4OUT.

10.6. Connectors Arrangement

	<i>Since the indicator is intended for operation in hazardous area, its communication interfaces have been equipped with hermetic intrinsically safe connectors.</i>
	<i>Unused connectors and ports must be covered with hole plugs.</i>
	<i>The PUE HX5.EX-* indicator can be connected only to intrinsically safe devices that are enumerated in this user manual, or to certified instruments characterised with respective intrinsically safe parameters. Connection method must be accordant with this user manual requirements. Connecting other than intrinsically safe or certified device, results with loss of explosion safety of the complete set.</i>

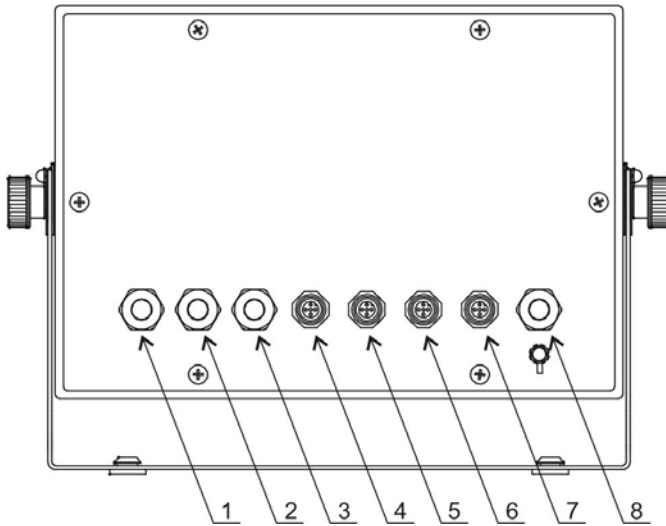



PUE HX5.EX- indicator connectors:*

- 1 – PLATFORM: cable gland for weighing platform,
- 2 – OUT: cable gland for outputs,
- 3 – IN: cable gland for inputs,
- 4 – RS232 (1): RS232 (1) connector,
- 5 – RS232 (2): RS232 (2) connector,
- 6 – RS485: RS485 connector,
- 7 – IM01.EX: communication module connector,
- 8 – PM01.EX: cable gland for intrinsically safe power supply.

10.6.1. RS232, RS485 Connectors

	<p>All instruments connected to scale's RS232, RS485 connectors require 'ia' or 'ib' protection.</p>
---	---

10.6.1.1. Pins Assignment

	<p>Pin2 – RxD Pin3 – TxD Pin5 – GND</p>	<p>RS232 (COM1, COM2) M12 5P</p>
	<p>Pin1 - A Pin3 - B</p>	<p>RS485 M12 4P</p>

10.6.1.2. Intrinsic Safety Parameters



RS232 interface, connectors marked as RS232 (1), RS232 (2):	
Uo	23.6V ($\pm 11.8V$)
Io	81mA
Po	0.51W
Co	100nF
Lo	0.5mH
Li	negligibly small
Ci	negligibly small
Ui	24.2V ($\pm 12.1V$)
Ii	40mA
Pi	any value
RS485 interface, connectors marked as RS485, IM01.EX:	
Uo	5.88V
Io	55mA
Po	81mW
Co	1.7 μ F
Lo	5mH
Li	negligibly small
Ci	negligibly small
Ui	6V
Ii	65mA

10.7. Digital Inputs and Outputs

PUE HX5.EX-* indicator optionally features 4 digital galvanically isolated inputs and 4 digital galvanically isolated outputs. Inputs and outputs are fed through separate cables via cable glands. On inputs and outputs connectors there is common power and ground for active inputs and/or outputs.

Inputs and outputs cables' insulation is removed at a length of about 150mm, cable wires are terminated with tubular end sleeves.

	<p><i>It is forbidden to connect electric potential and ground of internal power supply unit (Uo and GND on IN/OUT interfaces terminals of the indicator) with an external intrinsically safe power supply. This would result with loss of intrinsic safety.</i></p>
---	---

	<p><i>Under the threat of loss of intrinsic safety, the user must connect the supplied cables to the junction box of his/her electrical system. The connection must be done in accordance with Ex standard guidelines, and good engineering practice.</i></p>
	<p><i>All instruments connected to scale's digital IN/OUT require 'ia' or 'ib' protection.</i></p>

Suggested solutions, EX versions:

GL503.T-C9615,

GL703.T-C9620,

manufactured by Pepperl-Fuchs, or other models of likewise parameters.

10.7.1. In/Out Cables Marking

INPUTS		OUTPUTS	
WIRE NO.	SIGNAL	WIRE NO.	SIGNAL
1	I1-	1	O1B
2	I1+	2	O1A
3	I2-	3	O2B
4	I2+	4	O2A
5	I3-	5	O3B
6	I3+	6	O3A
7	I4-	7	O4B
8	I4+	8	O4A
9	Uo	9	Uo
10	GND	10	GND

<div style="border: 1px solid black; padding: 10px; margin: 10px auto; width: 80%;"> <p style="text-align: center;">PT0325-IN PUE HX5.EX - IN</p> <p style="text-align: center; margin-top: 20px;">PUE HX5.EX - IN PT0325-IN</p> <p style="text-align: center;">Inputs cable label</p> </div>	<div style="border: 1px solid black; padding: 10px; margin: 10px auto; width: 80%;"> <p style="text-align: center;">PT0325-OUT PUE HX5.EX - OUT</p> <p style="text-align: center; margin-top: 20px;">PUE HX5.EX - OUT PT0325-OUT</p> <p style="text-align: center;">Outputs cable label</p> </div>
--	---

10.7.2. Intrinsic Safety Parameters for IN/OUT Circuits

OUT cables pairs (outputs): 1-2, 3-4, 5-6, 7-8	
U _i	30V
I _i	any value
P _i	0.49W
L _i	negligibly small
C _i	negligibly small
IN cables pairs (inputs): 1-2, 3-4, 5-6, 7-8	
U _i	30V
I _i	any value
P _i	any value
L _i	negligibly small
C _i	negligibly small
9-10 OUT cable pair (outputs) and 9-10 IN cable pair (inputs). CIRCUITS CONNECTED IN PARALLEL	
U _o	13.65V
I _o	42mA
P _o	0.52W
Total C _o	0.49μF
Total L _o	0.5mH

10.7.3. Technical Specifications for IN/OUT

Inputs parameters	
Inputs quantity	4
Inputs type	Galvanically isolated
Cable cross-section	0.5 – 1mm ²
Outputs parameters	
Outputs quantity	4
Outputs type	Galvanically isolated
Cable cross-section	0.5 – 1mm ²

10.8. Permissible Inputs/Outputs Configuration

This section provides examples of inputs and outputs connections. For all the cases it is necessary to adhere to rules for matching external devices to indicator's inputs and outputs with regard to intrinsic safety parameters.

10.8.1. Active Inputs

Most frequently used configuration for operation in hazardous area. External buttons (relays contacts) are powered directly from the PUE HX5.EX-* indicator.

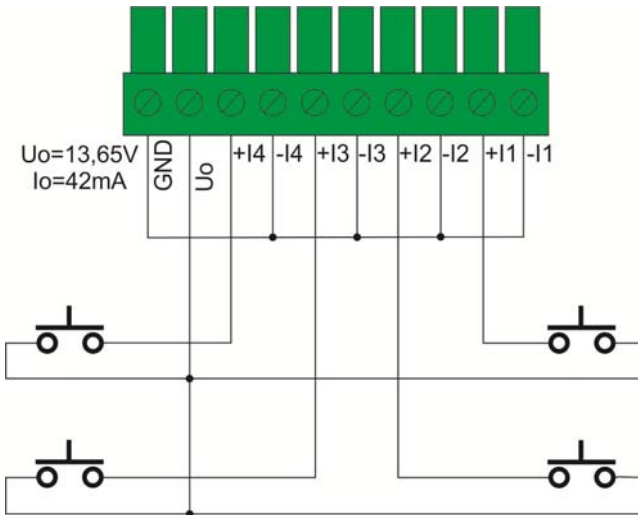

10.8.2. Passive Inputs in Ex Zone

Configuration intended to be used in hazardous area. External buttons (relay contacts) are powered using an external power supply.

The external power supply must be an intrinsically safe device characterized with features corresponding to the existing explosive atmosphere.

	<p><i>It is forbidden to connect electric potential and ground of internal power supply unit (U_o and GND on IN/OUT interfaces terminals of the indicator) with an external intrinsically safe power supply. This would result with loss of intrinsic safety.</i></p>
	<p><i>All instruments connected to scale's digital IN/OUT require 'ia' or 'ib' protection.</i></p>

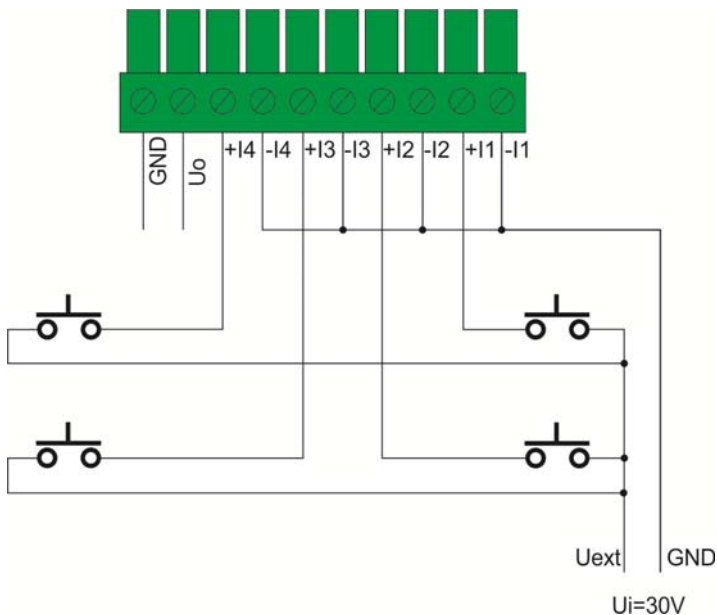

10.8.3. Passive Inputs Outside Ex Zone

Configuration intended to be used outside hazardous area. External buttons (relay contacts) are powered using an external power supply placed outside the hazardous area.

The power supply and the external buttons (relay contacts) are connected via relevant diode barriers.

	<p><i>It is forbidden to connect electric potential and ground of internal power supply unit (U_o and GND on IN/OUT interfaces terminals of the indicator) with an external power supply. This would result with loss of intrinsic safety.</i></p>
	<p><i>All instruments connected to scale's digital IN/OUT require 'ia' or 'ib' protection.</i></p>

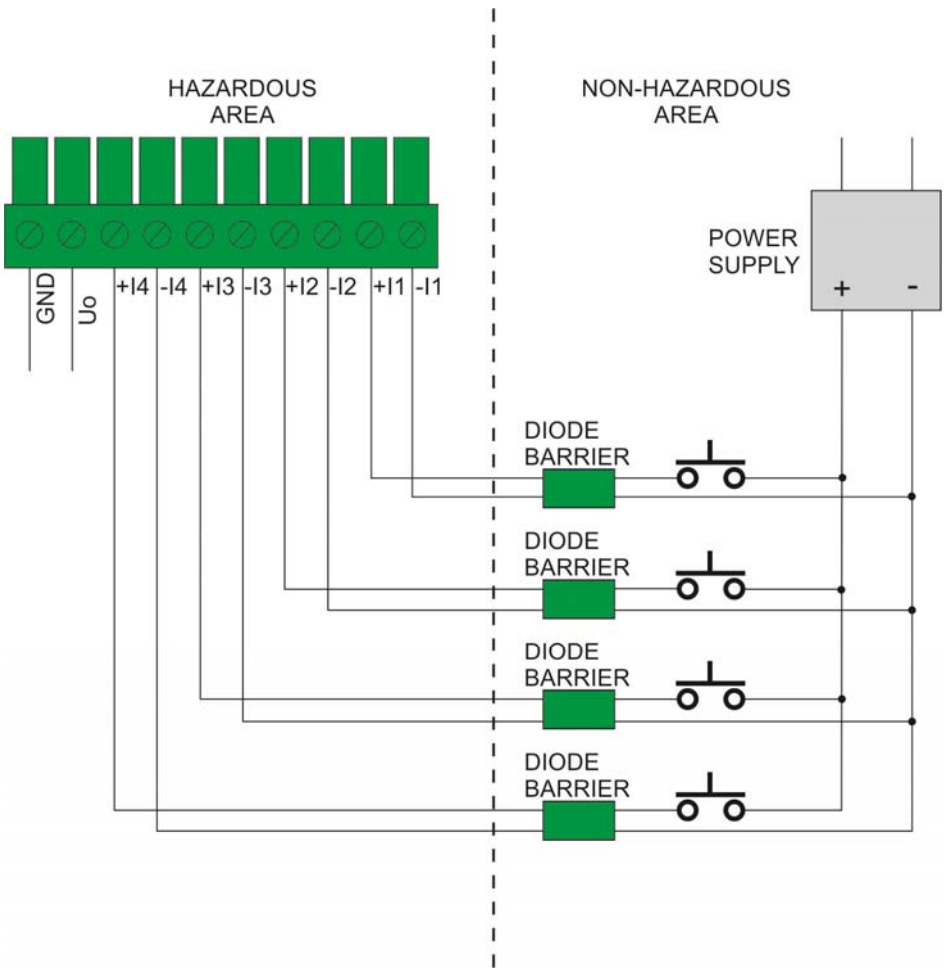

10.8.4. Active Outputs

Exemplary configuration intended to be used in hazardous area.

Outputs load (LOAD) is powered directly from the indicator. Maximum load of voltage source $U_0=13.65V$ cannot be greater than $I_0=42mA$ for all outputs in total.

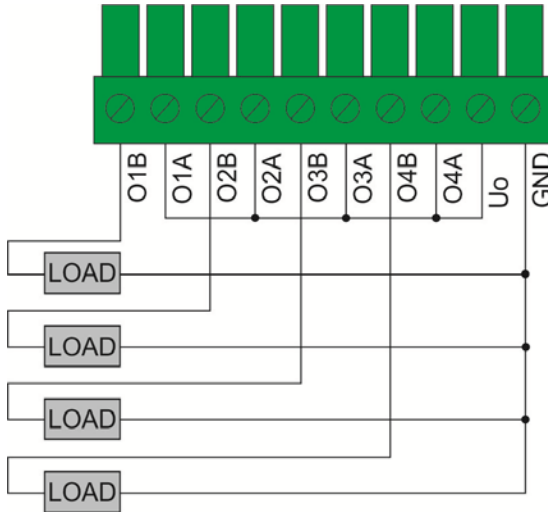

10.8.5. Passive Outputs in Ex Zone

Configuration intended to be used in hazardous area. Outputs load (LOAD) is powered using an external power supply.

The external power supply must be an intrinsically safe device characterized with features corresponding to the existing explosive atmosphere. The power supply must guarantee intrinsic safety parameters for the following conditions, $U_i=30V$ and $P_i=0.49W$.

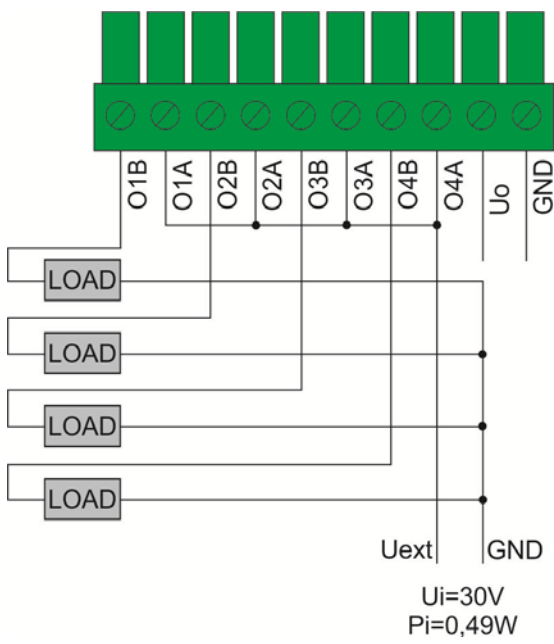

	<i>It is forbidden to connect electric potential and ground of internal power supply unit (U_0 and GND on IN/OUT interfaces terminals of the indicator) with an external intrinsically safe power supply. This would result with loss of intrinsic safety.</i>
	<i>All instruments connected to scale's digital IN/OUT require 'ia' or 'ib' protection.</i>



10.8.6. Passive Outputs Outside Ex Zone

Configuration intended to be used outside hazardous area. Outputs load (LOAD) is powered using an external power supply placed outside the hazardous area.

The power supply and the load (relay contacts) are connected via relevant „SWITCH AMPLIFIER”.

	<p><i>It is forbidden to connect electric potential and ground of internal power supply unit (Uo and GND on IN/OUT interfaces terminals of the indicator) with an external power supply. This would result with loss of intrinsic safety.</i></p>
	<p><i>All instruments connected to scale's digital IN/OUT require 'ia' or 'ib' protection.</i></p>

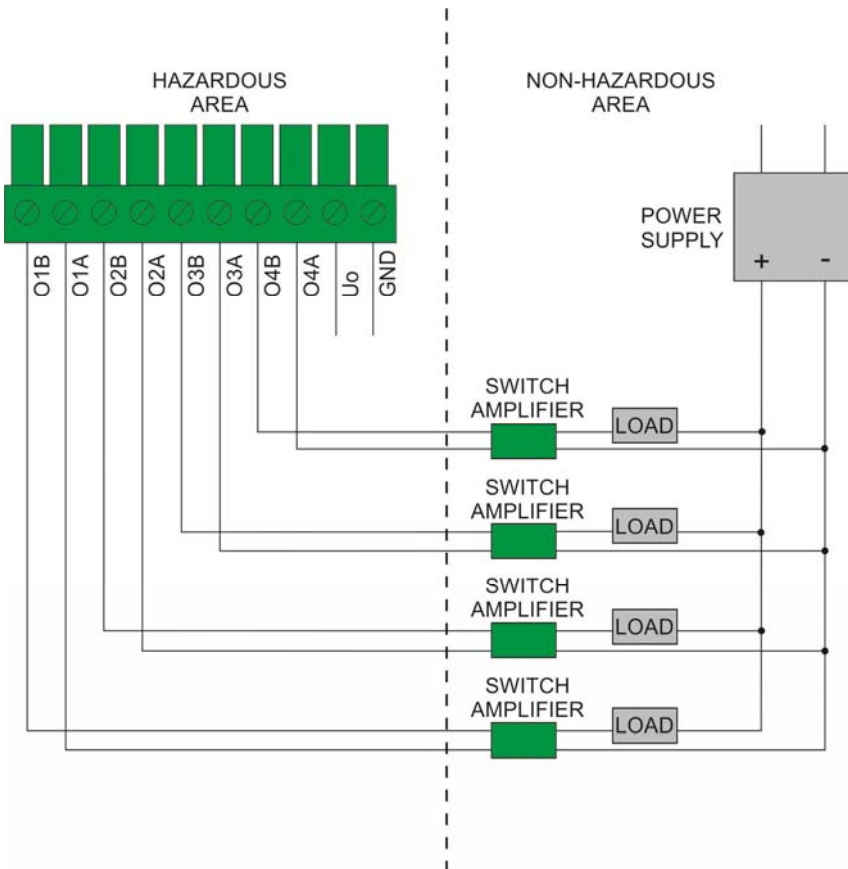

11. HX5.EX-* SCALES INSTALLATION

Prior the first use, carefully read this User Manual. Use the device only as intended.

RADWAG does not bear any responsibility for damage or losses resulting either from improperly carried out installation or misuse.



Prior installation and start, it is necessary to analyse whether the device complies with the usage requirements regarding particular hazardous area. The analysis must be carried out by a qualified personnel.

11.1. Unpacking

- The scale must be unpacked in safe area.
- Unpack the weighing platform, remove the transport lock (refers to one load cell platforms):

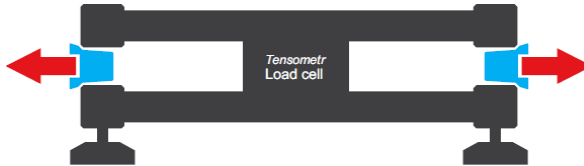

Transport lock

- Check grounding connectors' state. The grounding connectors guarantee discharge of weighing pan's electrostatic charges. The grounding springs must jut out ~5 mm above shock absorbers surface (refers to one load cell platforms).

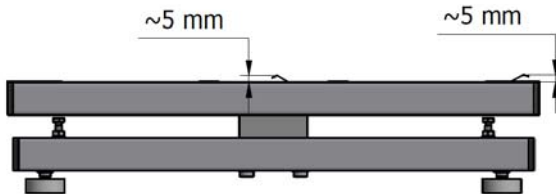

Grounding connectors

- Install the weighing pan and check resistance between point 1 – weighing pan and point 2 – grounding terminal. Permissible resistance must be of value lower than 100Ω (refers to one load cell platforms).

11.2. Preparing for Operation

- Select respective place of use for the HX5.EX-* scale.
- Place the scale at its workstation.
- Level the platform.
- Check resistance of all metal components.
- Ground the indicator.
- Connect the indicator to the mains.



Install the weighing indicator, place the weighing platform at the workstation, and connect the grounding when there is no risk of explosive atmosphere occurrence.

11.2.1. Workstation

HX5.EX-* scale's workstation requirements:

- Dry, even, horizontal surface.
- Ambient temperature range: -10°C - +40°C.
- No heat source in a close vicinity, no risk of intense temperature variation.
- No exposure of scale to drafts.
- No mechanical shocks and vibrations.
- No exposure of scale to mechanical or chemical stress (hazard).
- The workstation must be located in a considerable distance from processes where mechanisms causing electrostatic charges greater than those caused by rubbing the surface by hand, occur.
- No exposure of scale to sunlight.
- At the workstation there must be MEB (main equipotential bonding) installed.
- The workstation must be able to carry weight of the platform along with the measured load.

11.2.2. Installation at the Workstation

HX5.EX-* scales are devices intended to be permanently fixed at the workstation. It is forbidden to use the scale in the course of relocation.

The indicator can be either placed on a table or fixed to a wall.

It is not required to fix the HX5.EX-* scales to the surface in the course of installation. An exception are so called ramp scales with PL.4N.H platform.

Prior installation, mount steel bracket (2) onto foot base (1), do it using expanding ring (3), next screw the foot base (1) onto foot pin (4).

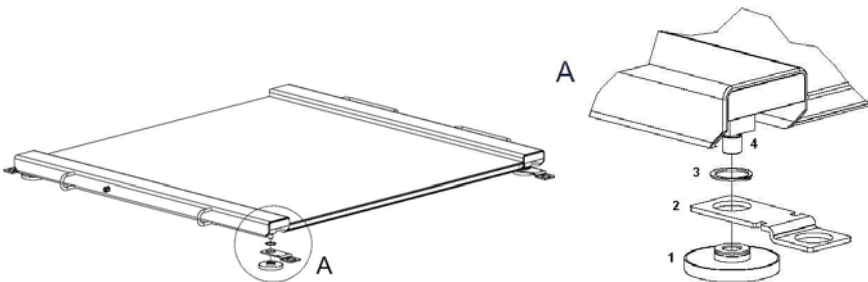

Place the scale at smooth, even surface. Mount ramps into the steel brackets. Dismount ramps, looking through brackets holes mark spots where openings for anchor bolts are to be made. Drill openings, mount anchor bolts, centring cones, washers and nuts, apply onto them the scale along with the steel brackets. Onto fixed steel brackets fit the ramps.

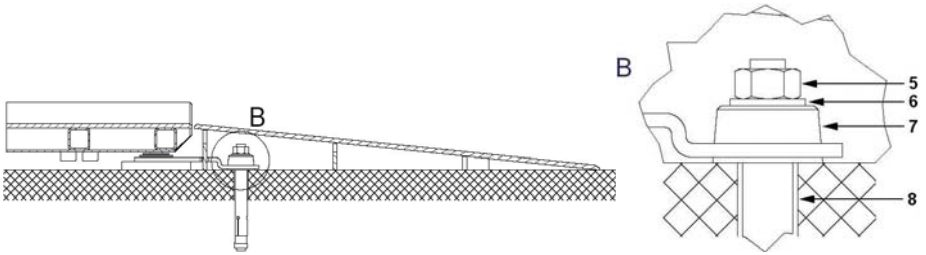

- 5 – nut
- 6 – washer
- 7 – centring cone
- 8 – anchor bolt

11.2.3. Levelling

It is necessary to level the scale, do it by turning its feet. Turn the feet until the air bubble takes central position.

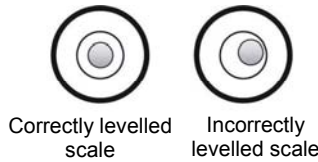

In case of multiple load cell scales the level adjustment range is limited. Correct level is provided by placing steel plates/washers under scale feet.

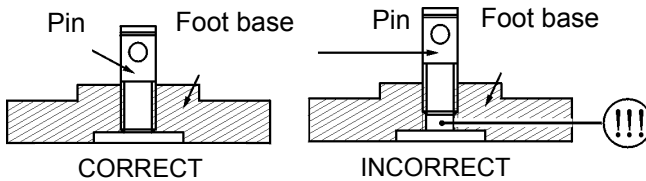

11.2.4. Checking Metal Components Resistance

11.2.4.1. One Load Cell Scales

Check grounding connectors' state. The grounding connectors guarantee discharge of weighing pan's electrostatic charges. The grounding springs must jut out ~5 mm above shock absorbers surface.

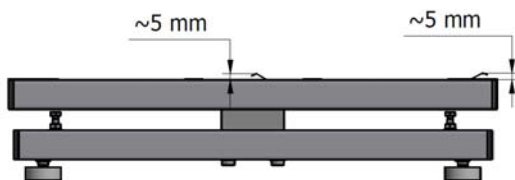

Grounding connectors

Install the weighing pan and check resistance between point 1 – weighing pan and point 2 – grounding terminal. Permissible resistance < 100 Ω.



It is NOT ALLOWED to use scale without weighing pan installed on.

11.2.4.2. Multiple Load Cell Scales

In case of multiple load cell scales, checking the resistance of metal components consists in measuring the resistance for two extreme parts. An exception are so called ramp scales with PL.4N.H platform.

In case of the ramp scales it is necessary to connect electrically the ramps, to do it use additional cables, see the below figure.

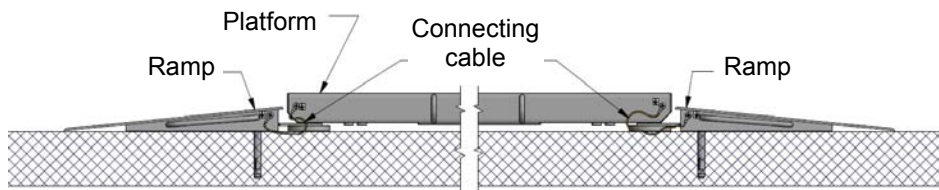

Permissible resistance between particular metal parts < 100 Ω.



11.2.5. Grounding



In order to remove electrostatic charges it is necessary to ground both the weighing indicator and the platform. Spots marked with „⊥” symbol are intended for the functional grounding cable.

- Prepare two functional grounding cables.
 - Use grounding cable of 4 mm² cross-section with yellow-green shield.
 - The functional grounding cable must be terminated with ring, of 5.2mm diameter, enabling you to couple the cable to the weighing indicator and the platform.

- Use either toothed clamping washer or lock washer in order to keep the ring pressed tightly against the housing.
- Connect one of the functional grounding cables to the equipotential bonding and to the weighing indicator. Connect the second cable to the equipotential bonding and to the platform.
- In case of scales with load cell modules, connect junction box to the functional grounding and check resistance of connection between modules and grounded construction of the cooperating silo. Permissible resistance $< 100 \Omega$. If the resistance is out of the permissible range, then it is necessary to connect each of the modules to the equipotential bonding individually.
- Both of the grounding cables must be connected to one and the same equipotential bonding.
- Permissible resistance between the grounding terminal and the equipotential bonding is lower than 100Ω .

	<p><i>Scale's grounding and grounding of cooperating devices must be connected to the same "equipotential circuit".</i></p>
	<p><i>Connect the grounding when there is no risk of explosive atmosphere occurrence.</i></p>

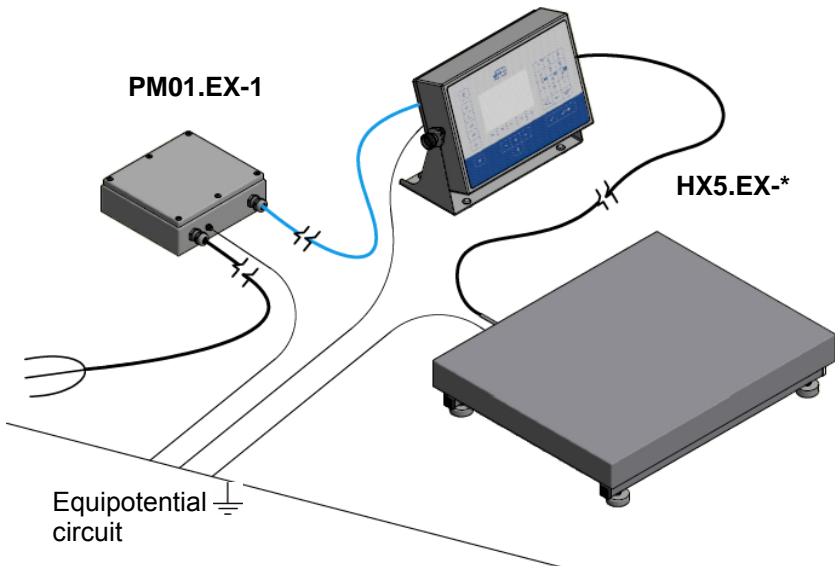



Scale's grounding

11.3. Connecting Power Supply

HX5.EX-* scale can be connected to the mains only with a certified intrinsically safe power supply, manufactured by RADWAG:

- **PM01.EX-1** power supply intended for operation in hazardous area:
 - zone 1 and 2 where there is a risk of explosion due to mixture of air with vapour, mist or gas, classified as explosion group IIC, IIB and IIA and as temperature class T1, T2, T3, T4.
 - zone 21 and 22 where there is a risk of explosion due to mixture of air with dust, flammable fibres and volatile fuels, classified as explosion group IIIC, IIIB and IIIA.
- **PM01.EX-2** power supply intended for operation in safe area, equipped with intrinsically safe circuits which may be placed in:
 - zone 1 and 2 where there is a risk of explosion due to mixture of air with vapour, mist or gas, classified as explosion group IIC, IIB and IIA and as temperature class T1, T2, T3, T4.
 - zone 21 and 22 where there is a risk of explosion due to mixture of air with dust, flammable fibres and volatile fuels, classified as explosion group IIIC, IIIB and IIIA.

Connection of the HX5.EX-* scale's indicator to power supply is carried out by the manufacturer at the stage on production, the connection is of fixed type. If there is a need to disconnect the power supply, e.g. in order to run the cable through walls etc., it is allowed to disconnect the power cord from the power supply only.

	<i>Disconnect the indicator from the power supply when there is no risk of explosive atmosphere occurrence.</i>
	<i>Prior 'indicator' - 'power supply' cable disconnection, it is necessary to disconnect the power supply from the mains first.</i>
	<i>Disconnect the cable from the power supply EXCLUSIVELY.</i>

Detailed information concerning connection and disconnection of the cable from the power supply is to be found in an attached "**PM01.EX Intrinsically Safe Power Supply User Manual**".

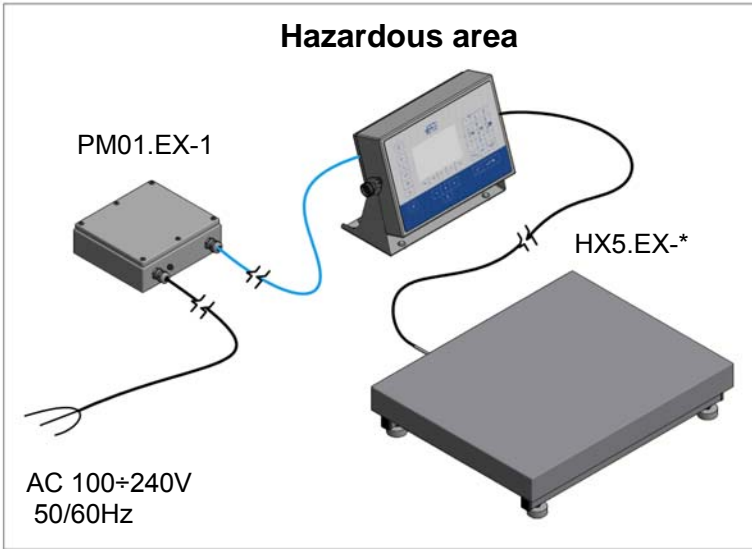

Scale with a power supply in hazardous area

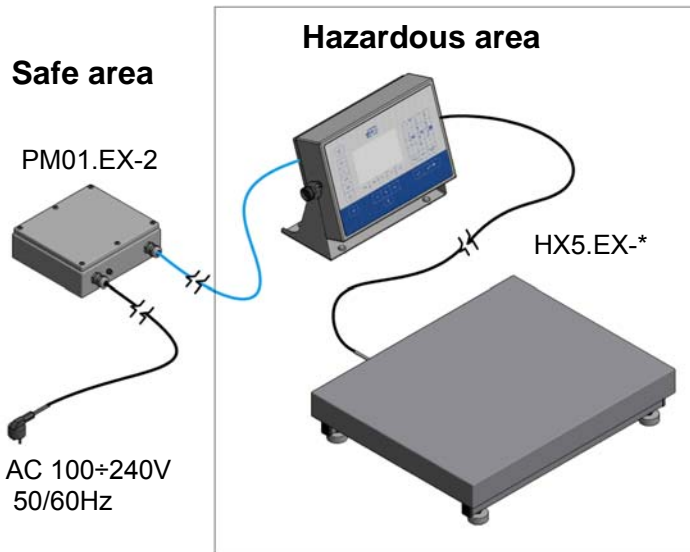

Scale with a power supply placed outside hazardous area

12. HX5.EX-* SCALE START-UP

- Press  key, it is to be found on the top of the operation panel.
- Upon completed start-up the home screen is displayed automatically.
- The scale is ready for operation.

Caution:

For detailed instruction on indicator's program read „**PUE HX5.EX Indicator Software Manual**”.

13. HOME SCREEN

The home screen features 4 sections:

- top bar,
- weighing result window,
- workspace,
- pictograms.

Home screen view:





13.1. Top Bar



The top bar displays the following information:

 Weighing	Working mode name and symbol.
PUE HX5.EX	Weighing device name.

	Symbol informing that printer is connected.
	Symbol informing that communication with a PC computer is on.

13.2. Weighing Result Window

Weighing result window provides all weighing related data.



13.3. Workspace

The workspace is to be found underneath the weighing result window.

Product:	Tare: 0.000 kg
User:	Sum: 0.000 kg

The workspace comprises 4 programmable widgets. Each working mode features default home screen widgets set. You can customize the screen. For detailed information concerning the workspace read section 'Display'.

13.4. Pictograms

The pictograms assigned to operation panel keys are to be found underneath the workspace.



You can define on-screen pictograms individually for each working mode.

	<i>For detailed information concerning the on-screen pictograms defining, read „PUE HX5.EX Indicator Software Manual”.</i>
---	---

14. OPERATING THE MENU

In order to navigate the program menu use the operation panel.





14.1. Entering the Menu

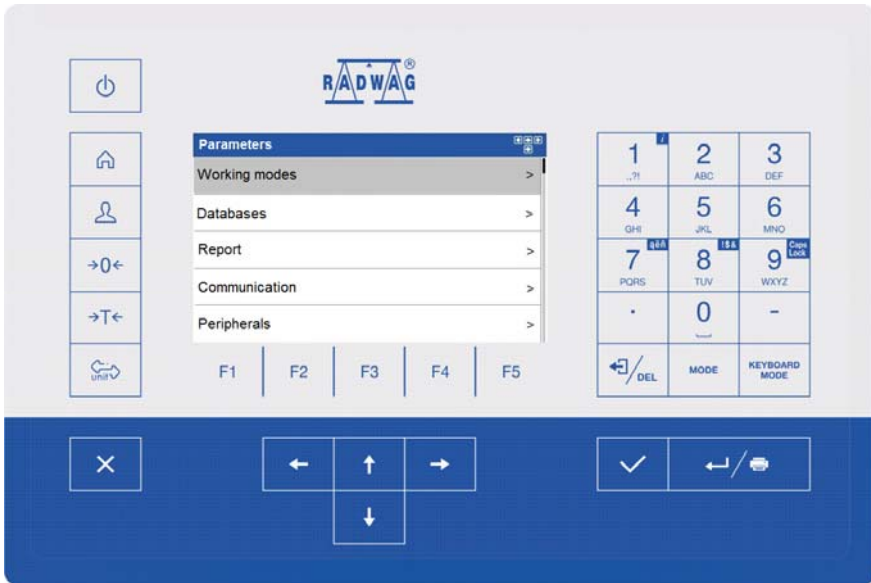





In order to enter the menu press  key of the operation panel. Background colour of the first menu position differs from the remaining ones. In order to navigate the program menu use the keys that operate as arrow keys.

Menu view



14.2. Menu Keys

	Press to enter the main menu. Press to go to home screen.
	Press to move one menu level up, or to discard entering parameter modifications.
	Press to move one menu level up. Press to delete a character when editing numeric and text values.
	Press to change keyboard mode when editing numeric and text values.

	Press to select/change working mode.
	Press to confirm/accept modifications.
	Press to move one menu level up, or to discard entering parameter modifications.
	Press to select higher-level parameters group, or to edit parameter value and change it by one digit up.
	Press to select parameters group that you want to operate. The first parameter of the selected parameters group is displayed.
	Press to select lower-level parameters group, or to edit parameter value and change it by one digit down.

14.3. Entering Numeric and Text Characters and Signs

Depending on a type of data entered to scale memory the software offers two different edit boxes:



- numerical box (for entering part mass values, tare values, etc.).
- text box (for entering printout template, universal variable value, etc.).

Button functions change depending on the edit box type.

	<i>For detailed instruction on numbers / text entering read „PUE HX5.EX Indicator Software Manual“.</i>
---	--

14.4. Return to the Weighing Mode

Introduced modifications are permanently recorded into scale memory upon return to the weighing operation, after carrying out saving procedure. To return to the home screen:

- press  key repeatedly, keep pressing the key until you see the home screen,
- press  key, the home screen is displayed immediately.

15. GOOD WEIGHING PRACTICE

Load the weighing pan. Read the result when  stability marker is displayed. In order to assure a long-term device operation, wherein correct measurements are provided, the following principles must be adhered to:

- Load the weighing pan steadily avoiding mechanical shocks.

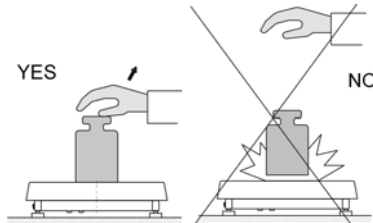

- Place weighed loads centrally on the weighing pan (eccentricity errors are specified by EN 45501 standard, points 3.5 and 3.6.2.).

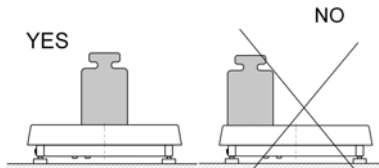

- Do not apply concentrated forces (all load in one point).

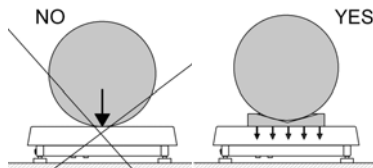

- Avoid side loading, in particular side shocks.

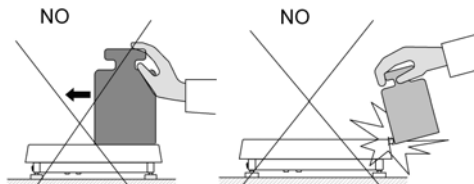

It is forbidden to apply load other than intended for a particular scale:

- ramp scales with PL.4N.H platform: it is necessary to select such platform which guarantees that casters of trucks, which truck's weight value is close to maximum capacity value, will transfer the load onto platform parts close to load-carrying sections:

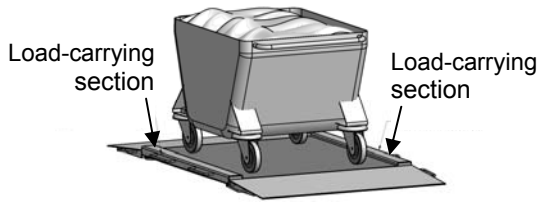

- pallet scales with PL.4P.C and PL.4P.H platforms (load placed on EUR-pallet using pallet truck): middle blocks of pallet placed on the scale must remain unsupported:

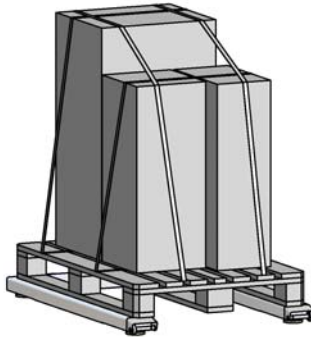

- beam scales with PL.4P2.C and PL.4P2.H platforms: self-supporting, rigid load or load placed in rigid load-transferring packaging:

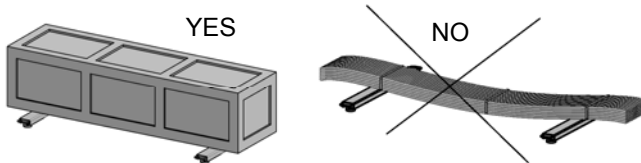

- four load cell scales, pit version – load weighed together with the truck:
 - combined weight value of the load and the truck cannot be greater than the permissible max capacity value,
 - the weighed truck when going down the weighing bridge cannot violently stop, it must go and start with the maximum permissible speed of 2km/h,
 - the truck must run onto the weighing bridge perpendicularly to the bridge edge in order to evenly transfer the load onto the sensors,
 - while loading the platform avoid shocks,
 - do not push or pull the load resting on the platform.

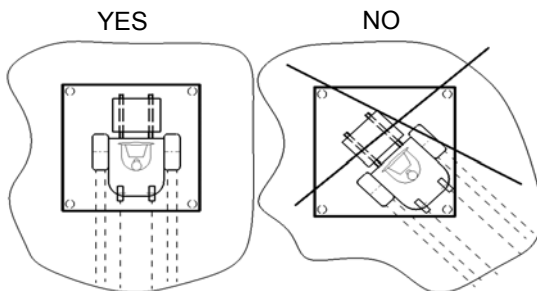

16. CONNECTION CABLES LIST

PT0327: scale – IM01 cable.

PT0328: scale – RS485 cable.

PT0329: scale – RS232 cable.

17. ERROR MESSAGES

	Max weighing threshold exceeded Unload the weighing pan
	Min weighing threshold exceeded Install weighing pan
	Zeroing out of range Press tarring button or restart the balance
	Display capacity out of range Unload the weighing pan
	Tarring out of range Press zeroing button or restart the balance



Start mass out of range
Install weighing pan



Zeroing/tarring time out of range
Weighing indication unstable

18. STANDARDS LIST

The device is manufactured in accordance with the following standards:

1. EN 61326-1:2013 *Electrical equipment for measurement, control and laboratory use - EMC requirements - Part 1: General requirements.*
2. EN 61010-1:2010 *Safety requirements for electrical equipment for measurement, control and laboratory use - Part 1: General requirements.*
3. EN 60079-0:2012 + A11:2013 *Explosive atmospheres - Part 0: Equipment - General requirements.*
4. EN 60079-11:2012 *Explosive atmospheres - Part 11: Equipment protection by intrinsic safety "I".*
5. EN 60529:1991 + A2:2013 *Degrees of protection provided by enclosures (IP Code).*



RADWAG BALANCES AND SCALES
ADVANCED WEIGHING TECHNOLOGIES

