

# H315

**1-LOAD-CELL MULTIFUNCTIONAL SCALES  
4-LOAD-CELL PLATFORM SCALES  
PALLET AND BEAM SCALES  
TRACK SCALES**

## USER MANUAL

ITKU-131-01-09-21-EN















**RADWAG®** RADWAG BALANCES AND SCALES  
ADVANCED WEIGHING TECHNOLOGIES

SEPTEMBER 2021

## PRECAUTIONS

Prior to installation, use or maintenance activities, carefully read this user manual and follow the provided guidelines.

	Prior to the first use, carefully read this user manual. Use the weighing device only as intended.
	Place weighed loads in the centre of the weighing pan.
	Load the weighing pan with loads of gross weight which does not exceed the maximum capacity.
	Mind not to leave heavy loads on the weighing pan for longer periods of time.
	Protect the indicator against considerable temperature variation, solar and UV radiation, substances causing chemical reactions.
	The HX7 indicator must not be operated in hazardous areas endangered with explosion of gases, and in dusty environments.
	In case of damage, immediately unplug the device from the mains.
	Scales to be decommissioned must be decommissioned in accordance with valid legal regulations.
	Do not let battery discharge in case of prolonged storage of the device in low temperature.
	A worn out battery can be replaced only by the manufacturer or by the authorized service.
	Accumulators do not belong to regular household waste. The European legislation requires discharged accumulators to be collected and disposed separately from other communal waste with the aim of being recycled. Symbols on batteries identify harmful compounds: Pb = lead, Cd = cadmium, Hg = mercury. Dear user, you are obliged to dispose of the worn out batteries as regulated.
	If the scale is to be operated in conditions that are difficult due to electrostatics (e.g. printing house, packing centre, etc.), you must connect it to the earth wire. To enable this, the device features functional earthing terminal, marked with $\perp$ symbol.

# Contents

<b>1. INTENDED USE</b> .....	<b>5</b>
<b>2. WARRANTY CONDITIONS</b> .....	<b>5</b>
<b>3. MAINTENANCE ACTIVITIES</b> .....	<b>5</b>
3.1. Cleaning Stainless Steel Components .....	6
3.2. Cleaning ABS Components .....	6
3.3. Cleaning Platform Scales for Meat Industry .....	6
<b>4. SERVICE AND REPAIR</b> .....	<b>8</b>
<b>5. RECYCLING</b> .....	<b>8</b>
<b>6. MECHANICAL DESIGN</b> .....	<b>9</b>
6.1. 1-Load-Cell Scales .....	9
6.2. Multiple Load Cell Scales .....	9
6.3. Scales with Load-Cell Modules .....	10
6.4. Dimensions .....	11
6.5. Connectors Arrangement .....	11
6.6. Pins Arrangement .....	11
6.7. Operation panel .....	12
<b>7. SCALE INSTALLATION</b> .....	<b>13</b>
7.1. Unpacking and Installation .....	13
7.1.1. Scales H315.xx.K Series .....	13
7.1.2. Scales H315.Cx.M Series .....	13
7.1.3. Scales H315.4 Series .....	14
7.2. Levelling .....	15
7.2.1. Levelling: 1-Load-Cell Platform Scales .....	15
7.2.2. Levelling: 4-Load-Cell Platform Scales .....	15
7.3. Start-Up .....	16
7.4. Battery Charge Status .....	16
7.5. Battery Charge Status Check .....	16
<b>8. OPERATING THE MENU</b> .....	<b>17</b>
8.1. Return to the Weighing Mode .....	17
<b>9. WEIGHING</b> .....	<b>17</b>
9.1. Operation conditions for 1-load-cell-scales .....	17
9.2. Operation conditions for special scales .....	18
<b>10. DIAGRAMS OF CONNECTION CABLES</b> .....	<b>20</b>
<b>11. TECHNICAL SPECIFICATION</b> .....	<b>21</b>
<b>12. TROUBLESHOOTING</b> .....	<b>21</b>
<b>13. ERROR MESSAGES</b> .....	<b>22</b>

## 1. INTENDED USE

H315 series scales enable fast and accurate mass measurement in industry. The scales are equipped with a stainless steel housing of high IP. Clear weighing result presentation is ensured due to a large display (LCD). The devices can optionally be equipped with an internal battery which allows their operation in places where there is no access to the mains.

Standard H315 scales feature RS232 and USB interfaces for communication with external devices (printer, computer, etc.) and offers wireless communication.

## 2. WARRANTY CONDITIONS

- A. RADWAG feels obliged to repair or exchange all elements that appear to be faulty by production or by construction.
- B. Defining defects of unclear origin and means of their elimination can only be realized with the assistance of the manufacturer and the user representatives.
- C. RADWAG does not bear any responsibility for damage or losses resulting from unauthorized or inadequate performing of production or service processes.
- D. The warranty does not cover:
  - mechanical damage caused by product exploitation other than intended, damage of thermal and chemical origin, damage caused by lightning, overvoltage in the power network or other random event,
  - inappropriate cleaning habits.
- E. Loss of warranty takes place if:
  - a repair is carried out outside an authorized service point,
  - service claims intrusion into mechanical or electronic construction by unauthorized people,
  - the scale does not bear security seal stickers.
- F. Warranty conditions outline the warranty period for rechargeable batteries attached to the device for 12 months.
- G. For detailed warranty conditions read the warranty certificate.
- H. Contact with the central authorized service: +48 (48) 386 63 30.

## 3. MAINTENANCE ACTIVITIES

In order to ensure safety in the course of cleaning, it is necessary to disconnect the device from the mains. With this condition met, uninstall the weighing pan and other detachable components.



***Cleaning the weighing pan while still installed may cause damage of the measuring system.***

### **3.1. Cleaning Stainless Steel Components**

Avoid cleansers containing any corrosive chemicals, e.g. bleach (including chlorine). Do not use cleansers containing abrasive substances. Always remove the dirt using microfiber cloth to avoid damage of protective coating. In case of a daily maintenance:

1. Remove the dirt using cloth dipped in warm water.
2. For best results, add a little bit of dishwashing detergent.

### **3.2. Cleaning ABS Components**

To clean dry surfaces and avoid smudging, use clean non-colouring cloths made of cellulose or cotton. You can use a solution of water and detergent (soap, dishwashing detergent, glass cleaner). Gently rub the cleaned surface and let it dry. Repeat the cleaning process if needed.

In the case of hard to remove contamination, e.g. residues of adhesive, rubber, resin, polyurethane foam etc., you can use a special cleaning agents based on a mixture of aliphatic hydrocarbons that do not dissolve plastics. Before using the cleanser for all surfaces we recommend carrying out tests. Do not use cleansers containing abrasive substances.

### **3.3. Cleaning Platform Scales for Meat Industry**

Platforms of meat industry scales are made of stainless steel (0H18N9 by PN, 1.4301 by EN, 304 by AISI) and silicone components.

Exceptions are zink-plated track scales made of galvanized steel and powder-coated livestock scales with aluminium insert placed on the weighing pan.



***Cleaning and disinfecting agents must be properly selected with regard to the scale.***

In case of livestock scales, for commercial purposes it is necessary to use only stainless steel solutions.

These are much more resistant to long-lasting harsh conditions typical for slaughterhouses and livestock purchase sites. Powder-coated livestock scales can be used for rare small volume production, they must be stored clean in dry storage area and can be washed using water with a detergent.

Do not use any agents or cleansers that are not intended to come into contact with skin (i.e. requiring use of protecting gloves).

In case of track scales it is forbidden to use chemicals containing penetrating substances. Grease and impurities accumulating in places where the scale track touches the line track must be cleaned off periodically.

Weighing indicators of all scales feature stainless steel housings, polyester overlay and polyamide glands. Platforms of both livestock and ramp scales, their load-bearing structures and weighing tracks can be water-jet cleaned, the water temperature must be up to +80°C, respective cleanser needs to be added. When it comes to indicators, it is forbidden to apply water-jet cleaning method, use of hot water is not allowed. It is recommended to cover the indicators for the time of pressure washing of the surroundings.

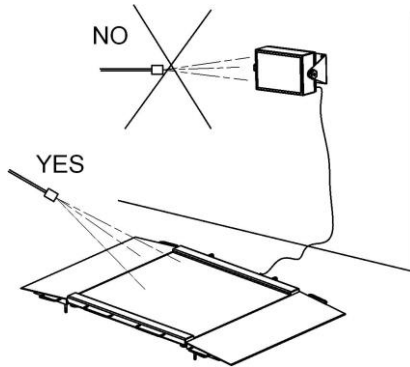

While cleaning platforms and indicators of waterproof platform scales do not use either intense water jet or hot water, this is to avoid damage of silicone bellow of platform sensor cover and indicator's operation panel or glands. Platforms of platform scales can be water-jet cleaned when uninstalled, they can also be cleaned by immersion into water.

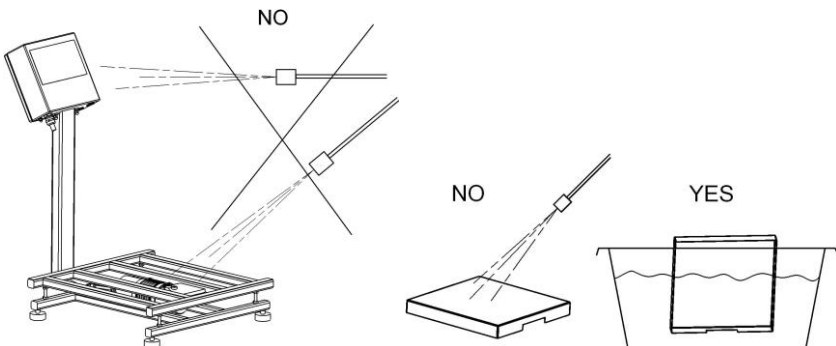

	Ramp scales		Livestock scales		Track scales		Waterproof platform scales		
	Platform with ramps	Weighing indicator	Platform with cage	Weighing indicator	Load-bearing structure with a load cell	Weighing indicator	Platform	Weighing indicator	Uninstalled pan
<b>Water with detergents</b>	Yes	Yes	Yes	Yes	Yes	Yes	Yes	Yes	Yes
<b>Intense water jet</b>	Yes	No	Yes	No	Yes	No	No	No	Yes
<b>Hot water, 80°C max</b>	Yes	No	Yes	No	Yes	No	No	No	Yes

#### 4. SERVICE AND REPAIR

	<p><b><i>In case of any sign of damage, it is necessary to disconnect the device from the mains immediately. The damaged component must be replaced or repaired by RADWAG service directly.</i></b></p>
---	---

In case of any problems with correct operation of the scale, contact the closest manufacturer's service point.

In case of defects, deliver the faulty product to the manufacturer's service point. If the product cannot be delivered to the manufacturer's service point, call the service and report the defect. Repair scope and method will be set up.

	<p><b><i>The user is NOT ALLOWED to carry out any kind of repair of the device himself/herself. Any attempt of scale modification, repair etc., by unauthorized persons, will result with loss of validity of manufacturer-issued certificates, declarations and warranty.</i></b></p>
---	--

#### 5. RECYCLING

HX7 scales must be recycled, they are not to be treated as a regular household waste. Scales to be decommissioned must be decommissioned in accordance with valid legal regulations.





## 6. MECHANICAL DESIGN

### 6.1. 1-Load-Cell Scales

1-load-cell H315 scale is intended to carry out fast and precise mass measurement of up to 300 kg loads. Its characteristic feature is a platform with one load cell only. The platform is equipped with a stainless steel weighing pan. Depending on a scale model, the cross and base are made of either stainless steel or powder-coated steel.

1-load-cell scale design, the main components

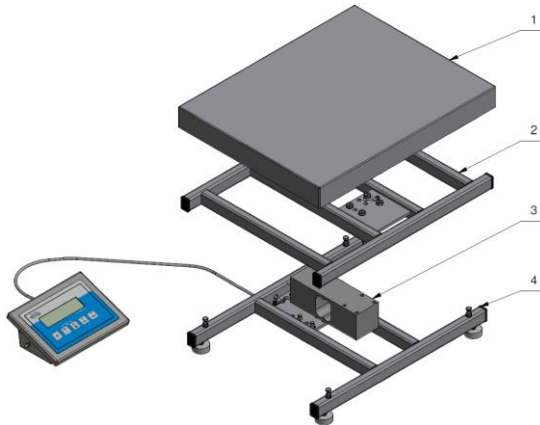

*1-load-cell scale design, the main components:  
1 - weighing pan, 2 - cross, 3 - load cell, 4 - base.*

### 6.2. Multiple Load Cell Scales

Multiple load cell H315 scale is intended to carry out fast and precise mass measurement of large loads. Its characteristic feature is a platform equipped with numerous load cells, usually four. The platform, depending on a scale model, is made of stainless steel or powder-coated steel, it features customized mechanical design suiting particular customer's requirements (pallet, beam, platform scales).

## Multiple load cell scale design, the main components

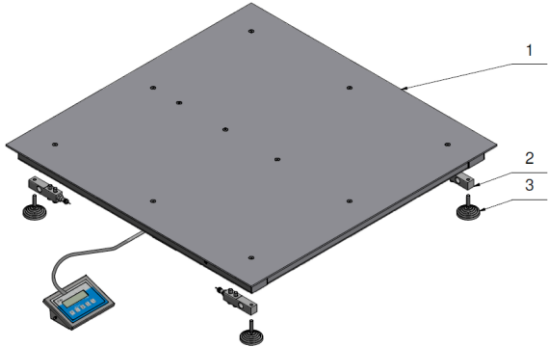

*Multiple load cell scale design, the main components:  
1 - weighing pan, 2 - load cells, 3 - feet.*

### 6.3. Scales with Load-Cell Modules

H315 scale with load cell modules is intended to carry out mass measurement of silos. Modules are built into construction of ground-fixed silo's support. In most cases, the scale design includes 3-4 load cell modules. The modules, depending on the model, are made of stainless or galvanized steel.

Scale design, the main components

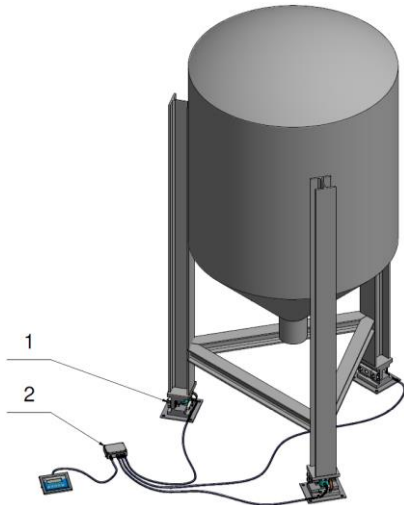

*Scale design, the main components:  
1 - module, 2 - junction box.*

## 6.4. Dimensions

For overall dimensions read product card of a respective scale, the product cards are to be found on RADWAG website [www.radwag.pl](http://www.radwag.pl).

## 6.5. Connectors Arrangement

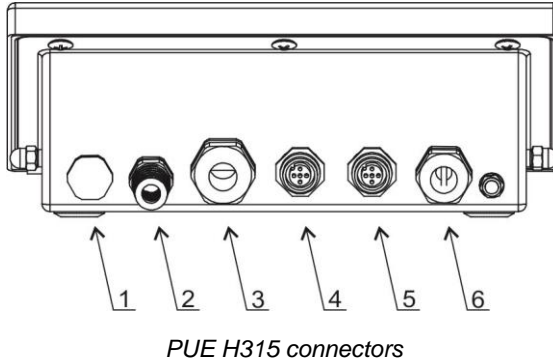

1	Vent
2	Power cord
3	Platform
4	USB connector
5	RS232 (1) connector
6	Universal socket or gland (RS232 (2) or RS485 or Ethernet or IN/OUT)





## 6.6. Pins Arrangement

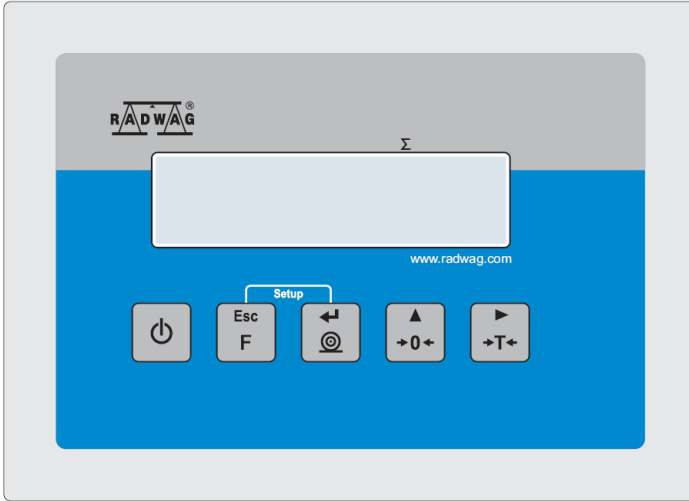



RS232 (1) RS232 (2)		Pin1 – NC Pin2 – RxD Pin3 – TxD Pin4 – NC Pin5 – GND Pin6 – 5VDC Pin7 – NC Pin8 – NC
USB		Pin1 – Vcc Pin2 – D- Pin3 – D+ Pin4 – GND
Ethernet		Pin1 – RX+ Pin2 – TX+ Pin3 – RX- Pin4 – TX-

## 6.7. Operation panel



### Keys:

	Press to switch the weighing device on/off – hold the key for about 1 second.
	Function key, press to change the working mode.
	Press to send the weighing result to a printer or computer.
	Press to zero the scale.
	Press to tare the scale.

	<p><b>Upon pressing  +  keys combination, functions of given keys change. Detailed information concerning use of the  +  keys combination is to be found further down this manual.</b></p>
---	--

## 7. SCALE INSTALLATION

### 7.1. Unpacking and Installation



***Mind not to damage cable connecting the indicator and a weighing platform.***

#### 7.1.1. Scales H315.xx.K Series

- Take the device out of the packaging.
- Place the device on a flat and even surface. Keep it far away from any sources of heat.
- Remove transport locks and install the weighing pan:

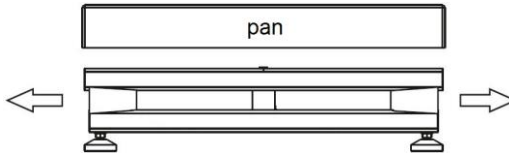

#### 7.1.2. Scales H315.Cx.M Series

- Take the device out of the packaging.
- Place the device on a flat and even surface. Keep it far away from any sources of heat.
- Remove transport locks and install the weighing pan:

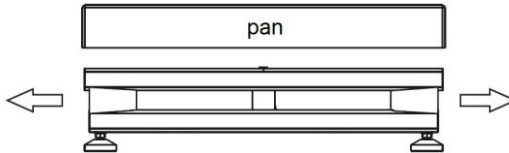

- Fix the post to the scale, next fix the indicator to the post:

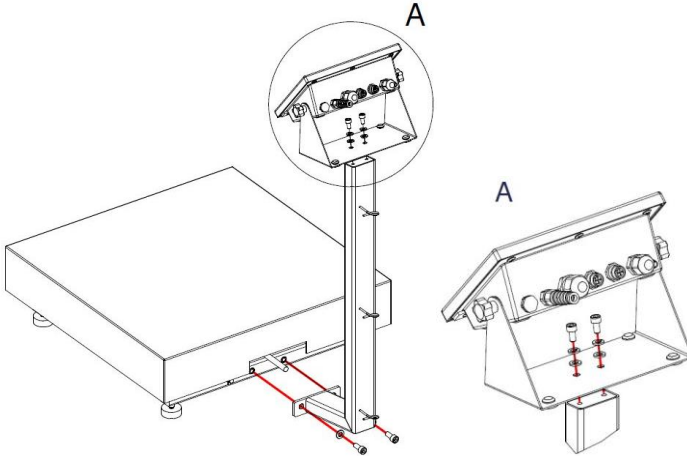

- Run the cable through cable clips:

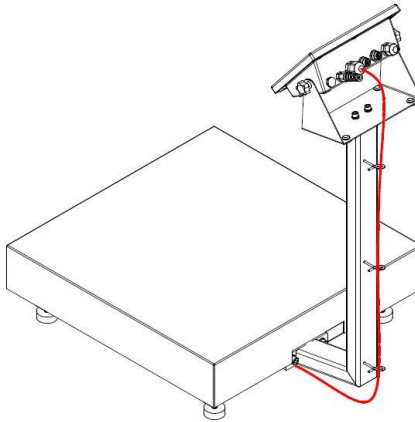

### 7.1.3. Scales H315.4 Series

- Take the device out of the packaging (pallet).
- Place the device on a flat and even surface. Keep it far away from any sources of heat.
- Remove transport locks (if installed):

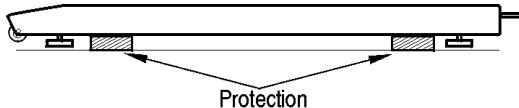

- Fix the feet (if not installed):

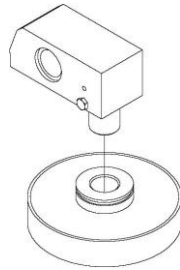

## 7.2. Levelling

### 7.2.1. Levelling: 1-Load-Cell Platform Scales

It is necessary to level the scale, do it by turning its feet. Keep turning the feet until the air bubble takes central position.

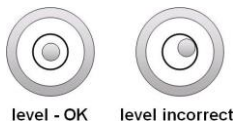

### 7.2.2. Levelling: 4-Load-Cell Platform Scales

To level the scale use the levelling feet and the level indicator. Each foot can be turned left and right, turning causes tilt. Adjustment span of the scale level is narrow therefore the correct level is obtained using steel washers which are to be put under the feet.

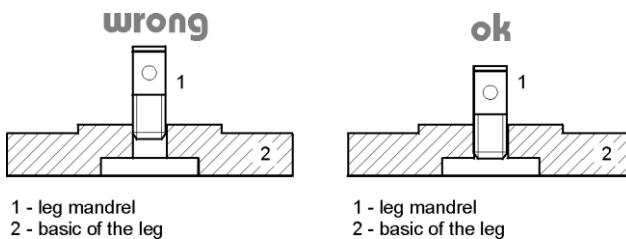

Keep turning the feet until the air bubble takes central position.

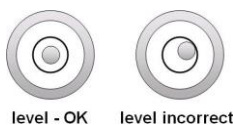

### 7.3. Start-Up



- Plug the power cord to the mains.
- Press  button. The key is also used to switch the scale on/off.
- Display test proceeds (all symbols are backlit for a moment), program name and number is displayed first, mass indication next.

### 7.4. Battery Charge Status

The scale of standard design is equipped with an internal battery. Battery state is signalled by  pictogram, the pictogram is displayed in the top bar of the display.

 pictogram display mode	Meaning
No pictogram	Battery charged. Regular scale operation.
Pictogram displayed continuously	Too low battery charge (the scale is about to shut down). Charge the battery immediately.
Blinking pictogram, blink frequency: ca. 1 s	Battery charge in progress. The device is connected to the power supply charging the battery.
Blinking pictogram, blink frequency: ca. 0.5 s	Battery error. Battery is damaged.

### 7.5. Battery Charge Status Check

- Press  and  keys combination.
- Depending on the battery state, a respective status is displayed on the screen for 2s:













<b>80%</b>	Battery power supply. Battery power given in %.
<b>CHARGE</b>	Battery charge in progress. The device is connected to the power supply charging the battery.
<b>-Err5-</b>	Battery error. Battery is damaged.

- Next, the home screen is displayed automatically.



## 8. OPERATING THE MENU

In order to navigate the program menu use the operation panel.

 + 	Press to enter the main menu.
 + 	Press to enter tare manually. Press to enter tare from tare database. Press to change value by 1 digit up. Press to scroll the menu up.
 + 	Press to check battery/accumulator state.
 + 	Press to view date/time.
	Press to scroll the menu down. Press to change current parameter value.
	Press to enter given submenu. Press to modify given parameter.
	Press to confirm modification.
	Press to exit, function remains unmodified. Press to move one menu level up.

### 8.1. Return to the Weighing Mode

Introduced menu modifications are automatically saved to scale memory upon return to the home screen. To return to the home screen press  key repeatedly.

## 9. WEIGHING

Load the weighing pan. Read the result when  stability marker is displayed.

### 9.1. Operation conditions for 1-load-cell-scales

To assure long-term operation and correct mass measurements, follow the rules presented below:

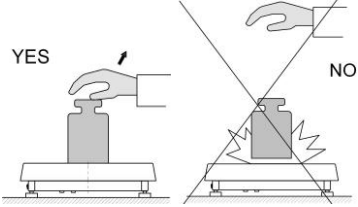
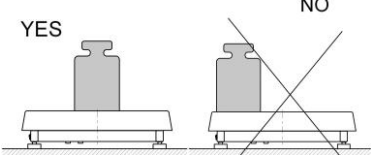
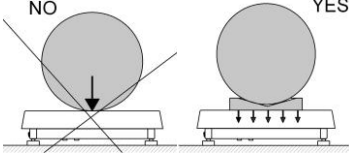
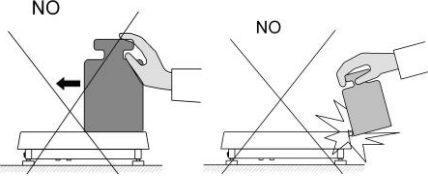
<p>Load the weighing pan steadily, avoid mechanical shocks.</p>	
<p>Place weighed loads centrally on the weighing pan (eccentricity errors are specified by EN 45501 standard, point 3.6.2.).</p>	
<p>Do not apply concentrated force (total load in one point).</p>	
<p>Avoid side loading, in particular side shocks.</p>	

## 9.2. Operation conditions for special scales

It is forbidden to apply load other than intended for a particular scale:

- beam scales; self-supporting, rigid load or load placed in rigid load-transferring packaging:

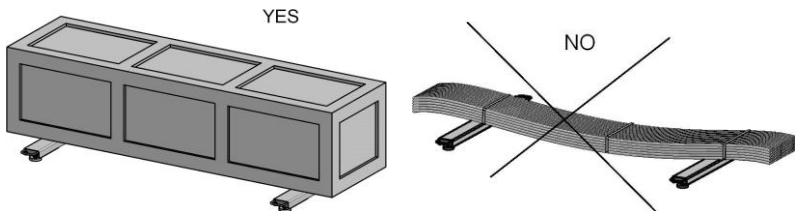

- pallet scales (load placed on EUR-pallet using pallet truck); middle block of pallet placed on the scale must remain unsupported:

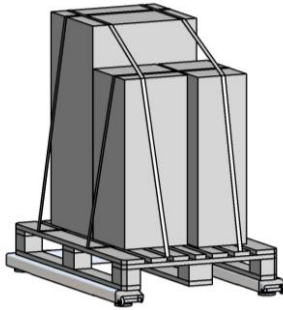

- ramp scales (trucks used in meat plants); it is necessary to select platform matching the span of truck casters, this is to make sure that in case of trucks of weight close to maximum capacity the load is transferred onto platform close to load-carrying sections (profiles):

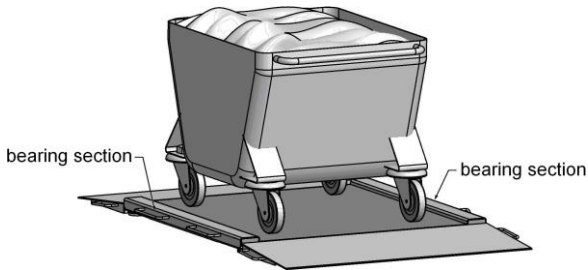

- track scales (product hanging on a hook) intended to slide:
  - hooks suiting a particular track and scale,
  - smooth slide down the track, no jerky moves, no swinging left or right,
  - evenly loaded track.

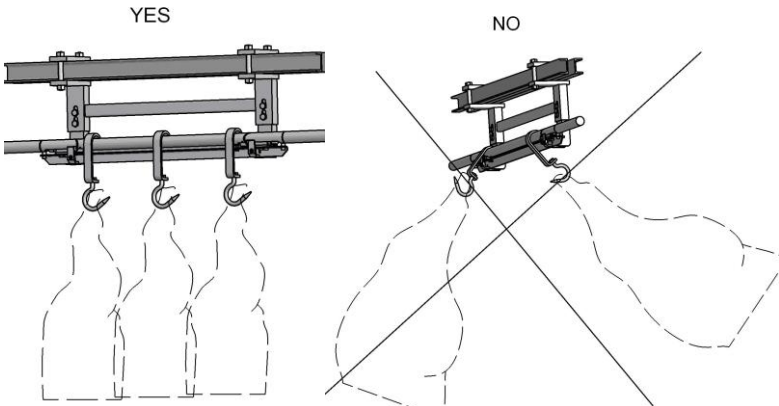



## 11. TECHNICAL SPECIFICATION

For technical specifications of respective scales go to RADWAG website [www.radwag.pl](http://www.radwag.pl).

## 12. TROUBLESHOOTING

Problem	Cause	Solution
Scale start-up fail.	Unplugged power cord plug.	Plug the power cord plug.
	Battery discharged.	Plug the power cord plug and charge the battery.
	No battery (not installed or installed incorrectly).	Check if the battery is installed correctly (polarization).
The scale switches off automatically.	<7.4.t1> parameter set to value enforcing scale shut-down after particular time interval.	Go to <P7.Othr> menu, set <7.4.t1> parameter to 'nonE' value.
During the start-up, message 'LH' is displayed.	Weighing pan loaded during the start-up.	Unload the weighing pan. Zero indication is displayed.
Communication with the computer not established.	Incorrect computer port set in parameter <5.1.1.Prt>.	Enter < P5.ducE / 5.1.PC> submenu and set correct <5.1.1.Prt> parameter value.
	Incorrect transmission parameters for the selected computer port.	Enter <P4.Conn> menu and set correct transmission parameters for the selected computer port.
	Incorrect printout frequency for continuous transmission.	Enter < P5.ducE / 5.1.PC> submenu and set correct <5.1.3.Int> parameter value.
No printout on a scale-connected printer.	Incorrect printer port set in <5.2.1.Prt> parameter.	Enter < P5.ducE / 5.2.Prtr> submenu and set correct <5.2.1.Prt> parameter value.
	Incorrect transmission parameters for the selected printer port.	Enter <P4.Conn> menu and set correct transmission parameters for the selected printer port.
	No variable declared in weighing printout project.	Enter <P6.Prt / 6.2.GLP> submenu and declare variables that are to be printed.
Communication with the additional display not established..	Incorrect additional display port set in <5.3.1.Prt> parameter.	Enter < P5.ducE / 5.3.AdSP> submenu and set correct <5.3.1.Prt> parameter value.
	Incorrect transmission parameters for the selected computer port.	Enter <P4.Conn> menu and set correct transmission parameters for the selected additional display port.
Displayed mass unit does not comply with the scale data plate.	Changed scale start unit in <9.1.UnSt> parameter.	Enter <P9.Unit / 9.1.UnSt> submenu and set unit complying with the scale data plate.
	Changed custom unit in <9.2.Unin> parameter.	Enter <P9.Unit / 9.2.Unin> submenu and set unit complying with the scale data plate.

### 13. ERROR MESSAGES

-Err2-	Value beyond zero range.
-Err3-	Value beyond tare range.
-Err4-	Adjustment weight or start mass out of range ( $\pm 1\%$ for adjustment weight, $\pm 10$ for start mass).
-Err5-	Battery error. Battery is damaged.
-Err8-	Time of the following operations exceeded: taring, zeroing, start mass determining, adjustment process.
-null-	Zero value from converter.
-FULL-	Weighing range exceeded.
-LH-	Start mass error, indication out of range ( $\pm 10\%$ of start mass).
-Hi-	Display range of total mass on scale display exceeded in 'Totalizing' mode.
-uLo-	Too low battery charge. The scale is about to shut down.
-ErrLo-	<ul style="list-style-type: none"> <li>- Determined mass of single part in 'Parts counting' mode too small.</li> <li>- Value of 'Min' threshold is greater than value of 'Max' threshold in '+/- control' mode.</li> </ul>
-ErrHi-	<ul style="list-style-type: none"> <li>- Entered value of single part greater than maximum capacity in 'Parts counting' working mode.</li> <li>- Entered value of 'Max' threshold greater than maximum capacity in '+/- control' mode.</li> <li>- Entered reference mass greater than maximum capacity in 'Percent weighing' mode.</li> </ul>



**RADWAG BALANCES AND SCALES**  
ADVANCED WEIGHING TECHNOLOGIES

