

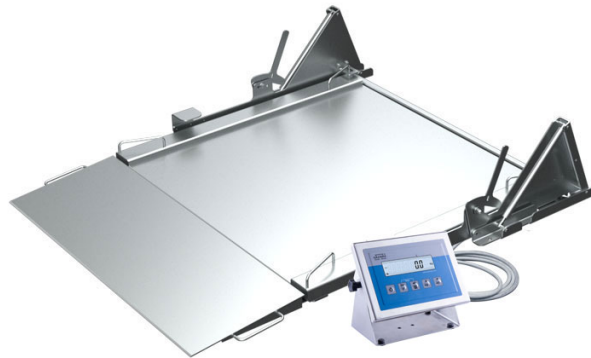

More information on the website  
[mirror.radwag.com/en/info,w1,ZW4](http://mirror.radwag.com/en/info,w1,ZW4)

# H315.4N.600.H2.LD Stainless Steel Ramp Scale

WP-234-0019



The drawings, photos and graphics used are for illustrative purposes only.

## Functions

 Plus/Minus Control

 Percent Weighing

 Totalizing

 Parts counting

 Internal battery

 Peak hold

 Newton unit measurement

 Animal weighing

## Datasheet

Metrological parameters	
Maximum capacity [Max]	600 kg
Minimum load	4 kg
Readability [d]	200 g
Verification unit [e]	200 g
Tare range	-600 kg
Max readability for non-verified scale	100 g
OIML Class	III

Physical parameters	
Display	4.3" LCD (backlit)
Cable length	3 m
Weighing pan dimensions	1100×1200 mm
Packaging dimensions W x D x H	1640×1590×580 mm
Net weight	175 kg
Gross weight	300 kg
Construction	
Protection class	IP 66 / 69 construction, IP 66 / 67 / 69 terminal
Communication interface	
Communication interface	RS232, USB
Optional interfaces	RS232 or RS485 or 4IN/4OUT or Ethernet or analog output 4-20 mA
Electrical parameters	
Power supply	100 – 240 V AC 50/60 Hz
Optional power supply	internal rechargeable battery
Operation time on batteries	max 7h
Environmental conditions	
Operating temperature	-10 – +40 °C
Relative humidity	10% – 85% RH no condensation



Additional fee for verification



## Accessories (Additional Fee)

AP2-4 Current Loop Unit  
 RS 232 cables (scale - printer)  
 Displays  
 Ethernet cables (scale - Ethernet)  
 RS 232, RS 485 cables  
 Power Adapters

RS 232 – Ethernet Converter  
 USB adapter  
 Receipt Printer  
 USB cable (scale - printer)  
 Stands, wall mounting kits and mounting brackets  
 RS 232 – USB Converter

## Software (Additional Fee)

- RAD Key [WX-010-0005]
- Scale Editor 2.1 [WX-010-0173]

- R-Lab [WX-010-0080]

## Device dimensions W x D x H



	A [mm]	B [mm]	C [mm]	D [mm]
H315.4N.150.H1.LD	840	860	45	426
H315.4N.300.H1.LD	840	860	45	426
H315.4N.600.H1.LD	840	860	45	426
H315.4N.150.H2.LD	1100	1200	45	426
H315.4N.300.H2.LD	1100	1200	45	426
H315.4N.600.H2.LD	1100	1200	45	426
H315.4N.300.H3.LD	1200	1500	45	426
H315.4N.600.H3.LD	1200	1500	45	426
H315.4N.1500.H2.LD	1100	1200	52	476
H315.4N.1500.H3.LD	1200	1500	52	476
H315.4N.300.H4.LD	1500	1500	52	476
H315.4N.600.H4.LD	1500	1500	52	476
H315.4N.1500.H4.LD	1500	1500	52	476