



# HY10.15.H3/5.K Çok Fonksiyonlu Terazı



















WP-116-0067

More information on the website  
[mirror.radwag.com/tr/info,w1,Z91](http://mirror.radwag.com/tr/info,w1,Z91)



The drawings, photos and graphics used are for illustrative purposes only.

## Fonksiyonlar

-  Dosing
-  Labelling
-  Plus/Minus Control
-  Percent Weighing
-  Totalizing
-  Parts counting
-  Peak hold
-  Formulation
-  Newton unit measurement
-  Statistics
-  Checkweighing
-  GLP Procedures
-  Animal weighing
-  Differential weighing
-  Replaceable unit
-  Statistical Quality Control
-  ALIBI Memory
-  Transactions

## Teknik Veriler

Metrolojik parametreler	
Maksimum yük [Max]	15 kg
Minimum yük [Min]	200 g
Okuma için ğruluđu [d]	10 g
Yasallařtırma birimi [e]	10 g

Metrolojik parametreler	
Dara aralığı	-30 kg
Ayarlama	harici
OIML sınıfı	III
Fiziksel parametreler	
Display	10,1" grafik renkli dokunmatik
Kablo uzunluğu	2,5 m
Tartım kefi boyutları	400x600 mm
Ambalaj boyutları G x D x Y	490x680x460 mm
Net ağırlık	16 kg
Brüt ağırlık	18 kg
Konstrüksiyon	
IP Sınıfı	IP 66 / 67 konstrüksiyon, IP 66 / 67 / 69 terminal
Haberleşme arayüzler	
Haberleşme arayüzü	2xRS232, 2xUSB-A, Ethernet, 4 IN / 4 OUT (dijital)
Opsiyonel arayüzler	modül Wi-Fi 802.11 b/g/n, modül Profibus (DP SLAVE), modül RS485, modül PROFINET (RJ45), analog çıkış modülü (4-20mA, 0-20mA, 0-10V), 12IN / 12OUT (IN – 5-24 VDC, OUT – max 30 VDC, 0,5 ADC)
Elektrik parametreleri	
Güç kaynağı	100 – 240 V AC 50/60 Hz
Çevresel koşullar	
Çalıştırma sıcaklığı	-10 – +40 °C
Atmosferik nem	10% – 85% RH yoğunlaşma yok

\* Wi-Fi® is a registered trademark of Wi-Fi® Alliance.



Additional fee for verification



## Aksesuarlar (Additional Fee)

AP2-4 Güç döngüsü çıkışı  
RS 232 Kablolar (Teraziler - Yazıcı)  
Transponder kart okuyucular  
RS 232 Kabloları (Teraziler - ZEBRA Yazıcı)  
Antivibrasyon masaları  
Ağ kabloları (Teraziler - Ethernet)  
Display  
RS 232, RS 485 Kabloları  
Giriş/Çıkış kabloları  
Barkod okuyucu

Etiket Yazıcısı  
Tartım terminalleri için tutucular  
Klavye  
Fiş yazıcı  
F1 Kütle standardı - ayar odacısız silindirik ağırlıklar, setleri  
USB Kablolar (terazi-Epson yazıcı)  
Modülleri ek platformları  
Ek modüller  
RS 232 – USB Dönüştürücü  
Makaralı tabla versiyon

## Yazılım (Additional Fee)

• E2R Tartım [WX-010-0099]  
• Audit Trail Reader [WX-010-0186]  
• RADWAG Remote Desktop [WX-010-0107]  
• Terazî Editörü - EWAG 2.1 [WX-010-0173]

• RAD Key [WX-010-0005]  
• Etiket Editörü R02 [WX-010-0094]  
• R-Lab [WX-010-0080]  
• RADWAG Development Studio [WX-010-0104]

## Cihaz boyutları G x D x Y



H Platform

Scale type	A1	A2	B
HY10 H1.K	200	150	85 ±3
HY10 H2.K	250	300	103 ±3
HY10 H3.K	410	410	98 ±2
HY10 H4.K	500	500	155 ±5
HY10 H5.K	600	600	155 ±5
HY10 H6.K	800	800	135 ±5

dimensions in mm

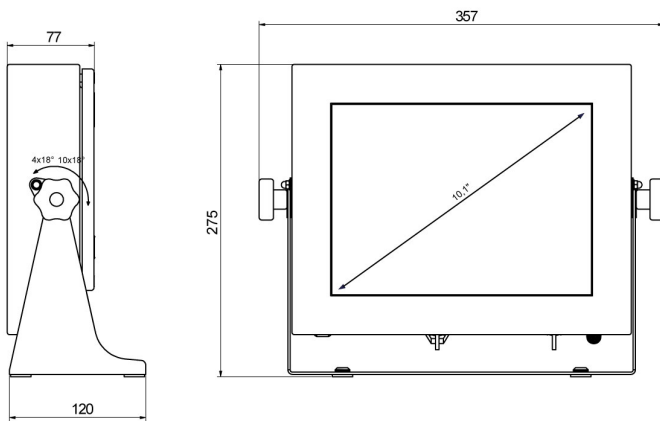

PUE HY10