



More information on the website
mirror.radwag.com/us/info,w1,Y68



















HY10.60.C2.K Multifunctional Scale

WP-116-0006



The drawings, photos and graphics used are for illustrative purposes only.

Functions

-  Dosing
-  Labelling
-  Plus/Minus Control
-  Percent Weighing
-  Totalizing
-  Parts counting
-  Peak hold
-  Formulation
-  Newton unit measurement
-  Statistics
-  Checkweighing
-  GLP Procedures
-  Animal weighing
-  Differential weighing
-  Replaceable unit
-  Statistical Quality Control
-  ALIBI Memory
-  Transactions

Datasheet

Metrological parameters	
Maximum capacity [Max]	60 kg
Minimum load	400 g
Readability [d]	20 g
Verification unit [e]	20 g

Metrological parameters	
Tare range	-60 kg
Max readability for non-verified scale	2 g
Adjustment	external
OIML Class	III
Physical parameters	
Display	10,1" graphic colour touchscreen
Cable length	2,5 m
Weighing pan dimensions	400x500 mm
Packaging dimensions W x D x H	620x720x440 mm
Net weight	16 kg
Gross weight	18 kg
Construction	
Protection class	IP 65 construction, IP 66 / 67 / 69 terminal
Communication interface	
Communication interface	2xRS232, 2xUSB-A, Ethernet, 4 IN / 4 OUT (digital)
Optional interfaces	module Wi-Fi 802.11 b/g/n, module Profibus (DP SLAVE), module RS485, module PROFINET (RJ45), analog output module (4-20mA, 0-20mA, 0-10V) , 12IN / 12OUT (IN – 5-24 VDC, OUT – max 30 VDC, 0,5 ADC)
Electrical parameters	
Power supply	100 – 240 V AC 50/60 Hz
Environmental conditions	
Operating temperature	-10 – +40 °C
Relative humidity	10% – 85% RH no condensation

* Wi-Fi® is a registered trademark of Wi-Fi® Alliance.



Additional fee for verification



Accessories (Additional Fee)

AP2-4 Current Loop Unit
 RS 232 cables (scale - printer)
 Transponder card readers
 RS 232 cables (scale - ZEBRA printer)
 Ethernet cables (scale - Ethernet)
 Displays
 RS 232, RS 485 cables
 IN/OUT Cables
 Barcode scanners
 Label Printers

Stands, wall mounting kits and mounting brackets
 Antivibration tables
 Keypad, external switches
 Receipt Printer
 F1 Mass Standard -
 knob weights without adjustment chamber, set
 USB cable (scale - printer)
 Additional Weighing platforms Module
 Additional modules
 RS 232 – USB Converter

Software (Additional Fee)

- E2R Weighing [WX-010-0099]
- Audit Trail Reader [WX-010-0186]

- RAD Key [WX-010-0005]
- Label Editor R02 [WX-010-0094]

Device dimensions W x D x H

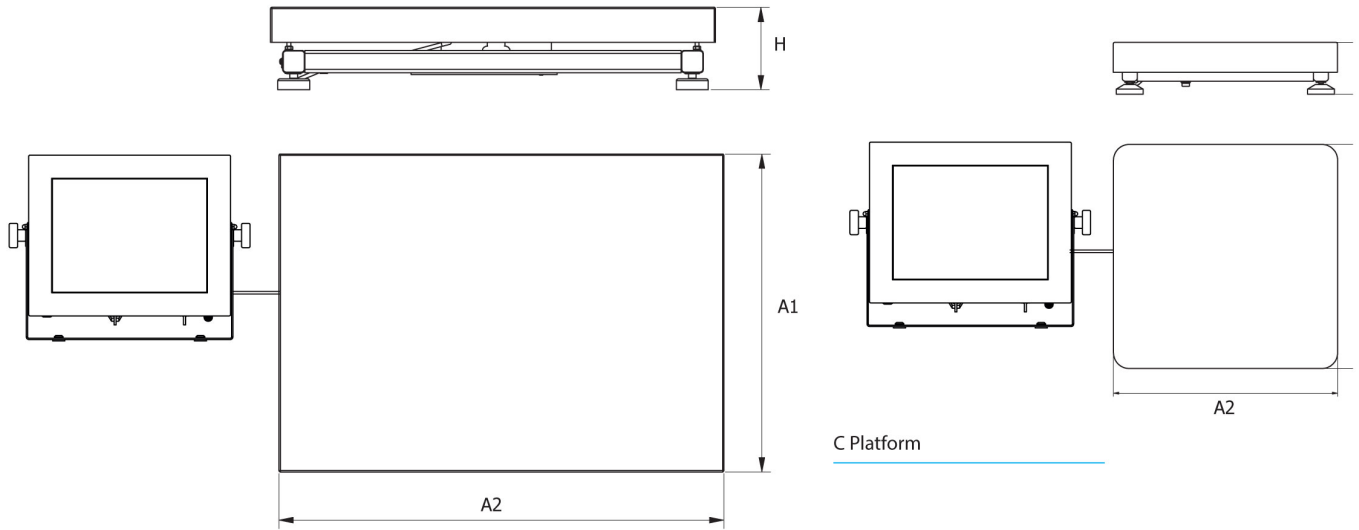

F1 Platform

C Platform

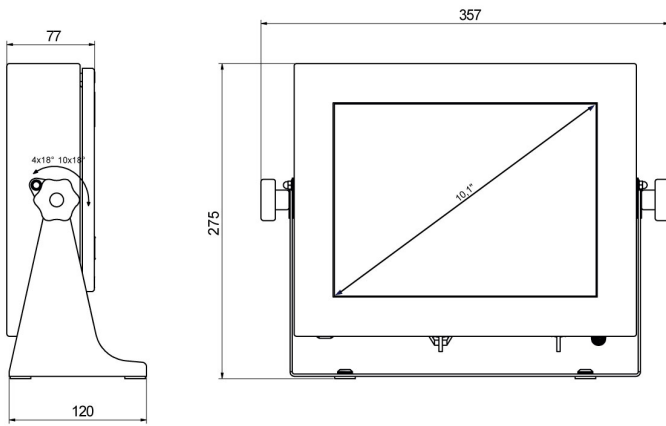

PUE HY10

Scale type	A1	A2	H
HY10.C2.K	400	500	103 ±3
HY10.C3.K	500	700	130 ±3
HY10.F1.K	300	300	70 ±3

dimensions in mm