



More information on the website  
[mirror.radwag.com/tr/info,w1,W3Y](http://mirror.radwag.com/tr/info,w1,W3Y)

## PSW/DUAL profesyonel Tartım masası

WX-001-0402



The drawings, photos and graphics used are for illustrative purposes only.

### Teknik Veriler

Fiziksel parametreler	
Kiti bileşenleri	Kalibrasyon için masa, Anti vibrasyon masası
Ambalaj boyutları G x D x Y	1140×820×986 mm
Net ağırlık	220 kg (masası 140 + taş 80)
Brüt ağırlık	252 kg
Uzunluk	1350 mm
En	750 mm
Yükseklik	1100 mm
Number of workstations	2



### İle uyumlu (Additional Fee)

XA 5Y.M.A.P pipetlerini kalibre etmek için Mikro Terazi  
MYA 5Y.P pipetlerini kalibre etmek için Mikro Terazi  
MYA 5Y.F filtreleri için Mikro Terazi

MYA 5Y Mikro Terazi  
AS R2 PLUS Analitik Teraziler  
XA 5Y.M Mikro Teraziler

AS X7 Analitik Teraziler  
XA 5Y.M.A Mikro Teraziler  
AS 5Y Analitik Teraziler  
Filtreleri için Analitik Terazi XA 5Y.F

UYA 5Y.KO Manuel kütle komparatör  
AS R1 PLUS Analitik Teraziler  
XA 5Y.M.A.S Stentler için Mikro Teraziler  
MAS.1.Y Modüller

## Cihaz boyutları G x D x Y

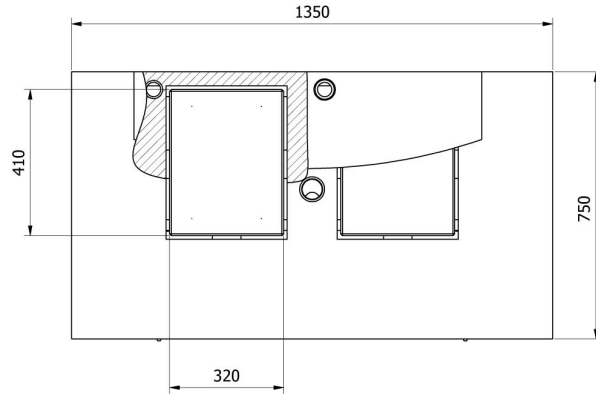
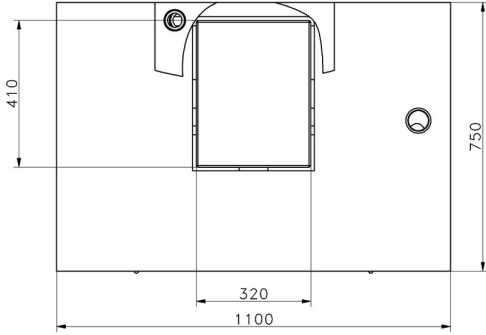
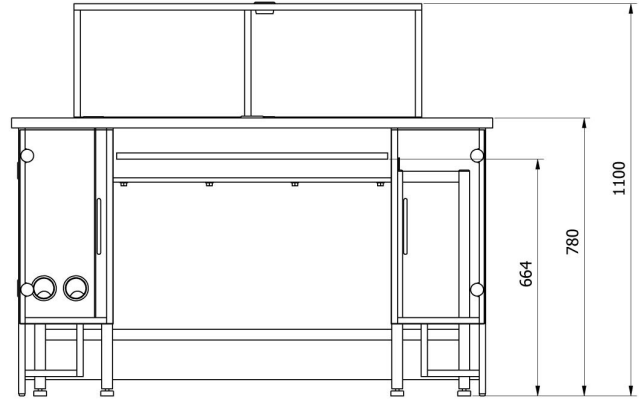
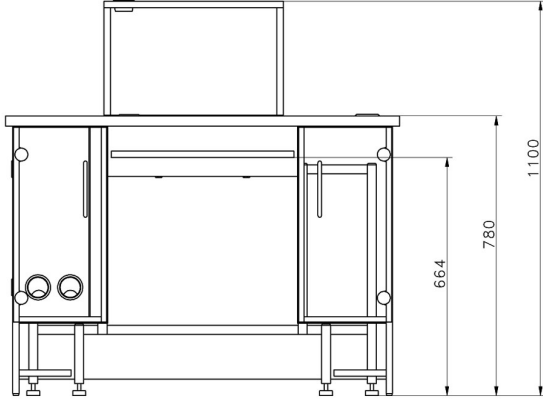

—SDKP

—SDKP DUAL