



More information on the website
mirror.radwag.com/us/info,w1,V4N















WLY 20/D2 Precision Balance

WL-219-0005



The drawings, photos and graphics used are for illustrative purposes only.

Functions

-  Dosing
-  Labelling
-  Plus/Minus Control
-  Percent Weighing
-  Totalizing
-  Parts counting
-  Peak hold
-  Formulation
-  Newton unit measurement
-  Statistics
-  Checkweighing
-  IR sensors
-  Animal weighing
-  Differential weighing
-  ALIBI Memory

Datasheet

Metrological parameters	
Maximum capacity [Max]	20 kg
Minimum load	-
Readability [d]	0,1 g
Verification unit [e]	-
Tare range	-20 kg
Repeatability	0,3 g

Metrological parameters	
Linearity	±0,3 g
Stabilization time	3 s
Adjustment	external
OIML Class	-
Physical parameters	
Leveling system	manual
Weighing pan dimensions	195×195 mm
Packaging dimensions W x D x H	530×310×150 mm
Net weight	2,7 kg
Gross weight	3,6 kg
Construction	
Protection class	IP 43
Communication interface	
Communication interface	2×RS232, 2×USB-A, Ethernet, 4 IN / 4 OUT (digital), Wi-Fi
Electrical parameters	
Power supply	Adapter: 100 – 240V AC 50/60Hz 1A; 15V DC 2,4A Balance: 10 – 28V DC 1A max
Environmental conditions	
Operating temperature	+15 – +30 °C
Storage temperature	-25 – +70 °C
Relative humidity	10% – 85% RH no condensation

Repeatability is expressed as a standard deviation from 10 weighing cycles.

Stabilization time depends on the ambient conditions and the dynamics of weighing pan loading; specified for FAST profile.

* Wi-Fi® is a registered trademark of Wi-Fi® Alliance.



Accessories (Additional Fee)

Antivibration tables
 Transponder card readers
 Power Adapters
 RS 232 cables (scale - printer)
 Cigarette lighter receptacle power supply cables
 Barcode scanners
 RS 232, RS 485 cables
 Label Printers
 Additional modules

Displays
 IN/OUT Cables
 Keypad, external switches
 Stands, wall mounting kits and mounting brackets
 Receipt Printer
 F1 Mass Standard -
 knob weights without adjustment chamber, set
 AP2-1 Current Loop Unit
 Additional Weighing platforms Module
 RS 232 – USB Converter

Software (Additional Fee)

- E2R Weighing [WX-010-0099]
- Audit Trail Reader [WX-010-0186]
- RADWAG Remote Desktop [WX-010-0107]
- RADWAG Development Studio [WX-010-0104]

- RAD Key [WX-010-0005]
- Label Editor R02 [WX-010-0094]
- Scale Editor - EWAG 2.1 [WX-010-0173]

Device dimensions W x D x H



F1 version

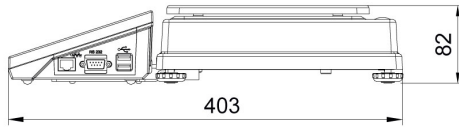

D2 version

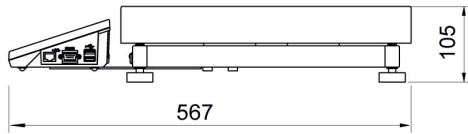
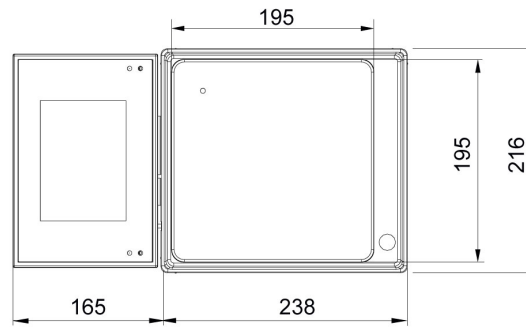

C2 version

