



More information on the website
mirror.radwag.com/es/info,w1,V26

Báscula impermeable H315.30.HR2.M

WP-124-0065





The drawings, photos and graphics used are for illustrative purposes only.

Funciones

 Control más/menos

 Desviaciones porcentuales

 Resumiendo pesajes

 Contar piezas

 Batería interna

 Cierre de la indicación máxima

 Medición en Newtons

 Pesar animales

Datos técnicos

Parámetros metrológicos

Maxima capacidad [Max]	30 kg
Minima capacidad	200 g
Legibilidad [d]	10 g
División de legalización [e]	10 g
Rango de tara	-30 kg
Legibilidad máxima para las balanzas no verificadas	1 g
Clase OIML	III

Parámetros físicos

Pantalla	4,3" LCD (con retroiluminación)
----------	---------------------------------

Parámetros físicos	
Dimensión de platillo	250×300 mm
Dimensiones de embalaje An x Pr x Al	560×310×270 mm
Masa neta	9 kg
Masa bruta	10,3 kg
Construcción	
Grado de protección	IP 66 / 67 / 69 construcción, IP 68 / 69 extensómetro, IP 66 / 67 / 69 terminal
Construcción	Acero inoxidable AISI316
Interface de comunicación	
Conectividad	RS232, USB
Interfaces opcionales	RS232 o RS485 o 4IN/4OUT o Ethernet o entradas analógica 4-20 mA
Parámetros electricos	
Alimentacion	100 – 240 V AC 50/60 Hz
Corriente de alimentación adicional	batería interna
Horas de trabajo con baterias	max 7h
Condiciones ambientales	
Temperatura de trabajo	-10 – +40 °C
Temperatura de almacenamiento	-25 – +70 °C
Humedad relativa de aire	10% – 85% RH sin condensación



Additional fee for verification



Accesorios (Additional Fee)

Cables RS 232 (Bacula a Impresora)
 Soportes con transportadores con rollos
 Mesas antivibratil
 Salidas del bucle de corriente AP2-3
 Pantallas
 Cables de corriente (Bacula a Ethernet)
 Cables RS 232, RS 485

Adaptadores de corriente
 Convertidor RS 232 a Ethernet
 Adaptadores USB
 Impresoras de recibos
 Cable USB (Bacula a Impresora)
 Soportes, brazos
 Convertidor RS 232 a USB

Programas (Additional Fee)

- RAD Key [WX-010-0005]
- Editor de Balanzas 2.1 [WX-010-0173]

- R-LAB [WX-010-0080]

Dimensiones de aparato An x Pr x Al

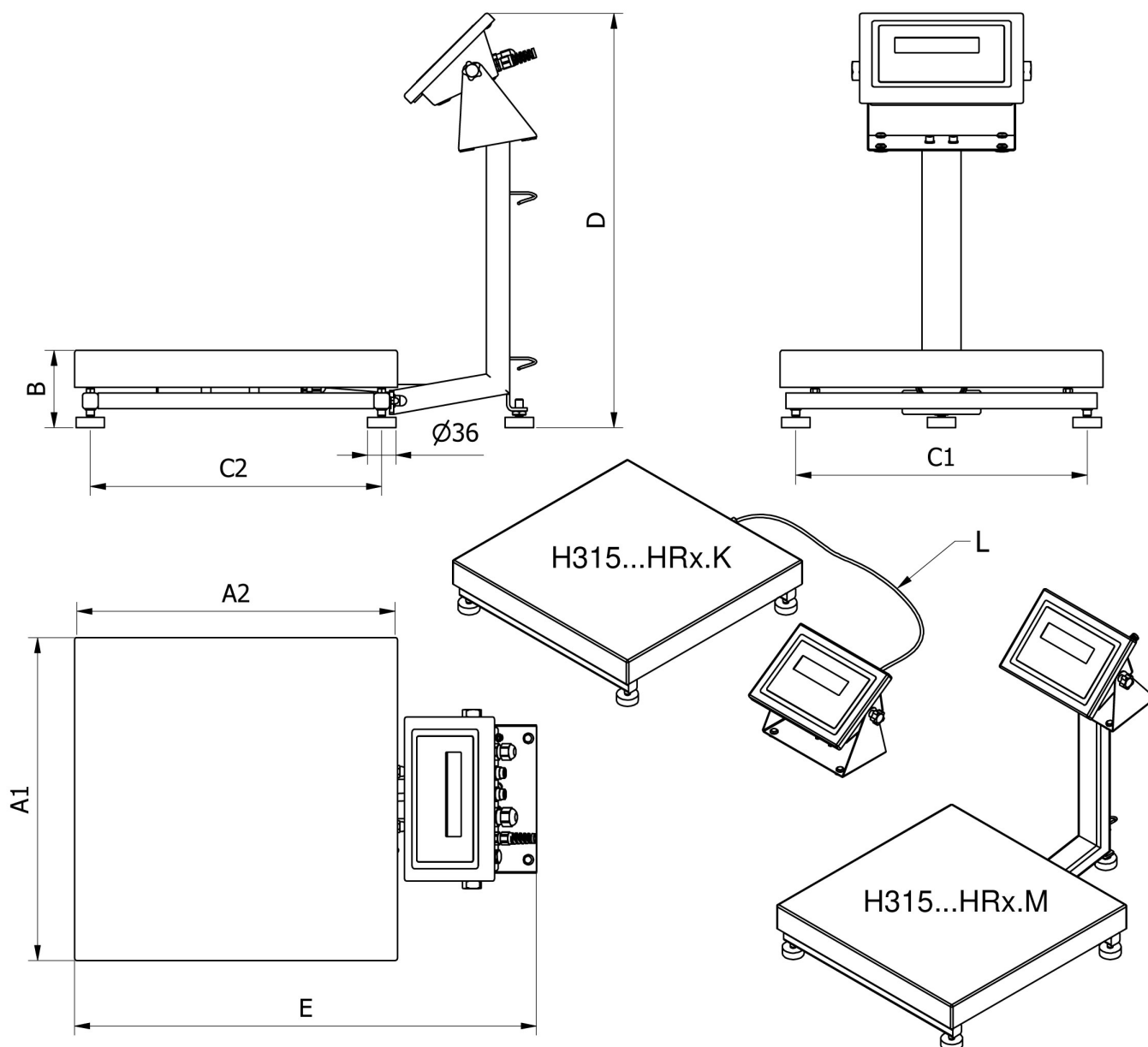

		A1	A2	B	C1	C2	D	E	L
H315...HR2.M	250 x 300	246	306	104 ± 3	208	268	~525	~483	
H315...HR2.K	250 x 300	246	306	104 ± 3	208	268	-	-	1,5m
H315...HR3.M	410 x 410	410	410	98 ± 2	370	370	~525	~587	
H315...HR3.K	410 x 410	410	410	98 ± 2	370	370	-	-	2,5m
H315...HR4.M	500 x 500	497	497	155 ± 5	400	400	~767	~650	
H315...HR4.K	500 x 500	497	497	155 ± 5	400	400	-	-	2,5m
H315...HR3/5.M	400 x 600	597	397	155 ± 5	500	300	~767	~550	
H315...HR3/5.K	400 x 600	597	397	155 ± 5	500	300	-	-	2,5m
H315...HR5.M	600 x 600	597	597	155 ± 5	500	500	~767	~750	
H315...HR5.K	600 x 600	597	597	155 ± 5	500	500	-	-	2,5m