























More information on the website
mirror.radwag.com/en/info,w1,UB8

WLC 2.X2 Precision Balance



The drawings, photos and graphics used are for illustrative purposes only.

Functions

-  Autotest
-  Dosing
-  Percent Weighing
-  Parts counting
-  Peak hold
-  Formulation
-  Newton unit measurement
-  Statistics
-  Checkweighing
-  IR sensors
-  Under-pan weighing
-  GLP Procedures
-  Animal weighing
-  Density determination
-  Ambient conditions monitoring
-  Replaceable unit
-  Statistical Quality Control
-  ALIBI Memory
-  Mass for titrator
-  Wi-Fi

Datasheet

Metrological parameters	
Maximum capacity [Max]	2 kg
Readability [d]	0.01 g
Verification unit [e]	-
Tare range	-2 kg

Metrological parameters	
Repeatability	0.015 g
Linearity	±0.03 g
Stabilization time	2 s
Adjustment	internal (automatic)
Physical parameters	
Leveling system	manual
Display	5" graphic color touchscreen
Delivery components	Balance, weighing pan, weighing pan shield, grounding bumper ×1, bumper ×3, power supply.
Weighing pan dimensions	195×195 mm
Packaging dimensions	430×270×190 mm
Net weight	2.2 kg
Gross weight	3.5 kg
Construction	
Protection class	IP 43
Components and software	
Database capacity	7
Communication interface	
Communication interface	2×RS232 ¹ , USB-A, USB-B, Ethernet, Wi-Fi
Electrical parameters	
Power supply	Adapter: 100 – 240V AC 50/60Hz 0.6A; 12V DC 1.2A Balance: 10 – 15VDC 0.6A max
Environmental conditions	
Operating temperature	+10 ÷ +40 °C

Repeatability is expressed as a standard deviation from 10 weighing cycles.

Stabilization time depends on the ambient conditions and the dynamics of weighing pan loading; specified for FAST profile.

¹ Barcode scanners, available as weighing instrument accessory, communicate with the instrument via RS232 interface exclusively.

* Wi-Fi® is a registered trademark of Wi-Fi® Alliance.



Accessories

Balance Storage Case
 Antivibration Tables
 Power Adapters
 RS 232 cables (scale - printer)
 Cigarette lighter receptacle power supply cables
 USB cable (scale - printer)
 Barcode scanners
 Under-pan weighing
 RS 232, RS 485 cables

Density determination KIT
 Displays
 Receipt Printer
 Protective cover for balances
 RS 232, RS 485 cables
 Additional modules
 Protective cover for balances
 RS 232 cables (scale - printer)
 RS 232 – RS 485 Converter

Software

- RAD Key [WX-010-0005]
- R-Lab [WX-010-0080]
- RADWAG Development Studio [WX-010-0104]

- Alibi Reader [WX-010-0114]
- Scale Editor 2.1 [WX-010-0173]

Device dimensions

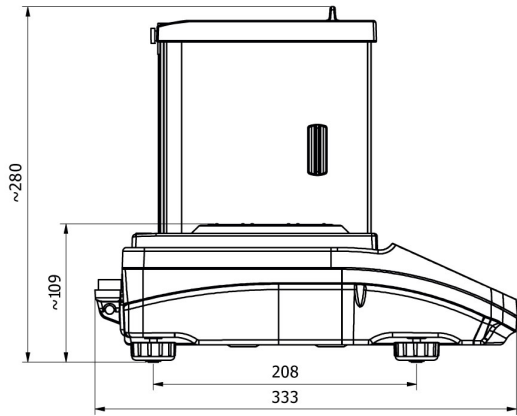

WLC X2, d = 0.001 mg

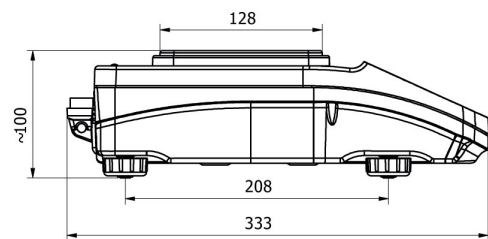
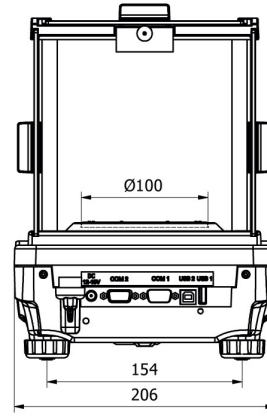

WLC X2, d = 0.01 mg

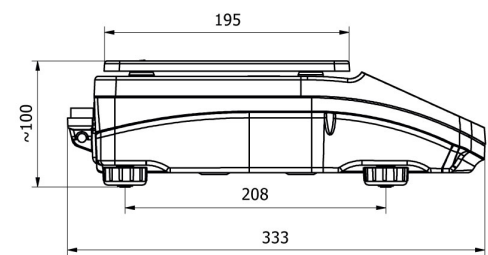
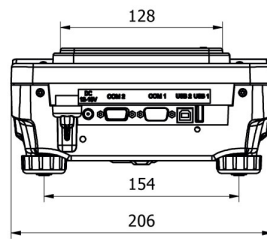

WLC X2, d = 0.1 mg

