



# HY10.60.C3.K Çok Fonksiyonlu Terazı



















WP-116-0058

More information on the website  
[mirror.radwag.com/tr/info,w1,T07](http://mirror.radwag.com/tr/info,w1,T07)



The drawings, photos and graphics used are for illustrative purposes only.

## Fonksiyonlar

-  Dosing
-  Labelling
-  Plus/Minus Control
-  Percent Weighing
-  Totalizing
-  Parts counting
-  Peak hold
-  Formulation
-  Newton unit measurement
-  Statistics
-  Checkweighing
-  GLP Procedures
-  Animal weighing
-  Differential weighing
-  Replaceable unit
-  Statistical Quality Control
-  ALIBI Memory
-  Transactions

## Teknik Veriler

| Metrolojik parametreler  |       |
|--------------------------|-------|
| Maksimum yük [Max]       | 60 kg |
| Minimum yük [Min]        | 400 g |
| Okuma için ğruluđu [d]   | 20 g  |
| Yasallařtırma birimi [e] | 20 g  |

| Metrolojik parametreler                                     |                                                                                                                                                                                               |
|-------------------------------------------------------------|-----------------------------------------------------------------------------------------------------------------------------------------------------------------------------------------------|
| Dara aralığı                                                | -60 kg                                                                                                                                                                                        |
| Ticari amaçla kullanılmayan terazi için maksimum hassasiyet | 2 g                                                                                                                                                                                           |
| Ayarlama                                                    | harici                                                                                                                                                                                        |
| OIML sınıfı                                                 | III                                                                                                                                                                                           |
| Fiziksel parametreler                                       |                                                                                                                                                                                               |
| Display                                                     | 10,1" grafik renkli dokunmatik                                                                                                                                                                |
| Kablo uzunluğu                                              | 2,5 m                                                                                                                                                                                         |
| Tartım kefesi boyutları                                     | 500x700 mm                                                                                                                                                                                    |
| Ambalaj boyutları G x D x Y                                 | 800x950x270 mm                                                                                                                                                                                |
| Net ağırlık                                                 | 25 kg                                                                                                                                                                                         |
| Brüt ağırlık                                                | 28 kg                                                                                                                                                                                         |
| Konstrüksiyon                                               |                                                                                                                                                                                               |
| IP Sınıfı                                                   | IP 65 konstrüksiyon, IP 66 / 67 / 69 terminal                                                                                                                                                 |
| Haberleşme arayüzler                                        |                                                                                                                                                                                               |
| Haberleşme arayüzü                                          | 2xRS232, 2xUSB-A, Ethernet, 4 IN / 4 OUT (dijital)                                                                                                                                            |
| Opsiyonel arayüzler                                         | modül Wi-Fi 802.11 b/g/n, modül Profibus (DP SLAVE), modül RS485, modül PROFINET (RJ45), analog çıkış modülü (4-20mA, 0-20mA, 0-10V), 12IN / 12OUT (IN – 5-24 VDC, OUT – max 30 VDC, 0,5 ADC) |
| Elektrik parametreleri                                      |                                                                                                                                                                                               |
| Güç kaynağı                                                 | 100 – 240 V AC 50/60 Hz                                                                                                                                                                       |
| Çevresel koşullar                                           |                                                                                                                                                                                               |
| Çalıştırma sıcaklığı                                        | -10 – +40 °C                                                                                                                                                                                  |
| Atmosferik nem                                              | 10% – 85% RH yoğunlaşma yok                                                                                                                                                                   |

\* Wi-Fi® is a registered trademark of Wi-Fi® Alliance.



Additional fee for verification



## Aksesuarlar (Additional Fee)

AP2-4 Güç döngüsü çıkışı  
RS 232 Kablolar (Teraziler - Yazıcı)  
Transponder kart okuyucular  
RS 232 Kabloları (Teraziler - ZEBRA Yazıcı)  
Ağ kabloları (Teraziler - Ethernet)  
Display  
RS 232, RS 485 Kabloları  
Giriş/Çıkış kabloları  
Barkod okuyucu

Etiket Yazıcısı  
Tartım terminalleri için tutucular  
Klavye  
Fiş yazıcı  
F1 Kütle standardı - ayar odacısız silindirik ağırlıklar, setleri  
USB Kablolar (terazi-Epson yazıcı)  
Modülleri ek platformları  
Ek modüller  
RS 232 – USB Dönüştürücü

## Yazılım (Additional Fee)

- E2R Tartım [WX-010-0099]
- Audit Trail Reader [WX-010-0186]
- RADWAG Remote Desktop [WX-010-0107]
- Terazi Editörü - EWAG 2.1 [WX-010-0173]

- RAD Key [WX-010-0005]
- Etiket Editörü R02 [WX-010-0094]
- R-Lab [WX-010-0080]
- RADWAG Development Studio [WX-010-0104]

# Cihaz boyutları G x D x Y

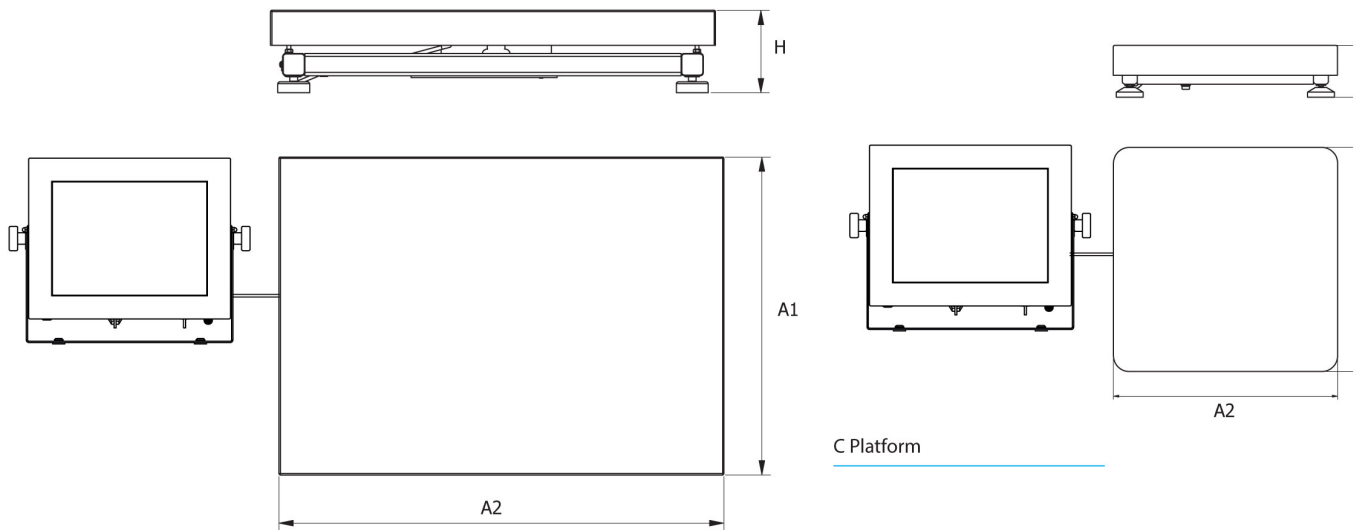

F1 Platform

C Platform

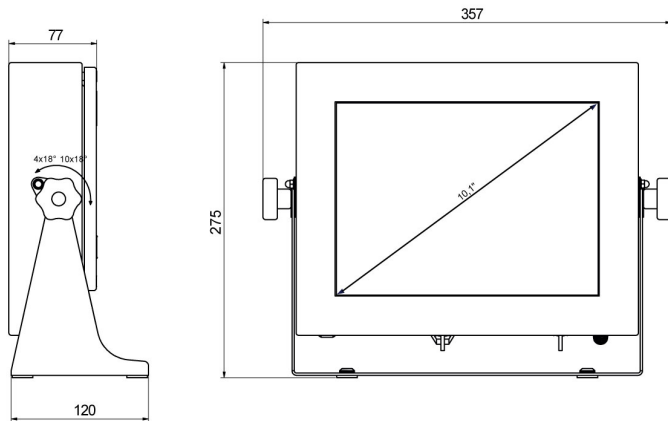

PUE HY10

| Scale type | A1  | A2  | H      |
|------------|-----|-----|--------|
| HY10.C2.K  | 400 | 500 | 103 ±3 |
| HY10.C3.K  | 500 | 700 | 130 ±3 |
| HY10.F1.K  | 300 | 300 | 70 ±3  |

dimensions in mm