



Balance multifonctionnelle HY10.150.H6.K

WP-116-0023

More information on the website
mirror.radwag.com/fr/info,w1,S2G



The drawings, photos and graphics used are for illustrative purposes only.

Fonctions

-  Dosing
-  Labelling
-  Plus/Minus Control
-  Percent Weighing
-  Totalizing
-  Parts counting
-  Peak hold
-  Formulation
-  Newton unit measurement
-  Statistics
-  Checkweighing
-  GLP Procedures
-  Animal weighing
-  Differential weighing
-  Replaceable unit
-  Statistical Quality Control
-  ALIBI Memory
-  Transactions

Paramètres Techniques

Paramètres métrologiques

Capacité maximale [Max]	150 kg
Capacité minimale [Min]	1 kg
Précision de lecture [d]	50 g
Échelon de légalisation [e]	50 g

Paramètres métrologiques	
Étendue de tare	-150 kg
Précision de lecture maximale pour les balances non vérifiées	10 g
Ajustage	externe
Classe de précision OIML	III
Paramètres physiques	
Afficheur	10,1" graphique couleurs écran tactile
Longueur de câble	2,5 m
Dimension du plateau	800x800 mm
Dimensions de colis L x P x H	820x1250x500 mm
Masse nette	43 kg
Masse brute	47 kg
Construction	
Degré de protection	IP 66 / 67 construction, IP 66 / 67 / 69 terminal
Interface de Communication	
Interface de Communication	2xRS232, 2xUSB-A, Ethernet, 4 IN / 4 OUT (numériques)
Interfaces optionnelles	module Wi-Fi 802.11 b/g/n, module Profibus (DP SLAVE), module RS485, module PROFINET (RJ45), module de sorties analogiques (4-20mA, 0-20mA, 0-10V) , 12IN / 12OUT (IN – 5-24 VDC, OUT – max 30 VDC, 0,5 ADC)
Paramètres électriques	
Alimentation	100 – 240 V AC 50/60 Hz
Conditions environnementales	
Température du travail	-10 – +40 °C
Humidité relative d'air	10% – 85% RH sans condensation

* Wi-Fi® is a registered trademark of Wi-Fi® Alliance.



Additional fee for verification



Accessoires (Additional Fee)

Sorties de boucle de courant AP2-4
 Câbles RS 232 (balance – imprimante)
 Lecteurs de cartes à transpondeur
 Câbles RS 232 (balance – imprimante ZEBRA)
 Câbles de réseau (balance – Ethernet)
 Afficheurs
 Câbles RS 232, RS 485
 Câbles d'Entrées/ de Sorties
 Lecteurs de code-barres

Imprimantes d'étiquettes
 Supports, Statifs, bras-supports
 Claviers, manipulateurs
 Imprimante de tickets de caisse
 Poids de classe F1 -
 cylindrique à bouton sans cavité d'ajustage, ensembles
 Câble USB (balance – imprimante)
 Modules de plateforme supplémentaires
 Modules complémentaires
 Convertisseur RS 232 – USB

Software (Additional Fee)

- E2R Pesages [WX-010-0099]
- Audit Trail Reader [WX-010-0186]

- RAD Key [WX-010-0005]
- Éditeur D'étiquettes R02 [WX-010-0094]

Dimensions d'appareil L x P x H



H Platform

Scale type	A1	A2	B
HY10 H1.K	200	150	85 ±3
HY10 H2.K	250	300	103 ±3
HY10 H3.K	410	410	98 ±2
HY10 H4.K	500	500	155 ±5
HY10 H5.K	600	600	155 ±5
HY10 H6.K	800	800	135 ±5

dimensions in mm

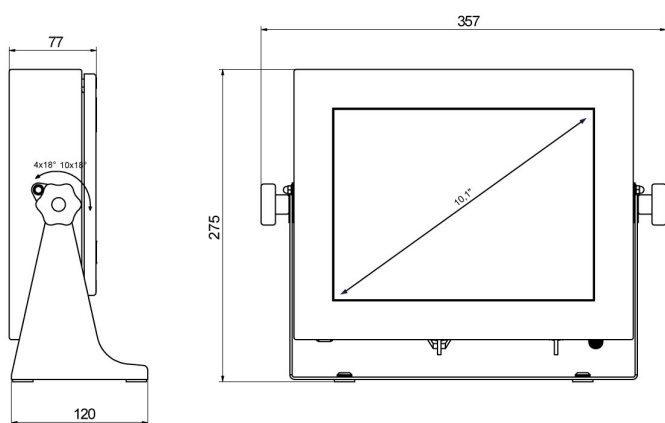

PUE HY10