



More information on the website  
[mirror.radwag.com/en/info,w1,S2G](http://mirror.radwag.com/en/info,w1,S2G)



















# HY10.150.H6.K Multifunctional Scale

WP-116-0023



The drawings, photos and graphics used are for illustrative purposes only.

## Functions

-  Dosing
-  Labelling
-  Plus/Minus Control
-  Percent Weighing
-  Totalizing
-  Parts counting
-  Peak hold
-  Formulation
-  Newton unit measurement
-  Statistics
-  Checkweighing
-  GLP Procedures
-  Animal weighing
-  Differential weighing
-  Replaceable unit
-  Statistical Quality Control
-  ALIBI Memory
-  Transactions

## Datasheet

Metrological parameters	
Maximum capacity [Max]	150 kg
Minimum load	1 kg
Readability [d]	50 g
Verification unit [e]	50 g

<b>Metrological parameters</b>	
Tare range	-150 kg
Max readability for non-verified scale	10 g
Adjustment	external
OIML Class	III
<b>Physical parameters</b>	
Display	10.1" graphic colour touchscreen
Cable length	2.5 m
Weighing pan dimensions	800×800 mm
Packaging dimensions W x D x H	820×1250×500 mm
Net weight	43 kg
Gross weight	47 kg
<b>Construction</b>	
Protection class	IP 66 / 67 construction, IP 66 / 67 / 69 terminal
<b>Communication interface</b>	
Communication interface	2×RS232, 2×USB-A, Ethernet, 4 IN / 4 OUT (digital)
Optional interfaces	module Wi-Fi 802.11 b/g/n, module Profibus (DP SLAVE), module RS485, module PROFINET (RJ45), analog output module (4-20mA, 0-20mA, 0-10V) , 12IN / 12OUT (IN – 5-24 VDC, OUT – max 30 VDC, 0.5 ADC)
<b>Electrical parameters</b>	
Power supply	100 – 240 V AC 50/60 Hz
<b>Environmental conditions</b>	
Operating temperature	-10 – +40 °C
Relative humidity	10% – 85% RH no condensation

\* Wi-Fi® is a registered trademark of Wi-Fi® Alliance.



Additional fee for verification



## Accessories (Additional Fee)

RS 232 cables (scale - printer)  
 Transponder card readers  
 RS 232 cables (scale - ZEBRA printer)  
 RS 232 cables (scale - Ethernet)  
 Displays  
 RS 232, RS 485 cables  
 IN/OUT Cables  
 Barcode scanners  
 Label Printers

Stands, wall mounting kits and mounting brackets  
 Keypad, external switches  
 Receipt Printer  
 F1 Mass Standard -  
 nob weights without adjustment chamber, set  
 USB cable (scale - printer)  
 Additional Weighing platforms Module  
 Additional modules  
 RS 232 – USB Converter

## Software (Additional Fee)

- E2R Weighing [WX-010-0099]
- Audit Trail Reader [WX-010-0186]
- RADWAG Remote Desktop [WX-010-0107]

- RAD Key [WX-010-0005]
- Label Editor R02 [WX-010-0094]
- R-Lab [WX-010-0080]

## Device dimensions W x D x H

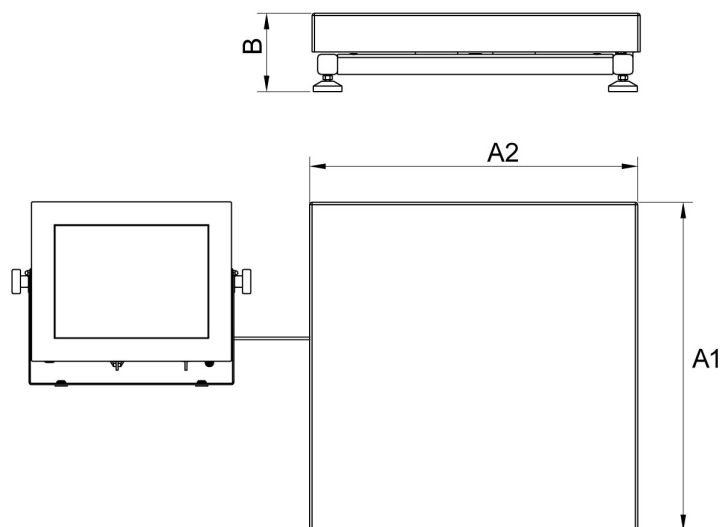

Scale type	A1	A2	B
HY10 H1.K	200	150	85 ±3
HY10 H2.K	250	300	103 ±3
HY10 H3.K	410	410	98 ±2
HY10 H4.K	500	500	155 ±5
HY10 H5.K	600	600	155 ±5
HY10 H6.K	800	800	135 ±5

dimensions in mm

H Platform

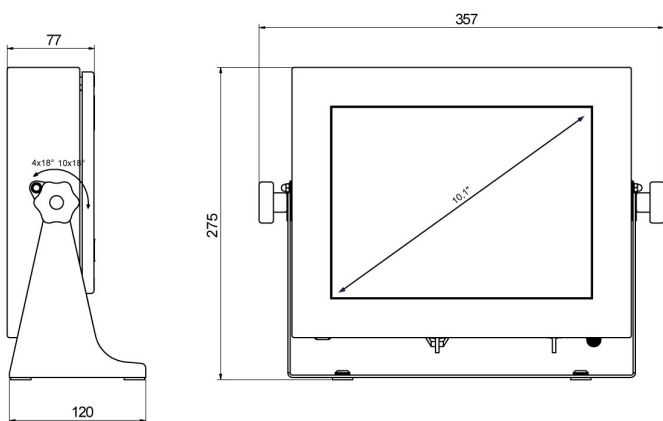

PUE HY10