



More information on the website
mirror.radwag.com/tr/info,w1,PD9

C315.15/30.F1.K Yük Hücreli Platform Terazi

WP-123-1008



The drawings, photos and graphics used are for illustrative purposes only.

Fonksiyonlar

 Plus/Minus Control

 Percent Weighing

 Totalizing

 Parts counting

 Internal battery

 Peak hold

 Newton unit
measurement

 GLP Procedures

 Animal weighing

 ALIBI Memory

Teknik Veriler

Metrolojik parametreler	
Maksimum yük [Max]	15 / 30 kg
Minimum yük [Min]	100 g
Okuma için ruluęu [d]	5 / 10 g
Yasallařtırma birimi [e]	5 / 10 g
Dara aralıęı	-30 kg
OIML sınıfı	III

Fiziksel parametreler	
Display	4,3" LCD (aydınlatma ile)
Kablo uzunluğu	1 m
Tartım kefesi boyutları	300×300 mm
Ambalaj boyutları G x D x Y	570×390×170 mm
Net ağırlık	5,2 kg
Brüt ağırlık	6 kg
Konstrüksiyon	
IP Sınıfı	IP 65 konstrüksiyon, IP 43 terminal
Konstrüksiyon	toz kaplı çelik St3S
Tartım kefesi	Paslanmaz çelik AISI304
Haberleşme arayüzler	
Haberleşme arayüzü	RS232
Opsiyonel arayüzler	RS232
Elektrik parametreleri	
Güç kaynağı	100 – 240 V AC 50/60 Hz + batarya
Maksimum güç tüketimi	5 W
Batarya ile çalışma süresi	max 8h
Çevresel koşullar	
Çalıştırma sıcaklığı	-10 – +40 °C
Depolama sıcaklığı	-10 – +50 °C
Atmosferik nem	10% – 85% RH yoğunlaşma yok
İndikatör	C315



Additional fee for verification



Aksesuarlar (Additional Fee)

Antivibrasyon masaları
Güç adaptörü
RS 232 Kablolar (Teraziler - Yazıcı)
Tartım terminalleri için tutucular
Çakmak prizine uygun besleme kabloları
Display
RS 232, RS 485 Kabloları

RS 232 – Ethernet Dönüştürücü
AP2-1 Güç döngüsü çıkışı
RS 232 – USB Dönüştürücü
Kablolar RS 232 (Teraziler - Yazıcı)
RS 232 – RS 485 Dönüştürücü
Fiş yazıcı

Yazılım (Additional Fee)

• RAD Key [WX-010-0005]
• Terazi Editörü - EWAG 2.1 [WX-010-0173]

• R-Lab [WX-010-0080]

Cihaz boyutları G x D x Y

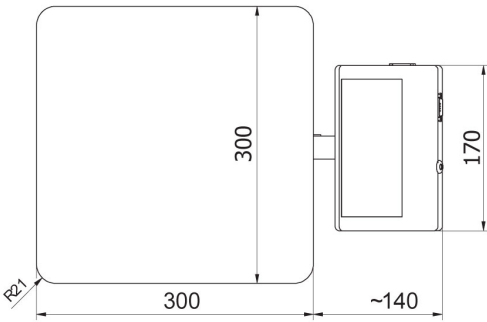

C315.F1.M

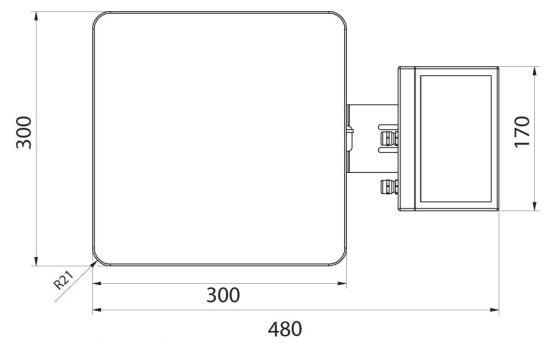
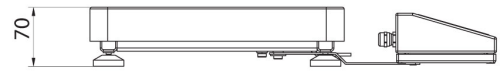

C315.F1.R

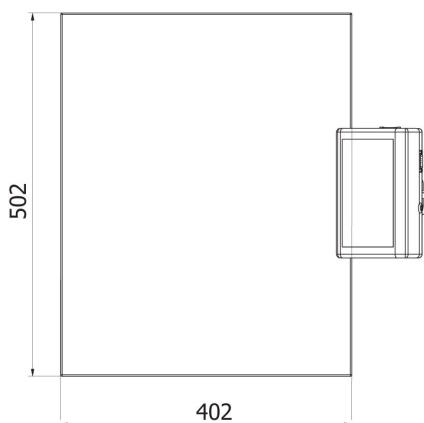
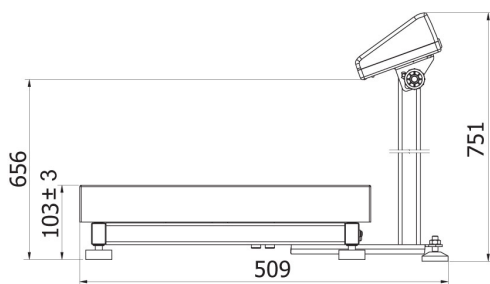

C315.C2.M

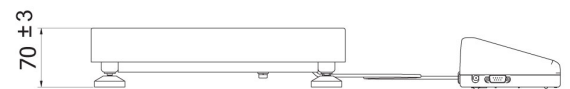

C315.C2.K