



HY10.3.F1.K Multifunctional Scale



















WP-116-0055

More information on the website
mirror.radwag.com/us/info,w1,OUQ



The drawings, photos and graphics used are for illustrative purposes only.

Functions

-  Dosing
-  Labelling
-  Plus/Minus Control
-  Percent Weighing
-  Totalizing
-  Parts counting
-  Peak hold
-  Formulation
-  Newton unit measurement
-  Statistics
-  Checkweighing
-  GLP Procedures
-  Animal weighing
-  Differential weighing
-  Replaceable unit
-  Statistical Quality Control
-  ALIBI Memory
-  Transactions

Datasheet

Maximum capacity [Max]	3 kg
Minimum load	20 g
Readability [d]	1 g
Verification unit [e]	1 g

Tare range	-3 kg
Max readability for non-verified scale	0,2 g
Adjustment	external
OIML Class	III
Physical parameters	
Display	10,1" graphic colour touchscreen
Cable length	1 m
Weighing pan dimensions	300×300 mm
Packaging dimensions W x D x H	390×570×390 mm
Net weight	10,3 kg
Gross weight	12,2 kg
Construction	
Protection class	IP 65 construction, IP 66 / 67 / 69 terminal
Communication interface	2×RS232, 2×USB-A, Ethernet, 4 IN / 4 OUT (digital)
Optional interfaces	module Wi-Fi 802.11 b/g/n, module Profibus (DP SLAVE), module RS485, module PROFINET (RJ45), analog output module (4-20mA, 0-20mA, 0-10V) , 12IN / 12OUT (IN – 5-24 VDC, OUT – max 30 VDC, 0,5 ADC)
Power supply	100 – 240 V AC 50/60 Hz
Operating temperature	-10 – +40 °C
Relative humidity	10% – 85% RH no condensation

* Wi-Fi® is a registered trademark of Wi-Fi® Alliance.



Additional fee for verification



Accessories (Additional Fee)

AP2-3 Current Loop Unit
 RS 232 cables (scale - printer)
 Transponder card readers
 RS 232 cables (scale - ZEBRA printer)
 Ethernet cables (scale - Ethernet)
 Displays
 RS 232, RS 485 cables
 IN/OUT Cables
 Barcode scanners
 Label Printers

Stands, wall mounting kits and mounting brackets
 Antivibration tables
 Keypad, external switches
 Receipt Printer
 F1 Mass Standard -
 knob weights without adjustment chamber, set
 USB cable (scale - printer)
 Additional Weighing platforms Module
 Additional modules
 RS 232 – USB Converter

Software (Additional Fee)

- E2R Weighing [WX-010-0099]
- Audit Trail Reader [WX-010-0186]
- RADWAG Remote Desktop [WX-010-0107]
- RADWAG Development Studio [WX-010-0104]

- RAD Key [WX-010-0005]
- Label Editor R02 [WX-010-0094]
- Scale Editor - EWAG 2.1 [WX-010-0173]

Device dimensions W x D x H

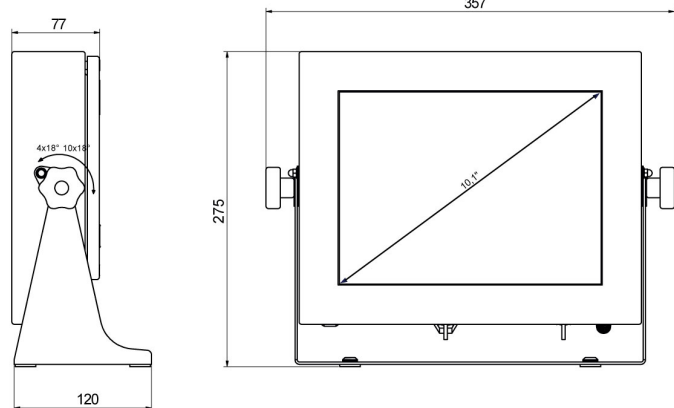
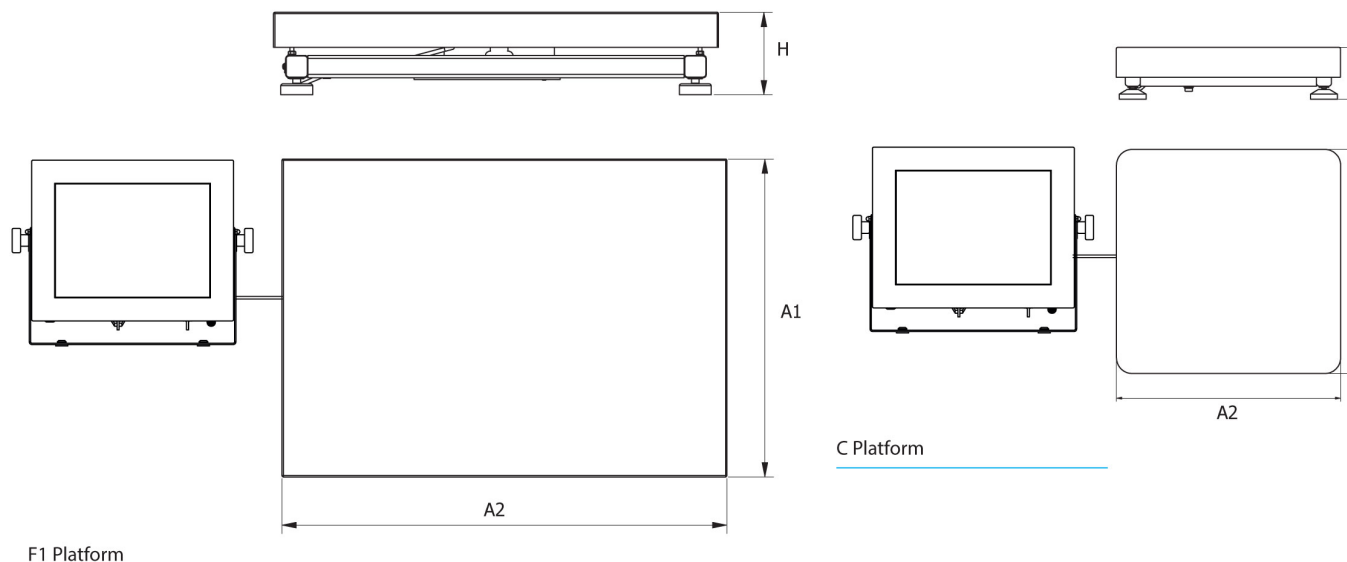

PUE HY10

Scale type	A1	A2	H
HY10.C2.K	400	500	103 ±3
HY10.C3.K	500	700	130 ±3
HY10.F1.K	300	300	70 ±3

dimensions in mm