



More information on the website
mirror.radwag.com/tr/info,w1,OLC

C32.1,5.D2 Çok Fonksiyonlu Terazı

WP-120-0006



The drawings, photos and graphics used are for illustrative purposes only.

Fonksiyonlar



Labelling



Plus/Minus Control



Percent Weighing



Totalizing



Parts counting



Newton unit
measurement



Statistics



IR sensors



GLP Procedures



Replaceable unit



ALIBI Memory

Teknik Veriler

Metrolojik parametreler

Maksimum yük [Max]	1,5 kg
Minimum yük [Min]	10 g
Okuma içinđruluđu [d]	0,5 g
Yasallaştırma birimi [e]	0,5 g
Dara aralıđı	-1,5 kg
Ticari amaçla kullanılmayan terazi için maksimum hassasiyet	0,05 g
OIML sınıfı	III

Fiziksel parametreler	
Display	5" grafik renkli
Kablo uzunluđu	1 m
Tartım kefesi boyutları	195x195 mm
Ambalaj boyutları G x D x Y	530x310x150 mm
Net ağırlık	3,4 kg
Brüt ağırlık	4,3 kg
Konstrüksiyon	
IP Sınıfı	IP 43
Dava	ABS plastik
Tartım kefesi	Paslanmaz çelik AISI304
Haberleşme arayüzler	
Haberleşme arayüzü	2xRS232, USB-A, USB-B, Ethernet, 4 IN / 4 OUT (dijital), Wi-Fi
Elektrik parametreleri	
Güç kaynağı	100 – 240 V AC 50/60 Hz
Maksimum güç tüketimi	10 W
Opsiyonel güç kaynağı	dahili batarya
Batarya ile çalışma süresi	5 saate kadar sürekli çalışma
Çevresel koşullar	
Çalıştırma sıcaklığı	-10 – +40 °C

* Ek ücret karşılığında isteğe bağlı donanım

* Wi-Fi® is a registered trademark of Wi-Fi® Alliance.



Additional fee for verification



Aksesuarlar (Additional Fee)

Display
Güç adaptörü
RS 232 Kablolar (Teraziler - Yazıcı)
Çakmak prizine uygun besleme kabloları
Barkod okuyucu
RS 232, RS 485 Kabloları
Etiket Yazıcısı

Antivibrasyon masaları
Klavye
Tartım terminalleri için tutucular
Ek modüller
Fiş yazıcı
AP2-1 Güç döngüsü çıkışı
Kablolar RS 232 (Teraziler - Yazıcı)

Yazılım (Additional Fee)

- E2R Tartım [WX-010-0099]
- Etiket Editörü R02 [WX-010-0094]
- R-Lab [WX-010-0080]
- RADWAG Development Studio [WX-010-0104]

- RAD Key [WX-010-0005]
- Alibi Okuyucu PC Yazılımı [WX-010-0114]
- Terazi Editörü - EWAG 2.1 [WX-010-0173]

Cihaz boyutları G x D x Y

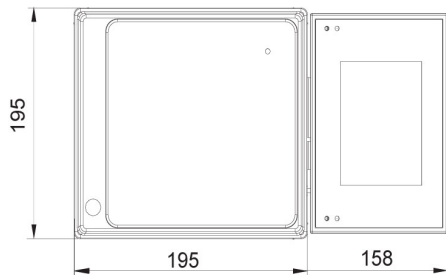
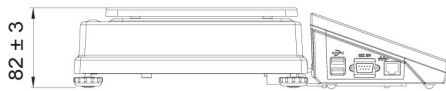

C32.D2

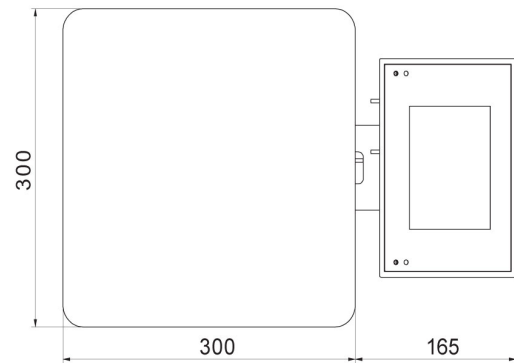
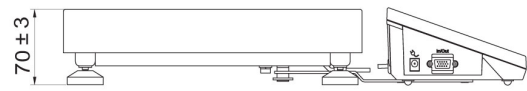

C32.F1.R

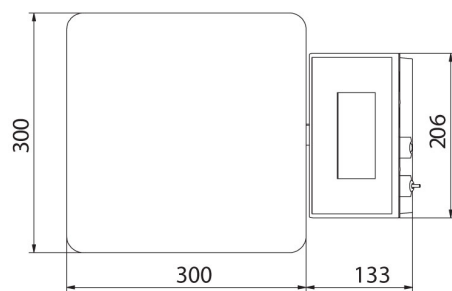
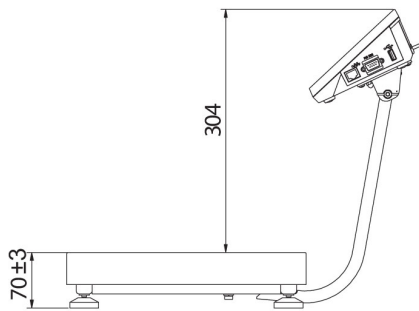

C32.F1.M

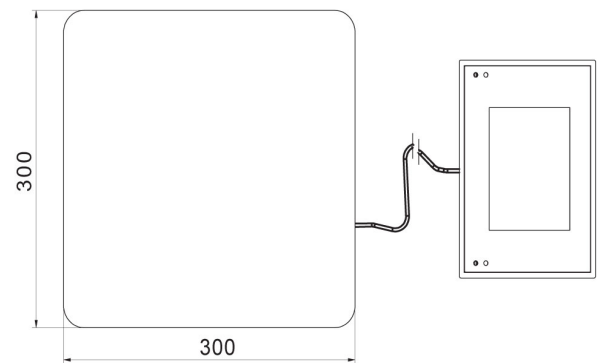
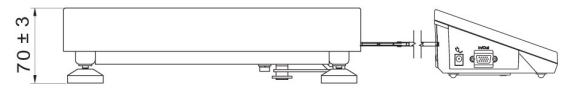

C32.F1.K