



More information on the website  
[mirror.radwag.com/de/info,w1,OLC](http://mirror.radwag.com/de/info,w1,OLC)

# Multifunktionswaage C32.1,5.D2

WP-120-0006



The drawings, photos and graphics used are for illustrative purposes only.

## Funktionen



Labelling



Plus/Minus Control



Percent Weighing



Totalizing



Parts counting



Newton unit measurement



Statistics



IR sensors



GLP Procedures



Replaceable unit



ALIBI Memory

## Technische Daten

Messtechnische Parameter	
Wägebereich [Max]	1,5 kg
Min. Belastung	10 g
Ablesbarkeit [d]	0,5 g
Eichwert [e]	0,5 g
Tarierbereich	-1,5 kg
Max Ablesbarkeit [d] bei nicht geeichter Waage	0,05 g
OIML-Klasse	III

Physikalische Parameter	
Display	5" grafisch farbiger
Kabellänge	1 m
Waagschale	195×195 mm
Verpackungsgröße B x T x H	530×310×150 mm
Nettogewicht	3,4 kg
Bruttogewicht	4,3 kg
Konstruktion	
Schutzart	IP 43
Gehäuse	ABS Kunststoff
Waageschale	Edelstahl AISI304
Kommunikationsschnittstellen	
Schnittstellen	2×RS232, USB-A, USB-B, Ethernet, 4 IN / 4 OUT (Digitalausgang), Wi-Fi
Elektrische Parameter	
Stromversorgung	100 – 240 V AC 50/60 Hz
Maximaler Leistungsaufnahme	10 W
Optionale Stromversorgung	interner Akkumulator
Akku-Betriebszeit	bis zu 5 Stunden Dauerbetrieb
Umgebungsbedingungen	
Umgebungstemperatur	-10 – +40 °C

\* - Option gegen Aufpreis

\* Wi-Fi® is a registered trademark of Wi-Fi® Alliance.



Additional fee for verification



## Zubehör (Additional Fee)

Displays  
 Netzteile  
 Kabel RS 232 (Waage – Drucker)  
 Anschlusskabel für Zigarettenanzünder  
 Barcode-Scanner  
 Kabel RS 232, RS 485  
 Etikettendrucker

Antivibrationstische  
 Tastaturen, Taster  
 Wandhalterung, Stativ  
 Zusätzliche Module  
 Thermische Drucker  
 Ausgang der Stromschnittstelle AP2-1

## Software (Additional Fee)

- E2R Wägung [WX-010-0099]
- Etiketten-Editor R02 [WX-010-0094]
- RLAB [WX-010-0080]
- RADWAG Development Studio [WX-010-0104]

- RAD Key [WX-010-0005]
- Alibi Reader [WX-010-0114]
- Scale Editor 2.1 [WX-010-0173]

# Abmessungen des Geräts B x T x H

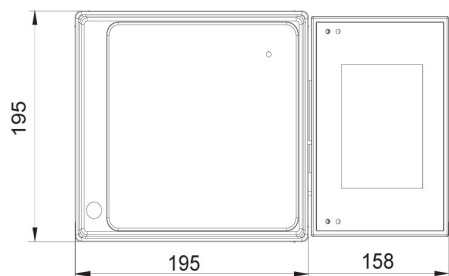

C32.D2

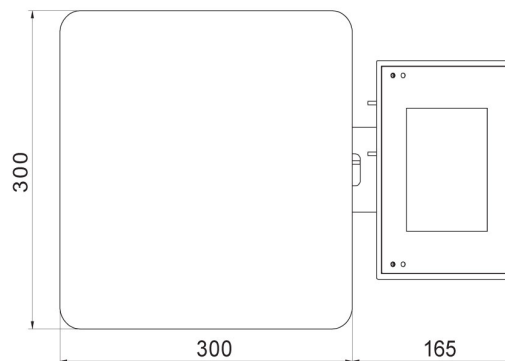
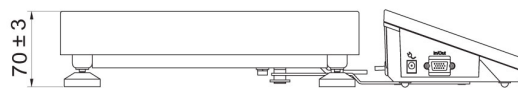

C32.F1.R

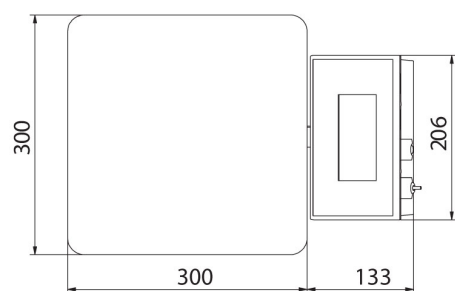
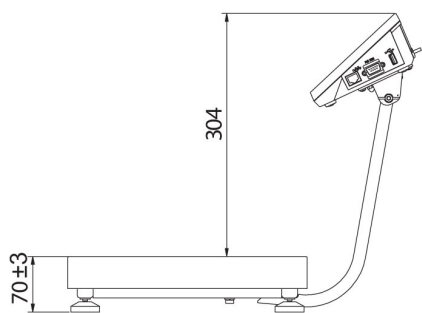

C32.F1.M

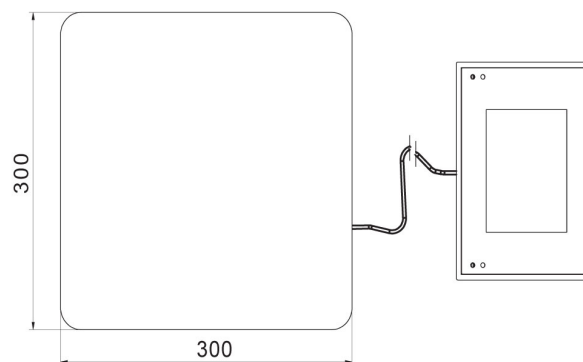
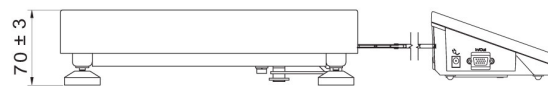

C32.F1.K