



More information on the website  
[mirror.radwag.com/br/info,w1,OLC](http://mirror.radwag.com/br/info,w1,OLC)

# Plataforma multifuncional C32.1,5.D2

WP-120-0006



The drawings, photos and graphics used are for illustrative purposes only.

## Funções



Labelling



Plus/Minus Control



Percent Weighing



Totalizing



Parts counting



Newton unit measurement



Statistics



IR sensors



GLP Procedures



Replaceable unit



ALIBI Memory

## Ficha Técnica

### Parâmetros metrológicos

Capacidade máxima [máx]	1,5 kg
Carga mínima	10 g
Resolução [d]	0,5 g
Unidade de verificação [e]	0,5 g
Faixa de tara	-1,5 kg
Resolução máxima para plataforma não verificada	0,05 g
Classe OIML	III

Parâmetros físicos	
Display	5" gráfico colorida
Comprimento até cabo	1 m
Dimensões até prato de pesagem	195×195 mm
Dimensões da embalagem L x P x A	530×310×150 mm
Peso líquido	3,4 kg
Peso bruto	4,3 kg
Construção	
Classe de proteção	IP 43
Carcaça	plástico ABS
Material até prato de pesagem	aço inoxidável AISI304
Interface de comunicação	
Interface de comunicação	2×RS232, USB-A, USB-B, Ethernet, 4 IN / 4 OUT (digital), Wi-Fi
Parâmetros elétricos	
Fonte de alimentação	100 – 240 V AC 50/60 Hz
Consumo de energia máx.	10 W
Fonte de alimentação opcional	bateria interna recarregável
Tempo de operação com baterias	tempo de operação até 5 h
Condições ambientais	
Temperatura de operação	-10 – +40 °C

\* Wi-Fi® is a registered trademark of Wi-Fi® Alliance.



Additional fee for verification



## Acessórios (Additional Fee)

Displays

Adaptadores de energia

Cabos de alimentação para acendedor de cigarro automotivo

!Leitores de código de barras

RS 232, RS 485 cabos

Impressoras de etiquetas

Mesas antivibração

Teclado, interruptores externos

Módulos adicionais

Impressora de recibos

Cabos RS 232 (plataforma - impressora)

## Software (Additional Fee)

• E2R Pesagem [WX-010-0099]

• Editor de etiquetas R02 [WX-010-0094]

• R-Lab [WX-010-0080]

• RAD Key [WX-010-0005]

• Leitor Alibi [WX-010-0114]

• RADWAG Development Studio [WX-010-0104]

## Dimensões do dispositivo L x P x A



C32.D2

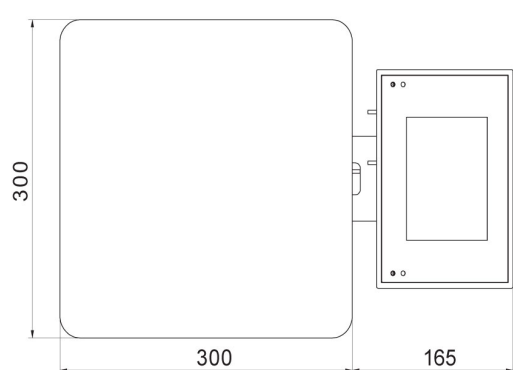

C32.F1.R



C32.F1.M

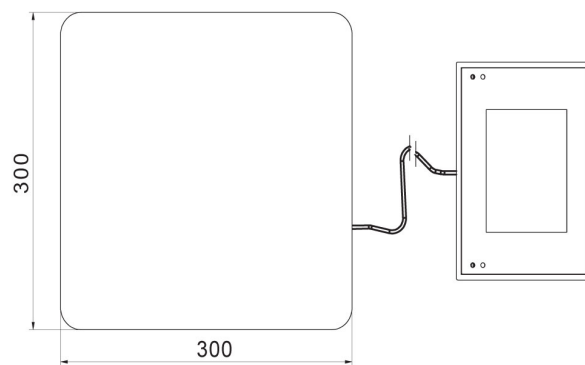
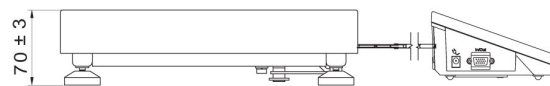

C32.F1.K