

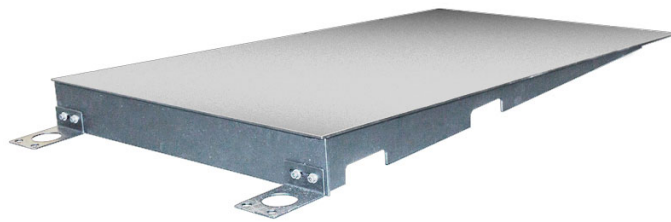

More information on the website  
[mirror.radwag.com/fr/info,w1,063](https://mirror.radwag.com/fr/info,w1,063)

# Rampe pour la balance H8 3000kg

WX-004-0177



The drawings, photos and graphics used are for illustrative purposes only.

## Paramètres Techniques

Construction	
Matière	Acier inoxydable
Paramètres physiques	
Dimensions de rampe	1200×1400 mm



## Compatible avec (Additional Fee)

Balance à plateformes inoxydables H315 4H

Balance multifonctionnelle à plateforme inoxydable encastrées HX7.4 H

# Dimensions d'appareil L x P x H



Ramps made of powder-coated steel



Ramps made of stainless steel