



More information on the website
mirror.radwag.com/es/info,w1,063

Rampa de balanza H8 3000kg

WX-004-0177



The drawings, photos and graphics used are for illustrative purposes only.

Datos tecnicos

Construcción	
Material	Acero inoxidable
Paramètros físicos	
Dimensión de plataforma de carga	1200×1400 mm



Trabaja con (Additional Fee)

Báscula de plataforma inoxidable H315 4H

Báscula multifuncionale de plataforma inoxidable HX7.4 H

Dimensiones de aparato An x Pr x Al



Ramps made of powder-coated steel

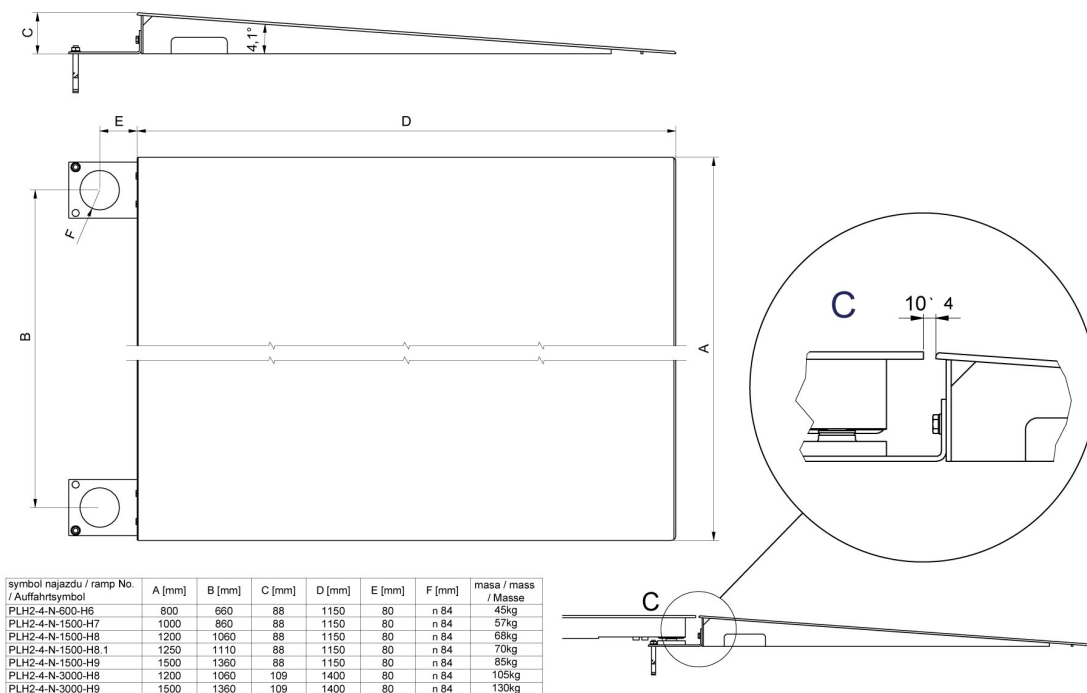

Ramps made of stainless steel