



More information on the website
mirror.radwag.com/it/info,w1,N00

Bilancia multifunzione C32.6.D2

WP-120-0007



The drawings, photos and graphics used are for illustrative purposes only.

Funzioni



Labelling



Plus/Minus Control



Percent Weighing



Totalizing



Parts counting



Newton unit measurement



Statistics



IR sensors



GLP Procedures



Replaceable unit



ALIBI Memory

Specifiche

| Parametri metrologici | |
|--|-------|
| Portata massima [Max] | 6 kg |
| Portata minima [Min] | 40 g |
| Divisione [d] | 2 g |
| Intervallo di verifica della bilancia [e] | 2 g |
| Campo di tara | -6 kg |
| Massima leggibilità per bilance non verificate | 0,2 g |
| Classe OIML | III |

| Parametri fisici | |
|--------------------------------|--|
| Display | 5" graphic colour |
| Lunghezza del cavo | 1 m |
| Dimensione piatto | 195×195 mm |
| Dimensioni del pacco L x P x A | 530×310×150 mm |
| Peso net | 3,4 kg |
| Peso lordo | 4,5 kg |
| Costruzione | |
| Punteggio IP | IP 43 |
| Struttura | ABS plastic |
| Materiale da pesata | Stainless steel AISI304 |
| Interfaccia di comunicazione | |
| Interfaccia | 2×RS232, USB-A, USB-B, Ethernet, 4 IN / 4 OUT (digital), Wi-Fi |
| Parametri elettrici | |
| Alimentatore | 100 – 240 V AC 50/60 Hz |
| Massimo assorbimento elettrico | 10 W |
| Alimentatore opzionale | internal rechargeable battery |
| Tempo operativo delle batterie | operation time up to 5 h |
| Environmental conditions | |
| Ambiente di lavoro | -10 – +40 °C |

* Equipaggiamento opzionale a pagamento

* Wi-Fi® is a registered trademark of Wi-Fi® Alliance.



Additional fee for verification



Accessori (Additional Fee)

Display
Alimentatore
Cavo seriale RS 232 (connessione bilance - Stampanti)
Cavo di alimentazione con spina per accendisigari
Lettore di codici a barre
Cavo seriale RS 232, RS 485
stampanti per etichette

Tavoli antivibranti
Tastiera, interruttori esterni
Supporto, set di montaggio a muro e braccetti di montaggio
Moduli aggiuntivi
Stampanti di ricevuata
AP2-1 Modulo di conversione analogica

Software (Additional Fee)

- E2R Weighing [WX-010-0099]
- Editore di etichette R02 [WX-010-0094]
- R-LAB [WX-010-0080]
- Software „Development Studio“ RADWAG [WX-010-0104]

- RAD Key [WX-010-0005]
- „Alibi Reader“ PC Software [WX-010-0114]
- Editore per sistemi di pesatura 2.1 [WX-010-0173]

Device dimensions L x P x A

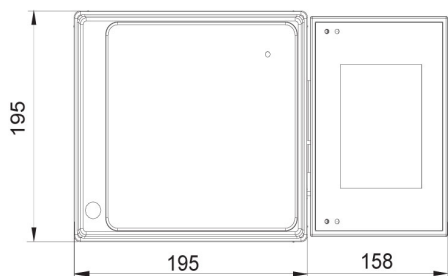
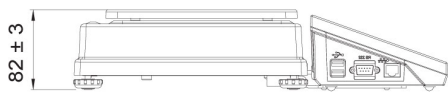

C32.D2

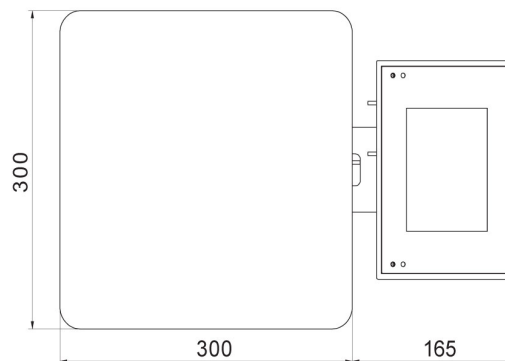
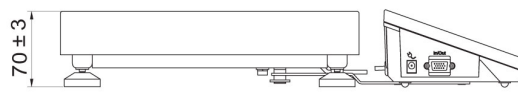

C32.F1.R

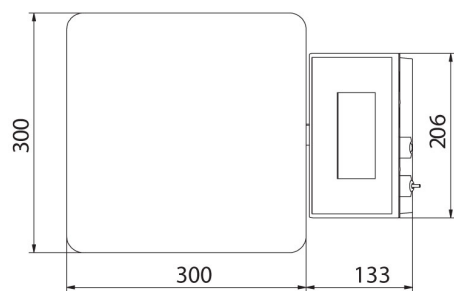
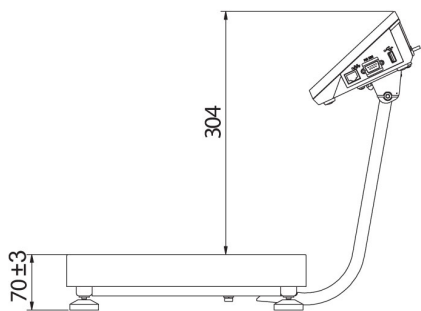

C32.F1.M

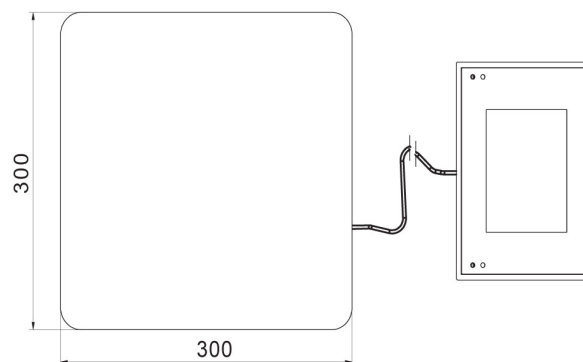
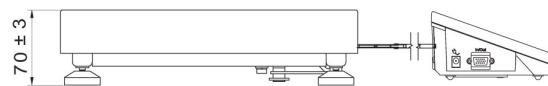

C32.F1.K