



More information on the website  
[mirror.radwag.com/fr/info,w1,LCR](http://mirror.radwag.com/fr/info,w1,LCR)

# Balance mono capteur C315.60.C2.M

WP-123-0022





The drawings, photos and graphics used are for illustrative purposes only.

## Fonctions

 Plus/Minus Control

 Percent Weighing

 Totalizing

 Parts counting

 Internal battery

 Peak hold

 Newton unit measurement

 GLP Procedures

 Animal weighing

 ALIBI Memory

## Paramètres Techniques

### Paramètres métrologiques

Capacité maximale [Max]	60 kg
Capacité minimale [Min]	400 g
Précision de lecture [d]	20 g
Échelon de légalisation [e]	20 g
Étendue de tare	-60 kg
Précision de lecture maximale pour les balances non vérifiées	2 g
Classe de précision OIML	III

<b>Paramètres physiques</b>	
Afficheur	4,3" LCD (rétro-éclairé)
Dimension du plateau	400×500 mm
Dimensions de colis L x P x H	720×620×210 mm
Masse nette	13,5 kg
Masse brute	15 kg
<b>Construction</b>	
Degré de protection	IP 65 construction, IP 43 terminal
Construction	acier pulvériséacier St3S
Matériel du plateau	Acier inoxydable AISI304
<b>Interface de Communication</b>	
Interface de Communication	RS232
Interfaces optionnelles	RS232
<b>Paramètres électriques</b>	
Alimentation	100 – 240 V AC 50/60 Hz + accumulateur
Prise de courant maximale	5 W
Temps de travail avec l'alimentation d'accumulateur	max 8h
<b>Conditions environnementales</b>	
Température du travail	-10 – +40 °C
Température de stockage	-10 – +50 °C
Humidité relative d'air	10% – 85% RH sans condensation
Terminal	C315



Additional fee for verification



## Accessoires (Additional Fee)

Tables antivibratoires  
Alimentateurs  
Câbles RS 232 (balance – imprimante)  
Câbles d'alimentation de cigare-allume  
Afficheurs  
Câbles RS 232, RS 485

Convertisseur RS 232 – Ethernet  
Sorties de boucle de courant AP2-1  
Convertisseur RS 232 – USB  
Convertisseur RS 232 – RS 485  
Imprimante de tickets de caisse  
Supports, Statifs, bras-supports

## Software (Additional Fee)

• RAD Key [WX-010-0005]  
• Éditeur de Balances 2.1 [WX-010-0173]

• R-LAB [WX-010-0080]

# Dimensions d'appareil L x P x H

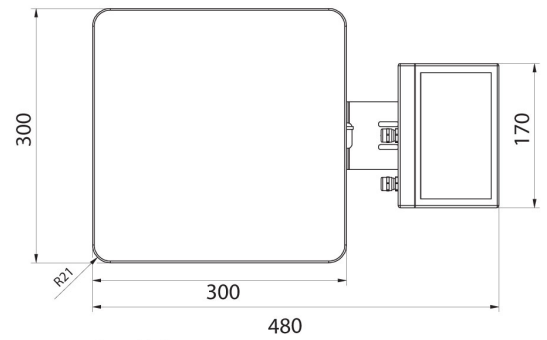
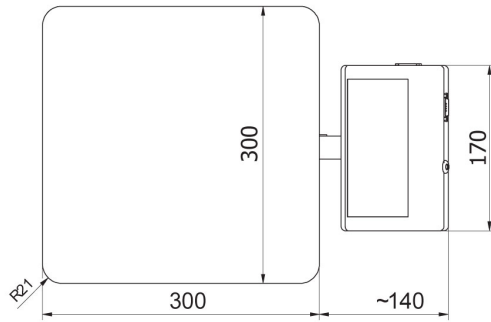
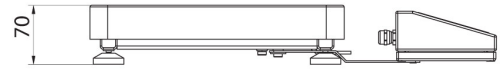
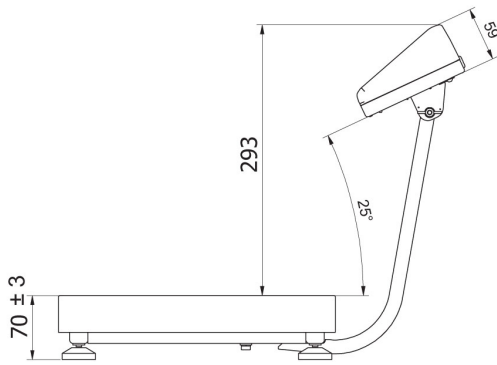

C315.F1.M

C315.F1.R

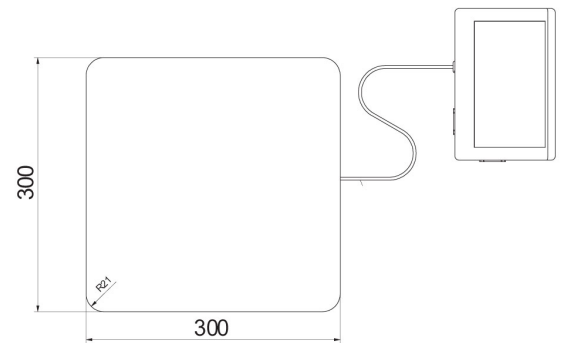
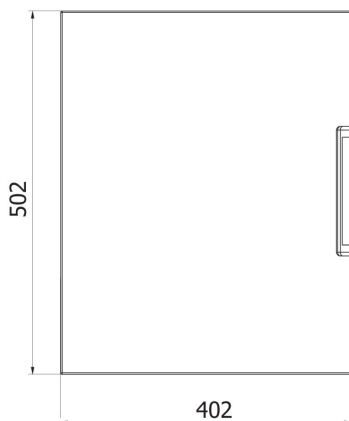
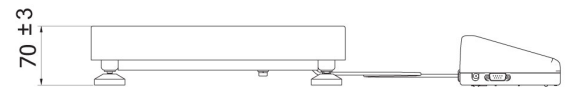
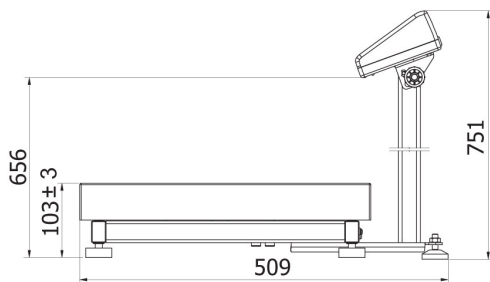

C315.C2.M

C315.C2.K