



More information on the website
mirror.radwag.com/it/info,w1,JNX

Piattaforma PL/4N/300/H2

WX-009-0184



The drawings, photos and graphics used are for illustrative purposes only.

Specifiche

Parametri metrologici	
Portata massima [Max]	300 kg
Costruzione	
Punteggio IP	IP 66 / 69
Costruzione	Stainless steel AISI304
Materiale da pesata	Stainless steel AISI304
Parametri fisici	
Dimensione piatto	1100×1200 mm
Altezza della piattaforma	77 mm



Accessori (Additional Fee)

Terminale di pesata PUE 5

Terminale di pesata PUE 7.1

Device dimensions L x P x A

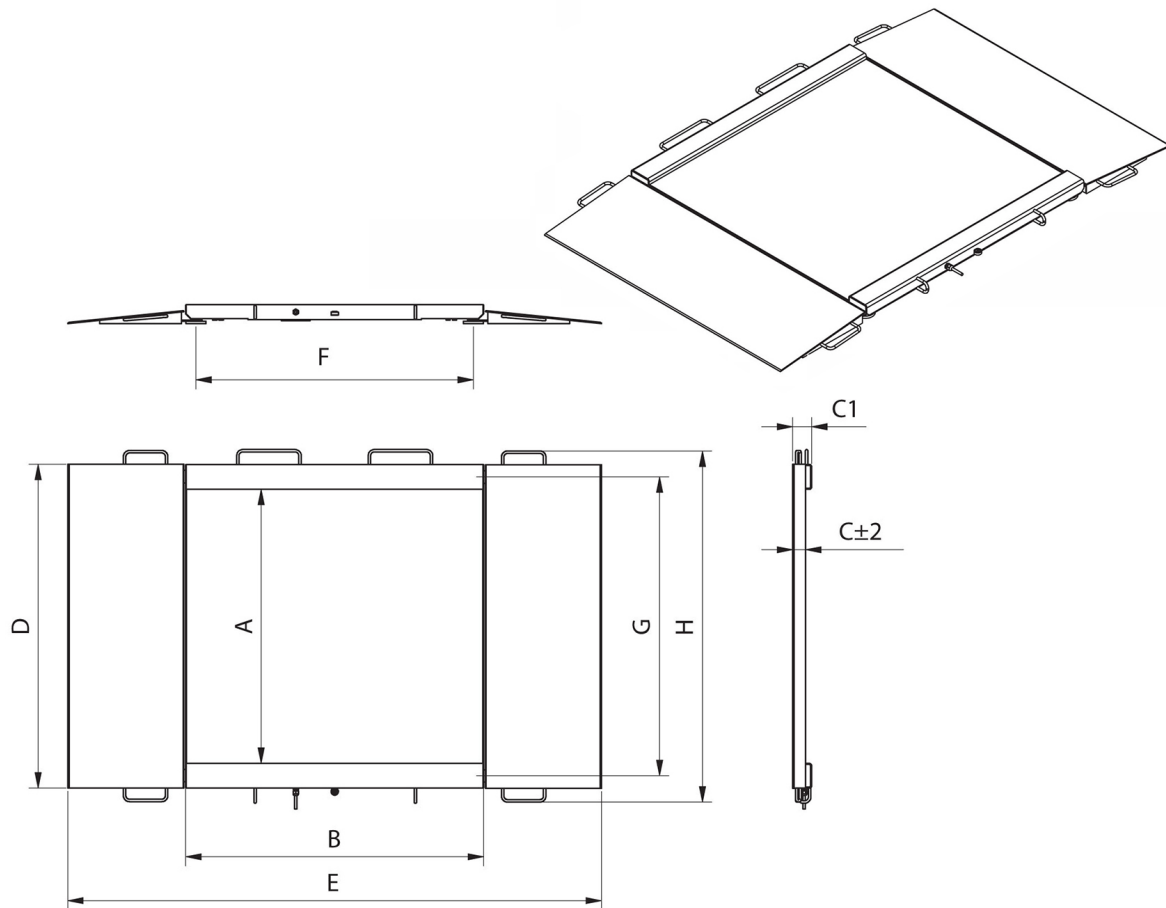

Model	Max	A	B	C	C1	D	E	F	G	H
PL/4N/150/H1	150 kg	840	860	45,5	76	1040	1710	778	940	1170
PL/4N/300/H1	300 kg	840	860	45,5	76	1040	1710	778	940	1170
PL/4N/600/H1	600 kg	840	860	45,5	76	1040	1710	778	940	1170
PL/4N/150/H2	1500 kg	1100	1200	45,5	76	1300	2050	1118	1200	1430
PL/4N/300/H2	300 kg	1100	1200	45,5	76	1300	2050	1118	1200	1430
PL/4N/600/H2	600 kg	1100	1200	45,5	76	1300	2050	1118	1200	1430
PL/4N/1500/H2	1500 kg	1100	1200	52,5	76	1300	2150	1118	1200	1430
PL/4N/300/H3	300 kg	1200	1500	45,5	76	1400	2350	1418	1300	1530
PL/4N/600/H3	600 kg	1200	1500	45,5	76	1400	2350	1418	1300	1530
PL/4N/1500/H3	1500 kg	1200	1500	52,5	76	1400	2450	1418	1300	1530
PL/4N/300/H4	300 kg	1500	1500	52,5	76	1700	2450	1418	1600	1830
PL/4N/600/H4	600 kg	1500	1500	52,5	76	1700	2450	1418	1600	1830
PL/4N/1500/H4	1500 kg	1500	1500	52,5	76	1700	2450	1418	1600	1830