



More information on the website
mirror.radwag.com/tr/info,w1,J2L

C315.15.F1.M Yük Hücreli Platform Terazisi

WP-123-0010



The drawings, photos and graphics used are for illustrative purposes only.

Fonksiyonlar

 Plus/Minus Control

 Percent Weighing

 Totalizing

 Parts counting

 Internal battery

 Peak hold

 Newton unit measurement

 GLP Procedures

 Animal weighing

 ALIBI Memory

Teknik Veriler

Metrolojik parametreler

Maksimum yük [Max]	15 kg
Minimum yük [Min]	100 g
Okuma için doğruluğu [d]	5 g
Yasallaştırma birimi [e]	5 g
Dara aralığı	-15 kg
Ticari amaçla kullanılmayan terazi için maksimum hassasiyet	0,5 g
OIML sınıfı	III

Fiziksel parametreler	
Display	4,3" LCD (aydınlatma ile)
Tartım kefesi boyutları	300×300 mm
Ambalaj boyutları G x D x Y	570×390×170 mm
Net ağırlık	4,8 kg
Brüt ağırlık	6,2 kg
Konstrüksiyon	
IP Sınıfı	IP 65 konstrüksiyon, IP 43 terminal
Konstrüksiyon	toz kaplı çelik St3S
Tartım kefesi	Paslanmaz çelik AISI304
Haberleşme arayüzler	
Haberleşme arayüzü	RS232
Opsiyonel arayüzler	RS232
Elektrik parametreleri	
Güç kaynağı	100 – 240 V AC 50/60 Hz + batarya
Maksimum güç tüketimi	5 W
Batarya ile çalışma süresi	max 8h
Çevresel koşullar	
Çalıştırma sıcaklığı	-10 – +40 °C
Depolama sıcaklığı	-10 – +50 °C
Atmosferik nem	10% – 85% RH yoğunlaşma yok
İndikatör	C315



Additional fee for verification



Aksesuarlar (Additional Fee)

Antivibrasyon masaları
Güç adaptörü
RS 232 Kablolar (Teraziler - Yazıcı)
Çakmak prizine uygun besleme kabloları
Display
RS 232, RS 485 Kabloları
RS 232 – Ethernet Dönüştürücü

AP2-1 Güç döngüsü çıkışı
RS 232 – USB Dönüştürücü
Kablolar RS 232 (Teraziler - Yazıcı)
RS 232 – RS 485 Dönüştürücü
Fiş yazıcı
Tartım terminalleri için tutucular

Yazılım (Additional Fee)

• RAD Key [WX-010-0005]
• Terazi Editörü - EWAG 2.1 [WX-010-0173]

• R-Lab [WX-010-0080]

Cihaz boyutları G x D x Y

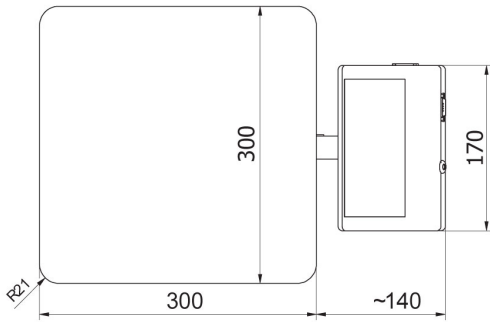

C315.F1.M

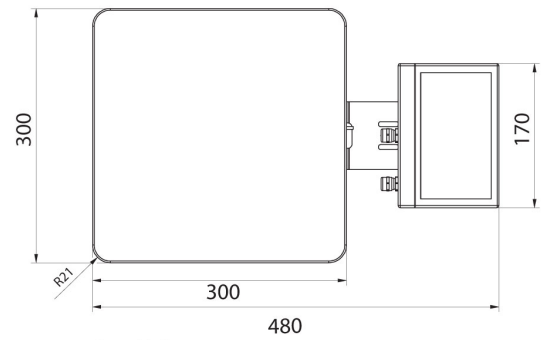

C315.F1.R

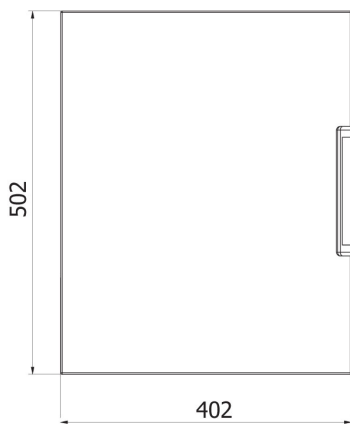

C315.C2.M

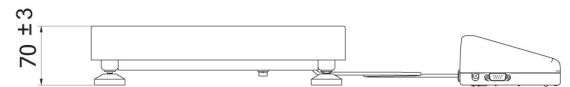

C315.C2.K