



More information on the website  
[mirror.radwag.com/br/info,w1,l50](http://mirror.radwag.com/br/info,w1,l50)

# Plataforma de pesagem C315.15.F1.R

WP-123-0012



The drawings, photos and graphics used are for illustrative purposes only.

## Funções

 Plus/Minus Control

 Percent Weighing

 Totalizing

 Parts counting

 Internal battery

 Peak hold

 Newton unit measurement

 GLP Procedures

 Animal weighing

 ALIBI Memory

## Ficha Técnica

### Parâmetros metrológicos

Capacidade máxima [máx]	15 kg
Carga mínima	100 g
Resolução [d]	5 g
Unidade de verificação [e]	5 g
Faixa de tara	-15 kg
Resolução máxima para plataforma não verificada	0,5 g
Classe OIML	III

Parâmetros físicos	
Display	4,3" LCD (retroiluminado)
Dimensões até prato de pesagem	300×300 mm
Dimensões da embalagem L x P x A	570×390×170 mm
Peso líquido	5,2 kg
Peso bruto	5,5 kg
Construção	
Classe de proteção	IP 65 construção, IP 43 terminal
Construção	aço carbono St3S
Material até prato de pesagem	aço inoxidável AISI304
Interface de comunicação	
Interface de comunicação	RS232
Parâmetros elétricos	
Fonte de alimentação	100 – 240 V AC 50/60 Hz e bateria
Consumo de energia máx.	5 W
Tempo de operação com baterias	max 8h
Condições ambientais	
Temperatura de operação	-10 – +40 °C
Temperatura de armazenamento	-10 – +50 °C
Umidade relativa	10% – 85% RH sem condensação
Indicador	C315



Additional fee for verification



## Acessórios (Additional Fee)

Mesas antivibração  
 Adaptadores de energia  
 Cabos de alimentação para acendedor de cigarro automotivo  
 Displays  
 RS 232, RS 485 cabos

Conversor RS 232 – Ethernet  
 RS 232 – Conversor USB  
 Cabos RS 232 (plataforma - impressora)  
 Conversor RS 232 – RS 485  
 Impressora de recibos

## Software (Additional Fee)

• RAD Key [WX-010-0005]

• R-Lab [WX-010-0080]

# Dimensões do dispositivo L x P x A

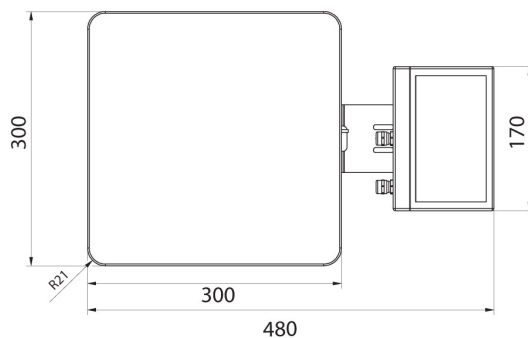
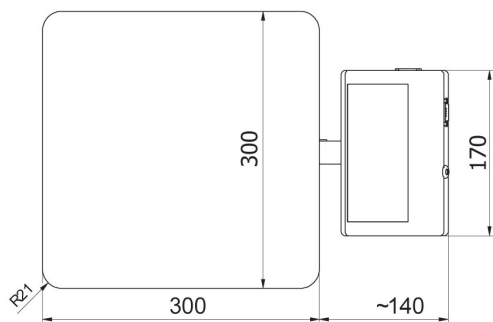
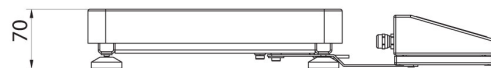
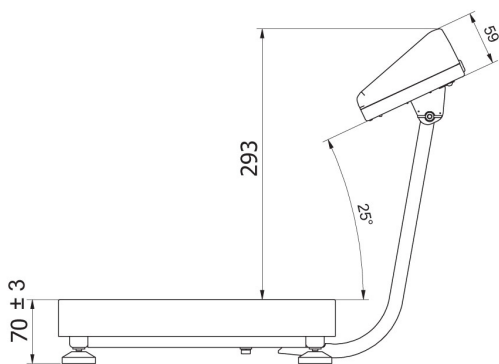

C315.F1.M

C315.F1.R

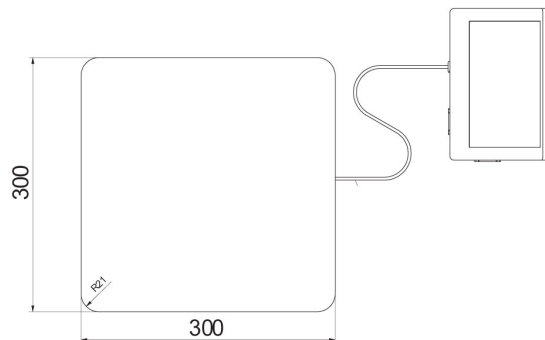
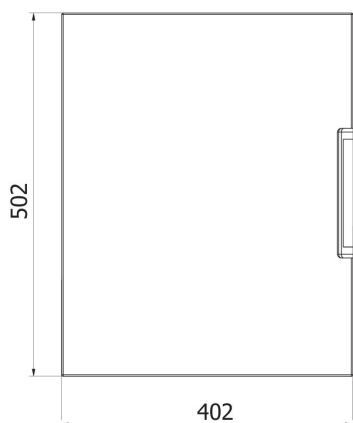
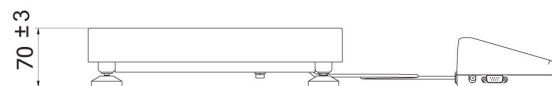
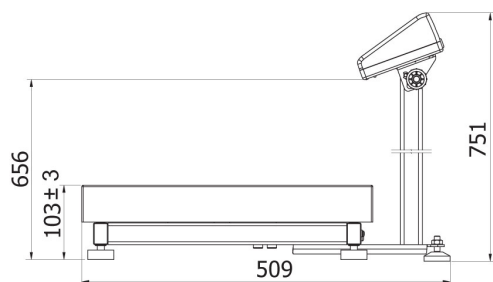

C315.C2.M

C315.C2.K