



PS 750.R1 Precision Balance

WL-213-0022

More information on the website
mirror.radwag.com/en/info,w1,HUB



The drawings, photos and graphics used are for illustrative purposes only.

Functions

-  Autotest
-  Dosing
-  Percent Weighing
-  Totalizing
-  Parts counting
-  Peak hold
-  Newton unit measurement
-  Statistics
-  Checkweighing
-  Under-pan weighing
-  GLP Procedures
-  Animal weighing
-  Density determination

Datasheet

Metrological parameters	
Maximum capacity [Max]	750 g
Minimum load	20 mg
Readability [d]	0.001 g
Tare range	-750 g
Repeatability (Max)	0.0015 g
Repeatability (5% Max)	0.0005 g

Metrological parameters	
Linearity	±0.003 g
Stabilization time	2 s
Adjustment	external
Sensitivity temperature drift	$2 \times 10^{-6} / ^\circ\text{C} \times \text{Rt}$
Physical parameters	
Leveling system	manual
Display	5.3" LCD (backlit)
Delivery components	Balance, weighing pan, weighing pan shield, grounding bumper ×1, bumper ×3, power supply.
Weighing pan dimensions	128×128 mm
Packaging dimensions W x D x H	475×380×345 mm
Net weight	3.2 kg
Gross weight	4.5 kg
Construction	
Protection class	IP 43
Communication interface	
Communication interface	2×RS232 ¹ , USB-A, USB-B, Wi-Fi (option)
Electrical parameters	
Power supply	Adapter: 100 – 240V AC 50/60Hz 0.6A; 12V DC 1.2A Balance: 12 – 15V DC 0.4A max
Power consumption	4 W
Environmental conditions	
Operating temperature	+10 – +40 °C
Relative humidity	40% – 80%

Repeatability is expressed as a standard deviation from 10 weighing cycles.

Stabilization time depends on the ambient conditions and the dynamics of weighing pan loading; specified for FAST profile.

¹ Barcode scanners, available as weighing instrument accessory, communicate with the instrument via RS232 interface exclusively.

* Wi-Fi® is a registered trademark of Wi-Fi® Alliance.



Accessories (Additional Fee)

Balance Storage Case	RS 232, RS 485 cables
Antivibration Tables	Displays
Power Adapters	Draft Shield
Cigarette lighter receptacle power supply cables	Receipt Printer
USB cable (scale - printer)	Protective cover for balances
Density determination KIT	Under-pan weighing
Barcode scanners	RS 232 cables (scale - printer)
Anti-Draft Chamber for Balances with a 128×128 mm Weighing Pan	

Software (Additional Fee)

• RAD Key [WX-010-0005]

• R-Panel [WX-010-0187]

Device dimensions W x D x H

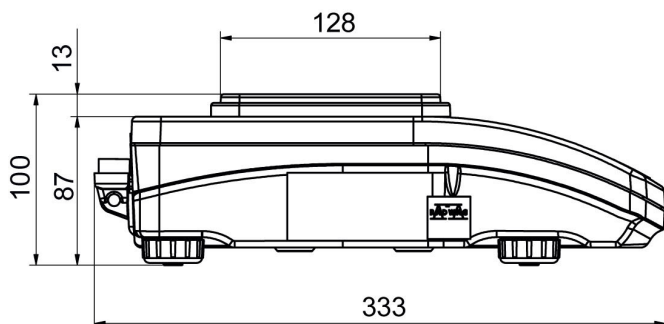

PS R, d = 1 mg

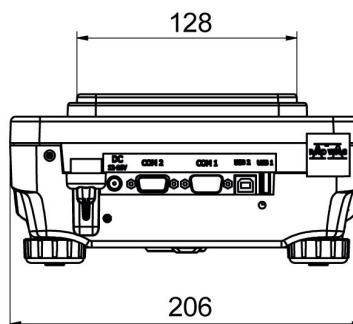

PS R, d = 10 mg

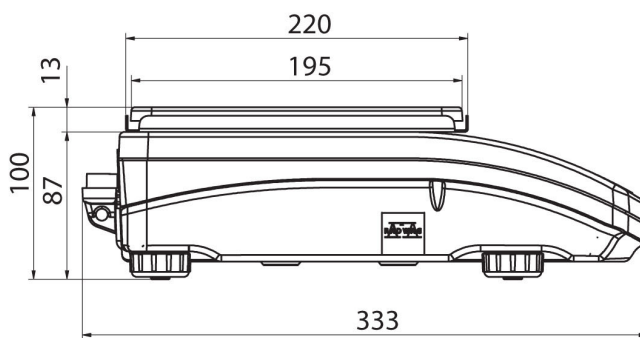

PS R.M, d = 10 mg

