



More information on the website  
[mirror.radwag.com/us/info,w1,HQB](http://mirror.radwag.com/us/info,w1,HQB)



















# HY10.6.H3.K Multifunctional Scale

WP-116-0065



The drawings, photos and graphics used are for illustrative purposes only.

## Functions

-  Dosing
-  Labelling
-  Plus/Minus Control
-  Percent Weighing
-  Totalizing
-  Parts counting
-  Peak hold
-  Formulation
-  Newton unit measurement
-  Statistics
-  Checkweighing
-  GLP Procedures
-  Animal weighing
-  Differential weighing
-  Replaceable unit
-  Statistical Quality Control
-  ALIBI Memory
-  Transactions

## Datasheet

Metrological parameters	
Maximum capacity [Max]	6 kg
Minimum load	40 g
Readability [d]	2 g
Verification unit [e]	2 g

<b>Metrological parameters</b>	
Tare range	-6 kg
Max readability for non-verified scale	0,2 g
Adjustment	external
OIML Class	III
<b>Physical parameters</b>	
Display	10,1" graphic colour touchscreen
Cable length	2,5 m
Weighing pan dimensions	410×410 mm
Packaging dimensions W x D x H	510×510×500 mm
Net weight	16 kg
Gross weight	18 kg
<b>Construction</b>	
Protection class	IP 66 / 67 construction, IP 66 / 67 / 69 terminal
<b>Communication interface</b>	
Communication interface	2×RS232, 2×USB-A, Ethernet, 4 IN / 4 OUT (digital)
Optional interfaces	module Wi-Fi 802.11 b/g/n, module Profibus (DP SLAVE), module RS485, module PROFINET (RJ45), analog output module (4-20mA, 0-20mA, 0-10V) , 12IN / 12OUT (IN – 5-24 VDC, OUT – max 30 VDC, 0,5 ADC)
<b>Electrical parameters</b>	
Power supply	100 – 240 V AC 50/60 Hz
<b>Environmental conditions</b>	
Operating temperature	-10 – +40 °C
Relative humidity	10% – 85% RH no condensation

\* Wi-Fi® is a registered trademark of Wi-Fi® Alliance.



Additional fee for verification



## Accessories (Additional Fee)

AP2-4 Current Loop Unit  
 RS 232 cables (scale - printer)  
 Transponder card readers  
 RS 232 cables (scale - ZEBRA printer)  
 Antivibration tables  
 Ethernet cables (scale - Ethernet)  
 Displays  
 RS 232, RS 485 cables  
 IN/OUT Cables  
 Barcode scanners

Label Printers  
 Stands, wall mounting kits and mounting brackets  
 Keypad, external switches  
 Receipt Printer  
 F1 Mass Standard -  
 knob weights without adjustment chamber, set  
 USB cable (scale - printer)  
 Additional Weighing platforms Module  
 Additional modules  
 RS 232 – USB Converter  
 Roller table

## Software (Additional Fee)

• E2R Weighing [WX-010-0099]

• RAD Key [WX-010-0005]

- Audit Trail Reader [WX-010-0186]
- RADWAG Remote Desktop [WX-010-0107]
- RADWAG Development Studio [WX-010-0104]

- Label Editor R02 [WX-010-0094]
- Scale Editor - EWAG 2.1 [WX-010-0173]

## Device dimensions W x D x H



Scale type	A1	A2	B
HY10 H1.K	200	150	85 ±3
HY10 H2.K	250	300	103 ±3
HY10 H3.K	410	410	98 ±2
HY10 H4.K	500	500	155 ±5
HY10 H5.K	600	600	155 ±5
HY10 H6.K	800	800	135 ±5

dimensions in mm

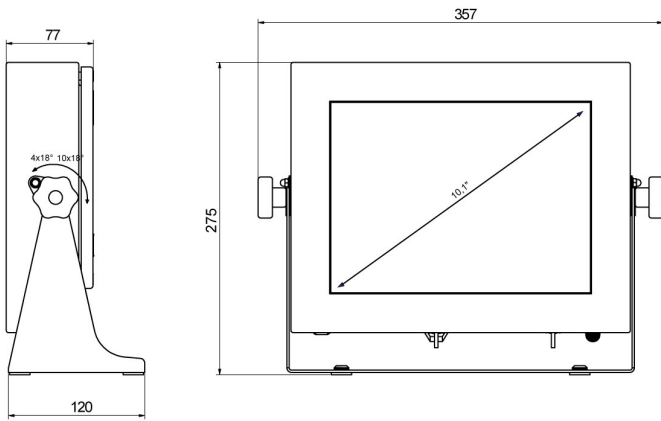

PUE HY10