

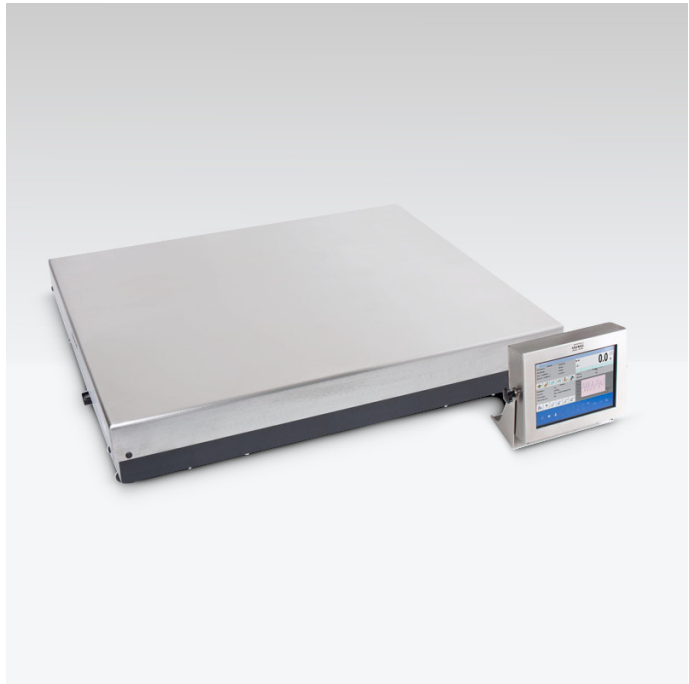

More information on the website  
[mirror.radwag.com/us/info,w1,HH2](http://mirror.radwag.com/us/info,w1,HH2)



















# HY10.1100.HRP.M2.2 High Resolution Scale

WP-330-0032



The drawings, photos and graphics used are for illustrative purposes only.

## Functions

-  Dosing
-  Labelling
-  Plus/Minus Control
-  Percent Weighing
-  Totalizing
-  Parts counting
-  Peak hold
-  Formulation
-  Newton unit measurement
-  Statistics
-  Checkweighing
-  GLP Procedures
-  Animal weighing
-  Differential weighing
-  Replaceable unit
-  Statistical Quality Control
-  ALIBI Memory
-  Transactions

## Datasheet

| Metrological parameters |         |
|-------------------------|---------|
| Maximum capacity [Max]  | 1100 kg |
| Minimum load            | 2500 g  |
| Preload range           | 100 kg  |

| <b>Metrological parameters</b>         |   |
|--|---|
| Readability [d]                        | 50 g  |
| Verification unit [e]                  | 50 g  |
| Tare range                             | -1100 kg  |
| Repeatability                          | 15 g  |
| Linearity                              | ±50 g   |
| Stabilization time                     | 3 s   |
| Adjustment                             | internal (automatic)  |
| OIML Class                             | II  |
| Maximum quantity of verification units | 22000 e   |
| <b>Physical parameters</b>             |   |
| Display                                | 10,1" graphic colour touchscreen  |
| Weighing pan dimensions                | 1000×800 mm   |
| Packaging dimensions W x D x H         | 1000×1200×666 mm  |
| Net weight                             | 126 kg  |
| Gross weight                           | 160 kg  |
| <b>Construction</b>                    |   |
| Protection class                       | IP 66 / 67 construction, IP 66 / 67 / 69 terminal   |
| Construction                           | mild steel St3S   |
| Weighing pan material                  | Stainless steel AISI304   |
| <b>Communication interface</b>         |   |
| Communication interface                | 2×RS232, 2×USB-A, Ethernet, 4 IN / 4 OUT (digital)  |
| Optional interfaces                    | module Wi-Fi 802.11 b/g/n, module Profibus (DP SLAVE), module RS485, module PROFINET (RJ45), analog output module (4-20mA, 0-20mA, 0-10V) , 12IN / 12OUT (IN – 5-24 VDC, OUT – max 30 VDC, 0,5 ADC) |
| <b>Electrical parameters</b>           |   |
| Power supply                           | 100 – 240 V AC 50/60 Hz   |
| <b>Environmental conditions</b>        |   |
| Operating temperature                  | +10 – +40 °C  |
| Relative humidity                      | 15% – 80%   |

\* Wi-Fi® is a registered trademark of Wi-Fi® Alliance.



Additional fee for verification



## Accessories (Additional Fee)

AP2-4 Current Loop Unit  
 RS 232 cables (scale - printer)  
 Transponder card readers  
 RS 232 cables (scale - ZEBRA printer)  
 Ethernet cables (scale - Ethernet)  
 Displays  
 RS 232, RS 485 cables

Label Printers  
 Stands, wall mounting kits and mounting brackets  
 Keypad, external switches  
 Receipt Printer  
 USB cable (scale - printer)  
 Additional Weighing platforms Module  
 Additional modules

## Software (Additional Fee)

- E2R Weighing [WX-010-0099]
- Audit Trail Reader [WX-010-0186]
- RADWAG Remote Desktop [WX-010-0107]
- RADWAG Development Studio [WX-010-0104]
- RAD Key [WX-010-0005]
- Label Editor R02 [WX-010-0094]
- Scale Editor - EWAG 2.1 [WX-010-0173]

## Device dimensions W x D x H

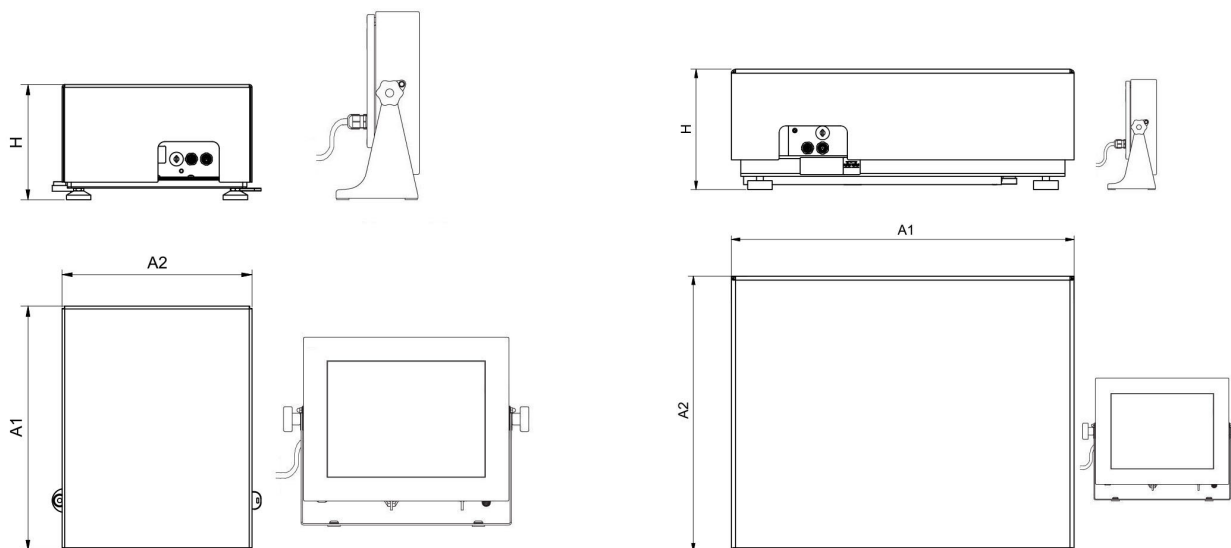

HY10.16 - 32.HRP

HY10.HRP

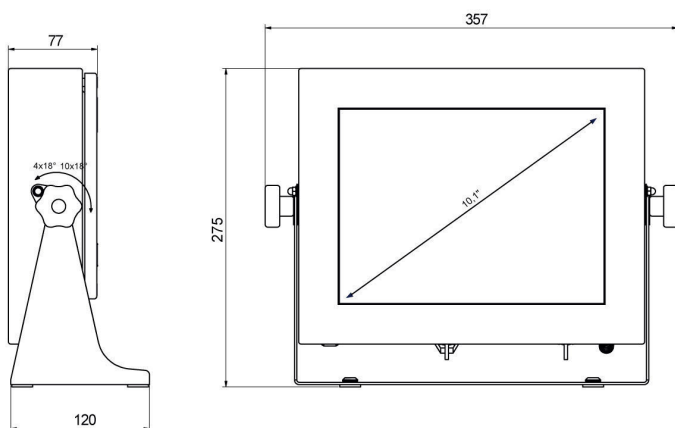

PUE HY10

| Scale type            | A1   | A2   | H     |
|-----------------------|------|------|-------|
| HY10.(16-32).HRP      | 360  | 280  | 180±5 |
| HY10.(62-150).HRP     | 500  | 400  | 180±5 |
| HY10.150.2.HRP        | 500  | 500  | 180±5 |
| HY10.(150.1-300).HRP  | 800  | 600  | 180±5 |
| HY10.(300.1-1100).HRP | 1000 | 800  | 180±5 |
| HY10.(2000).HRP       | 1250 | 1000 | 180±5 |

Dimensions in mm