



More information on the website
mirror.radwag.com/es/info,w1,H72

Báscula multifuncional C32.15.F1.M

WP-120-0015



The drawings, photos and graphics used are for illustrative purposes only.

Funciones



Etiquetado



Control más/menos



Desviaciones porcentuales



Resumiendo pesajes



Contar piezas



Medición en Newtons



Estadísticas



Sensores infrarrojos



Procedimientos GLP



Unidades intercambiables



Memoria Alibi

Datos técnicos

Parámetros metrológicos	
Maxima capacidad [Max]	15 kg
Minima capacidad	100 g
Legibilidad [d]	5 g
Rango de tara	-15 kg
Legibilidad máxima para las balanzas no verificadas	0,5 g
Clase OIML	III

Parámetros físicos	
Pantalla	5" gráfico color
Dimensión de platillo	300×300 mm
Dimensiones de embalaje An x Pr x Al	570×390×170 mm
Masa neta	5,3 kg
Masa bruta	6,6 kg
Construcción	
Grado de protección	IP 65 construcción, IP 43 terminal
Construcción	de acero con recubrimiento en polvo St3S
Material del platillo	Acero inoxidable AISI304
Interface de comunicación	
Conectividad	2×RS232, USB-A, USB-B, Ethernet, 4 IN / 4 OUT (digitales), Wi-Fi
Parámetros eléctricos	
Alimentación	100 – 240 V AC 50/60 Hz
Consumo máximo de potencia	10 W
Corriente de alimentación adicional	batería interna
Horas de trabajo con baterías	5 horas
Condiciones ambientales	
Temperatura de trabajo	-10 – +40 °C

*Equipo opcional con costo adicional

* Wi-Fi® is a registered trademark of Wi-Fi® Alliance.



Additional fee for verification



Accesorios (Additional Fee)

Pantallas

Adaptadores de corriente

Cables RS 232 (Bascula a Impresora)

Cables de corriente desde mechero de automóvil

Escáner de códigos de barra

Cables RS 232, RS 485

Impresoras de etiquetas

Teclado, manipuladores

Soportes, brazos

Módulos adicionales

Impresoras de recibos

Programas (Additional Fee)

• E2R Pesajes [WX-010-0099]

• Editor de Etiquetas R02 [WX-010-0094]

• R-LAB [WX-010-0080]

• RADWAG Development Studio [WX-010-0104]

• RAD Key [WX-010-0005]

• Alibi Reader PC Software [WX-010-0114]

• Editor de Balanzas 2.1 [WX-010-0173]

Dimensiones de aparato An x Pr x Al

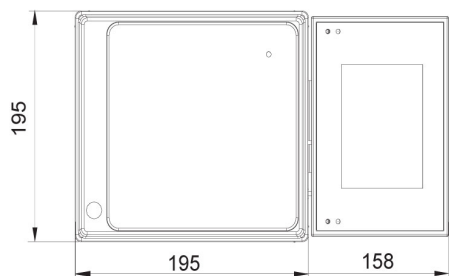

C32.D2

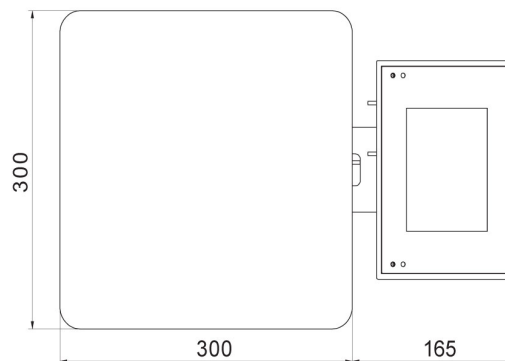
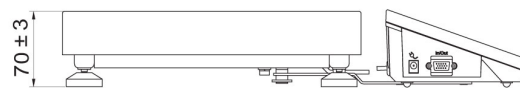

C32.F1.R

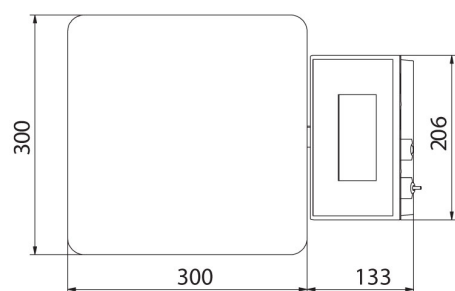
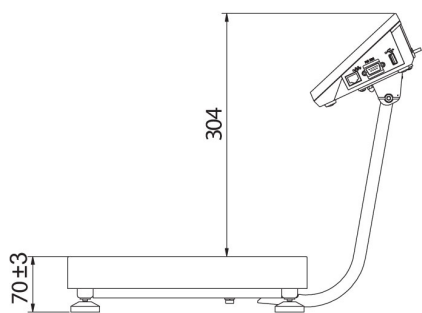

C32.F1.M

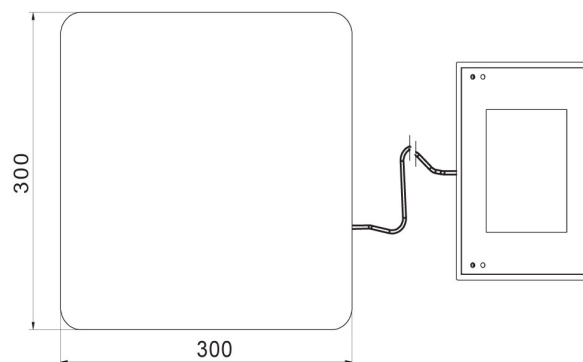
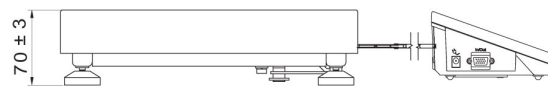

C32.F1.K