

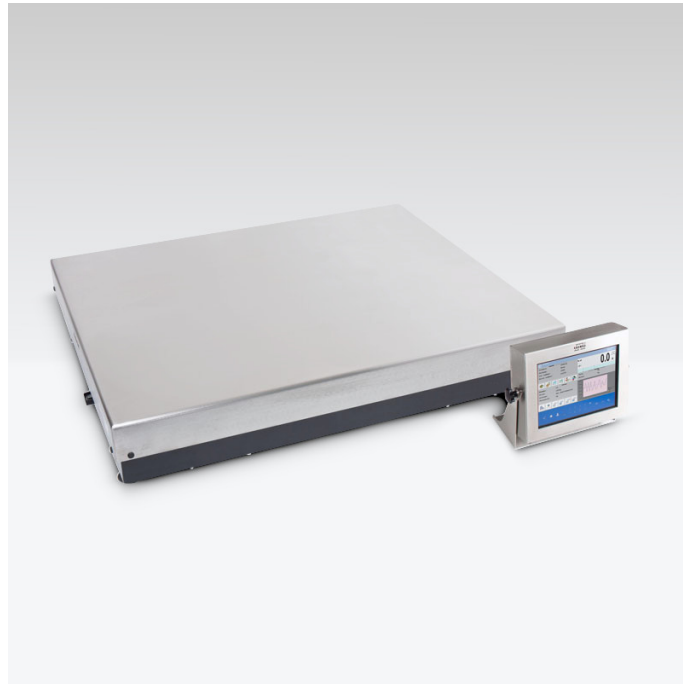

More information on the website
mirror.radwag.com/de/info,w1,GSP



















Waage mit hoher Auflösung HY10.1000.HRP.M3

WP-330-1008



The drawings, photos and graphics used are for illustrative purposes only.

Funktionen

-  Dosing
-  Labelling
-  Plus/Minus Control
-  Percent Weighing
-  Totalizing
-  Parts counting
-  Peak hold
-  Formulation
-  Newton unit measurement
-  Statistics
-  Checkweighing
-  GLP Procedures
-  Animal weighing
-  Differential weighing
-  Replaceable unit
-  Statistical Quality Control
-  ALIBI Memory
-  Transactions

Technische Daten

Messtechnische Parameter	
Wägebereich [Max]	200 / 500 / 1000 kg
Min. Belastung	400 / 1000 / 2000 g
Vorlast	60 kg

Messtechnische Parameter	
Ablesbarkeit [d]	20 / 50 / 100 g
Eichwert [e]	20 / 50 / 100 g
Tarierbereich	-1000 kg
Wiederholbarkeit	15 / 15 / 30 g
Linearität	±20 / ±50 / ±100 g
Stabilisierungszeit	3 s
Justierung	intern (automatisch)
OIML-Klasse	III
Max. Anzahl der Eichwerte	10000 / 10000 / 10000 e
Physikalische Parameter	
Display	10,1" grafisch farbiger Touchscreen
Waagschale	1000×800 mm
Verpackungsgröße B x T x H	1000×1200×666 mm
Nettogewicht	126 kg
Bruttogewicht	160 kg
Konstruktion	
Schutzart	IP 66 / 67 Konstruktion, IP 66 / 67 / 69 Terminal
Konstruktion	pulverbeschichteter Stahl St3S
Waageschale	Edelstahl AISI304
Kommunikationsschnittstellen	
Schnittstellen	2×RS232, 2×USB-A, Ethernet, 4 IN / 4 OUT (Digitalausgang)
Optionale Schnittstellen	Modul Wi-Fi 802.11 b/g/n, Modul Profibus (DP SLAVE), Modul RS485, Modul PROFINET (RJ45), Analogausgangsmodule (4-20mA, 0-20mA, 0-10V) , 12IN / 12OUT (IN – 5-24 VDC, OUT – max 30 VDC, 0,5 ADC)
Elektrische Parameter	
Stromversorgung	100 – 240 V AC 50/60 Hz
Umgebungsbedingungen	
Umgebungstemperatur	+10 – +40 °C
Relative Luftfeuchtigkeit	15% – 80%

Wiederholbarkeit wird als Standardabweichung von 10 Wägezyklen ausgedrückt.

Relative Luftfeuchtigkeit unter nicht kondensierenden Bedingungen.

Stabilisierungszeit unter optimalen Umgebungsbedingungen.

* Wi-Fi® is a registered trademark of Wi-Fi® Alliance.



Additional fee for verification



Zubehör (Additional Fee)

Ausgang der Stromschnittstelle AP2-4
Kabel RS 232 (Waage – Drucker)
Transponderkartenleser
Kabel RS 232 (Waage – Drucker ZEBRA)
Netzkabel (Waage – Ethernet)

Etikettendrucker
Wandhalterung, Stativ
Tastaturen, Taster
Thermische Drucker
USB-Kabel (Waage – Drucker)

Displays
 Kabel RS 232, RS 485
 E/A Kabel
 Barcode-Scanner

Modul für zusätzliche Wägeplattformen
 Zusätzliche Module
 Konverter RS 232 – USB

Software (Additional Fee)

- E2R Wägung [WX-010-0099]
- Audit Trail Reader [WX-010-0186]
- Radwag Remote Desktop [WX-010-0107]
- Scale Editor 2.1 [WX-010-0173]
- RAD Key [WX-010-0005]
- Etiketten-Editor R02 [WX-010-0094]
- RLAB [WX-010-0080]
- RADWAG Development Studio [WX-010-0104]

Abmessungen des Geräts B x T x H



HY10.16 - 32.HRP



HY10.HRP



PUE HY10

Scale type	A1	A2	H
HY10.(16-32).HRP	360	280	180±5
HY10.(62-150).HRP	500	400	180±5
HY10.150.2.HRP	500	500	180±5
HY10.(150.1-300).HRP	800	600	180±5
HY10.(300.1-1100).HRP	1000	800	180±5
HY10.(2000).HRP	1250	1000	180±5

Dimensions in mm