



More information on the website  
[mirror.radwag.com/en/info,w1,FS4](https://mirror.radwag.com/en/info,w1,FS4)

## KIT 195 Density Determination Kit

WX-002-0021



The drawings, photos and graphics used are for illustrative purposes only.

### Overview

KIT 195 is a density determination kit intended for laboratory balances featuring 195x195 weighing pan.

This stainless steel accessory allows determining density of: solids, liquids. For testing granulates of density value higher or lower than 1 g/cm<sup>3</sup> use KIT 85.

### Compatible with (Additional Fee)

WLC X7 Precision Balance  
WLC Precision Balance

WLC C/2 Precision Balance  
PS R2 Precision Balance

# Device dimensions W x D x H



KIT 85

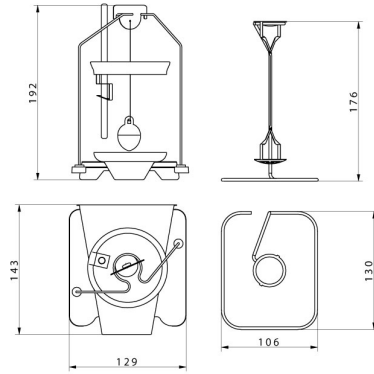

KIT 128

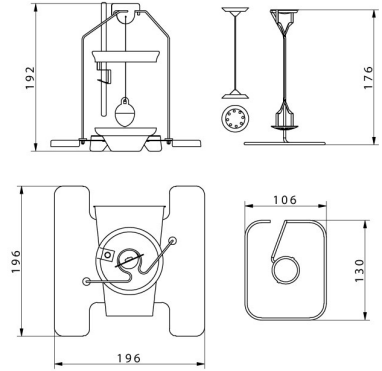

KIT 195



KIT 195.M



Granulte density determination KIT