

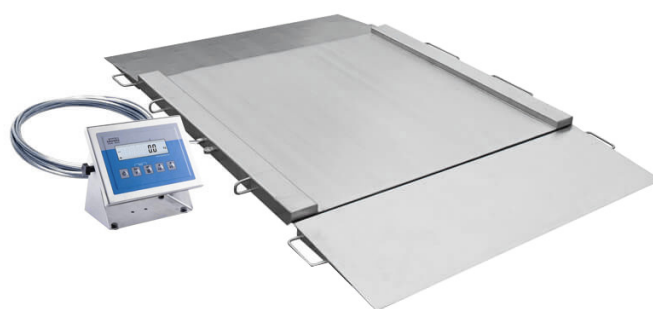

More information on the website
mirror.radwag.com/es/info,w1,FHB

Báscula inoxidable con rampa H315.4N.600.H3

WP-234-0009





The drawings, photos and graphics used are for illustrative purposes only.

Funciones

 Control más/menos

 Desviaciones porcentuales

 Resumiendo pesajes

 Contar piezas

 Batería interna

 Cierre de la indicación máxima

 Medición en Newtons

 Pesar animales

Datos técnicos

Parámetros metrológicos	
Maxima capacidad [Max]	600 kg
Minima capacidad	4 kg
Legibilidad [d]	200 g
División de legalización [e]	200 g
Rango de tara	-600 kg
Legibilidad máxima para las balanzas no verificadas	100 g
Clase OIML	III

Parámetros físicos	
Pantalla	4,3" LCD (con retroiluminación)
Longitud del cable	3 m
Dimensión de platillo	1200×1500 mm
Dimensiones de embalaje An x Pr x Al	1600×1600×500 mm
Masa de balanza con indicador	180 kg
Construcción	
Grado de protección	IP 66 / 69 construcción, IP 66 / 67 / 69 medidor
Interface de comunicación	
Conectividad	RS232, USB
Interfaces opcionales	RS232 o RS485 o 4IN/4OUT o Ethernet o entradas analógica 4-20 mA
Parámetros eléctricos	
Alimentación	100 – 240 V AC 50/60 Hz
Corriente de alimentación adicional	batería interna
Horas de trabajo con baterías	max 7h
Condiciones ambientales	
Temperatura de trabajo	-10 – +40 °C
Humedad relativa de aire	10% – 85% RH sin condensación



Additional fee for verification



Accesorios (Additional Fee)

Salidas del bucle de corriente AP2-4
 Cables RS 232 (Bascula a Impresora)
 Pantallas
 Cables de corriente (Bascula a Ethernet)
 Cables RS 232, RS 485
 Adaptadores de corriente

Convertidor RS 232 a Ethernet
 Adaptadores USB
 Impresoras de recibos
 Cable USB (Bascula a Impresora)
 Soportes, brazos
 Convertidor RS 232 a USB

Programas (Additional Fee)

• RAD Key [WX-010-0005]
 • Editor de Balanzas 2.1 [WX-010-0173]

• R-LAB [WX-010-0080]

Dimensiones de aparato An x Pr x Al



Model	Max	A	B	C	C1	D	E	F	G	H
H315.4N.150.H1	150 kg	840	860	45,5	76	1040	1710	778	940	1170
H315.4N.300.H1	300 kg	840	860	45,5	76	1040	1710	778	940	1170
H315.4N.600.H1	600 kg	840	860	45,5	76	1040	1710	778	940	1170
H315.4N.150.H2	1500 kg	1100	1200	45,5	76	1300	2050	1118	1200	1430
H315.4N.300.H2	300 kg	1100	1200	45,5	76	1300	2050	1118	1200	1430
H315.4N.600.H2	600 kg	1100	1200	45,5	76	1300	2050	1118	1200	1430
H315.4N.1500.H2	1500 kg	1100	1200	52,5	76	1300	2150	1118	1200	1430
H315.4N.300.H3	300 kg	1200	1500	45,5	76	1400	2350	1418	1300	1530
H315.4N.600.H3	600 kg	1200	1500	45,5	76	1400	2350	1418	1300	1530
H315.4N.1500.H3	1500 kg	1200	1500	52,5	76	1400	2450	1418	1300	1530
H315.4N.300.H4	300 kg	1500	1500	52,5	76	1700	2450	1418	1600	1830
H315.4N.600.H4	600 kg	1500	1500	52,5	76	1700	2450	1418	1600	1830
H315.4N.1500.H4	1500 kg	1500	1500	52,5	76	1700	2450	1418	1600	1830