



More information on the website
mirror.radwag.com/br/info,w1,EHG

Plataforma de pesagem C315.1,5.F1.K

WP-123-0002





The drawings, photos and graphics used are for illustrative purposes only.

Funções

 Plus/Minus Control

 Percent Weighing

 Totalizing

 Parts counting

 Internal battery

 Peak hold

 Newton unit measurement

 GLP Procedures

 Animal weighing

 ALIBI Memory

Ficha Técnica

Parâmetros metrológicos

Capacidade máxima [máx]	1,5 kg
Carga mínima	10 g
Resolução [d]	0,5 g
Unidade de verificação [e]	0,5 g
Faixa de tara	-1,5 kg
Resolução máxima para plataforma não verificada	0,2 g
Classe OIML	III

Parâmetros físicos	
Display	4,3" LCD (retroiluminado)
Comprimento até cabo	1 m
Dimensões até prato de pesagem	300×300 mm
Dimensões da embalagem L x P x A	570×390×170 mm
Peso líquido	5,3 kg
Peso bruto	5,5 kg
Construção	
Classe de proteção	IP 65 construção, IP 43 terminal
Construção	aço carbono St3S
Material até prato de pesagem	aço inoxidável AISI304
Interface de comunicação	
Interface de comunicação	RS232
Interfaces opcionais	RS232
Parâmetros elétricos	
Fonte de alimentação	100 – 240 V AC 50/60 Hz e bateria
Consumo de energia máx.	5 W
Tempo de operação com baterias	max 8h
Condições ambientais	
Temperatura de operação	-10 – +40 °C
Temperatura de armazenamento	-10 – +50 °C
Umidade relativa	10% – 85% RH sem condensação
Indicador	C315



Additional fee for verification



Acessórios (Additional Fee)

Mesas antivibração
 Adaptadores de energia
 Cabos de alimentação para acendedor de cigarro automotivo
 Displays
 RS 232, RS 485 cabos

Conversor RS 232 – Ethernet
 RS 232 – Conversor USB
 Cabos RS 232 (plataforma - impressora)
 Conversor RS 232 – RS 485
 Impressora de recibos

Software (Additional Fee)

• RAD Key [WX-010-0005]

• R-Lab [WX-010-0080]

Dimensões do dispositivo L x P x A

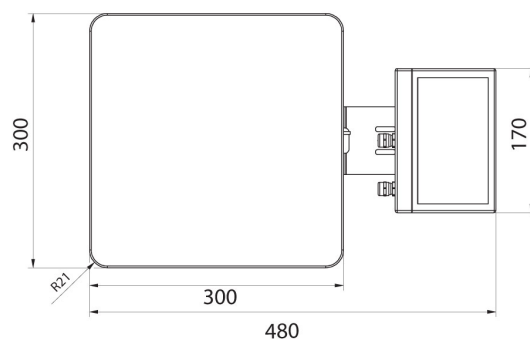
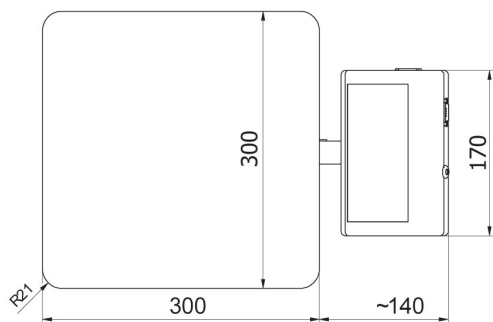
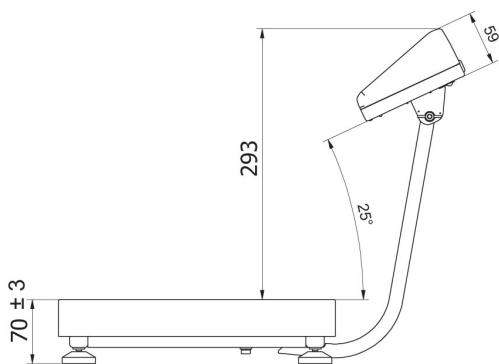

C315.F1.M

C315.F1.R

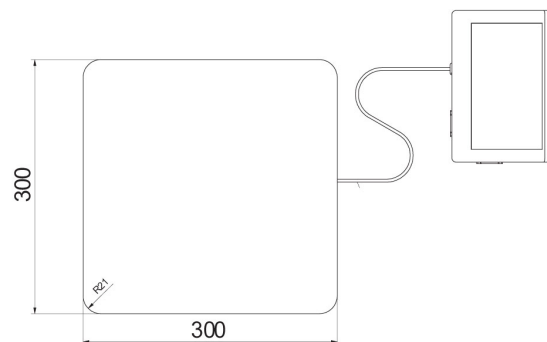
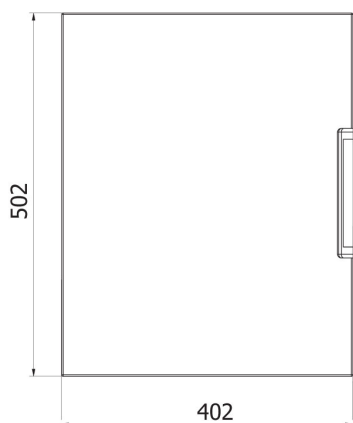
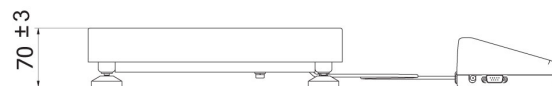
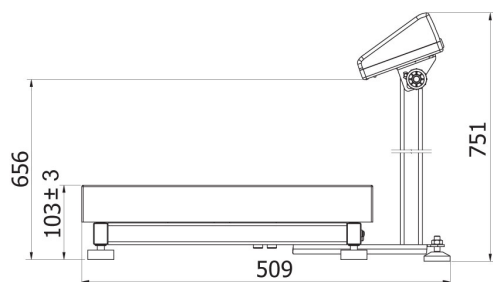

C315.C2.M

C315.C2.K