



HY10.300.H6.K Çok Fonksiyonlu Terazı



















WP-116-0024

More information on the website
mirror.radwag.com/tr/info,w1,DYI



The drawings, photos and graphics used are for illustrative purposes only.

Fonksiyonlar

-  Dosing
-  Labelling
-  Plus/Minus Control
-  Percent Weighing
-  Totalizing
-  Parts counting
-  Peak hold
-  Formulation
-  Newton unit measurement
-  Statistics
-  Checkweighing
-  GLP Procedures
-  Animal weighing
-  Differential weighing
-  Replaceable unit
-  Statistical Quality Control
-  ALIBI Memory
-  Transactions

Teknik Veriler

Metrolojik parametreler

Maksimum yük [Max]	300 kg
Minimum yük [Min]	2 kg
Okuma için ğruluđu [d]	100 g
Yasallařtırma birimi [e]	100 g

Metrolojik parametreler	
Dara aralığı	-300 kg
Ticari amaçla kullanılmayan terazi için maksimum hassasiyet	20 g
Ayarlama	harici
OIML sınıfı	III
Fiziksel parametreler	
Display	10,1" grafik renkli dokunmatik
Kablo uzunluğu	2,5 m
Tartım kefesi boyutları	800x800 mm
Ambalaj boyutları G x D x Y	820x1250x500 mm
Net ağırlık	43 kg
Brüt ağırlık	47 kg
Konstrüksiyon	
IP Sınıfı	IP 66 / 67 konstrüksiyon, IP 66 / 67 / 69 terminal
Haberleşme arayüzler	
Haberleşme arayüzü	2xRS232, 2xUSB-A, Ethernet, 4 IN / 4 OUT (dijital)
Opsiyonel arayüzler	modül Wi-Fi 802.11 b/g/n, modül Profibus (DP SLAVE), modül RS485, modül PROFINET (RJ45), analog çıkış modülü (4-20mA, 0-20mA, 0-10V), 12IN / 12OUT (IN – 5-24 VDC, OUT – max 30 VDC, 0,5 ADC)
Elektrik parametreleri	
Güç kaynağı	100 – 240 V AC 50/60 Hz
Çevresel koşullar	
Çalıştırma sıcaklığı	-10 – +40 °C
Atmosferik nem	10% – 85% RH yoğunlaşma yok

* Wi-Fi® is a registered trademark of Wi-Fi® Alliance.



Additional fee for verification



Aksesuarlar (Additional Fee)

AP2-4 Güç döngüsü çıkışı
RS 232 Kablolar (Teraziler - Yazıcı)
Transponder kart okuyucular
RS 232 Kabloları (Teraziler - ZEBRA Yazıcı)
Ağ kabloları (Teraziler - Ethernet)
Display
RS 232, RS 485 Kabloları
Giriş/Çıkış kabloları
Barkod okuyucu

Etiket Yazıcısı
Tartım terminalleri için tutucular
Klavye
Fiş yazıcı
F1 Kütle standardı - ayar odacısız silindirik ağırlıklar, setleri
USB Kablolar (terazi-Epson yazıcı)
Modülleri ek platformları
Ek modüller
RS 232 – USB Dönüştürücü

Yazılım (Additional Fee)

- E2R Tartım [WX-010-0099]
- Audit Trail Reader [WX-010-0186]
- RADWAG Remote Desktop [WX-010-0107]
- Terazi Editörü - EWAG 2.1 [WX-010-0173]

- RAD Key [WX-010-0005]
- Etiket Editörü R02 [WX-010-0094]
- R-Lab [WX-010-0080]
- RADWAG Development Studio [WX-010-0104]

Cihaz boyutları G x D x Y



H Platform

Scale type	A1	A2	B
HY10 H1.K	200	150	85 ±3
HY10 H2.K	250	300	103 ±3
HY10 H3.K	410	410	98 ±2
HY10 H4.K	500	500	155 ±5
HY10 H5.K	600	600	155 ±5
HY10 H6.K	800	800	135 ±5

dimensions in mm

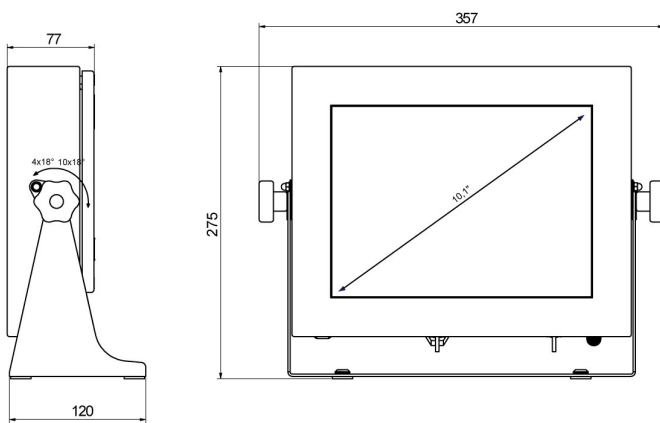

PUE HY10