



More information on the website  
[mirror.radwag.com/it/info,w1,DYI](http://mirror.radwag.com/it/info,w1,DYI)



















# Bilancia multifunzione HY10.300.H6.K

WP-116-0024



The drawings, photos and graphics used are for illustrative purposes only.

## Funzioni

-  Dosing
-  Labelling
-  Plus/Minus Control
-  Percent Weighing
-  Totalizing
-  Parts counting
-  Peak hold
-  Formulation
-  Newton unit measurement
-  Statistics
-  Checkweighing
-  GLP Procedures
-  Animal weighing
-  Differential weighing
-  Replaceable unit
-  Statistical Quality Control
-  ALIBI Memory
-  Transactions

## Specifiche

Parametri metrologici	
Portata massima [Max]	300 kg
Portata minima [Min]	2 kg
Divisione [d]	100 g
Intervallo di verifica della bilancia [e]	100 g

Parametri metrologici	
Campo di tara	-300 kg
Massima leggibilità per bilance non verificate	20 g
Calibrazione	external
Classe OIML	III
Parametri fisici	
Display	10,1" graphic colour touchscreen
Lunghezza del cavo	2,5 m
Dimensione piatto	800×800 mm
Dimensioni del pacco L x P x A	820×1250×500 mm
Peso net	43 kg
Peso lordo	47 kg
Costruzione	
Punteggio IP	IP 66 / 67 construction, IP 66 / 67 / 69 terminal
Interfaccia di comunicazione	
Interfaccia	2×RS232, 2×USB-A, Ethernet, 4 IN / 4 OUT (digital)
Interfacce opzionali	module Wi-Fi 802.11 b/g/n, module Profibus (DP SLAVE), module RS485, module PROFINET (RJ45), analog output module (4-20mA, 0-20mA, 0-10V) , 12IN / 12OUT (IN – 5-24 VDC, OUT – max 30 VDC, 0,5 ADC)
Parametri elettrici	
Alimentatore	100 – 240 V AC 50/60 Hz
Environmental conditions	
Ambiente di lavoro	-10 – +40 °C
Umidità relativa	10% – 85% RH no condensation

\* Wi-Fi® is a registered trademark of Wi-Fi® Alliance.



Additional fee for verification



## Accessori (Additional Fee)

AP2-4 Modulo di conversione analogica  
 Cavo seriale RS 232 (connessione bilance - Stampanti)  
 Lettore di tessere transponder  
 Cavo seriale RS 232 (connessione bilance - Stampanti ZEBRA)  
 Cavi di rete (connessione bilance - Ethernet)  
 Display  
 Cavo seriale RS 232, RS 485  
 Cavi IN/OUT  
 Lettore di codici a barre

stampanti per etichette  
 Supporto, set di montaggio a muro e braccetti di montaggio  
 Tastiera, interruttori esterni  
 Stampanti di ricevuta  
 Pesi standard F1 - cilindrici, set  
 Cavo USB (connessione bilance - stampanti)  
 Moduli aggiuntivi della piattaforma  
 Moduli aggiuntivi  
 Convertitore RS 232 – USB

## Software (Additional Fee)

- E2R Weighing [WX-010-0099]
- Audit Trail Reader [WX-010-0186]
- RADWAG Remote Desktop [WX-010-0107]

- RAD Key [WX-010-0005]
- Editore di etichette R02 [WX-010-0094]
- R-LAB [WX-010-0080]

## Device dimensions L x P x A



Scale type	A1	A2	B
HY10 H1.K	200	150	85 ±3
HY10 H2.K	250	300	103 ±3
HY10 H3.K	410	410	98 ±2
HY10 H4.K	500	500	155 ±5
HY10 H5.K	600	600	155 ±5
HY10 H6.K	800	800	135 ±5

dimensions in mm

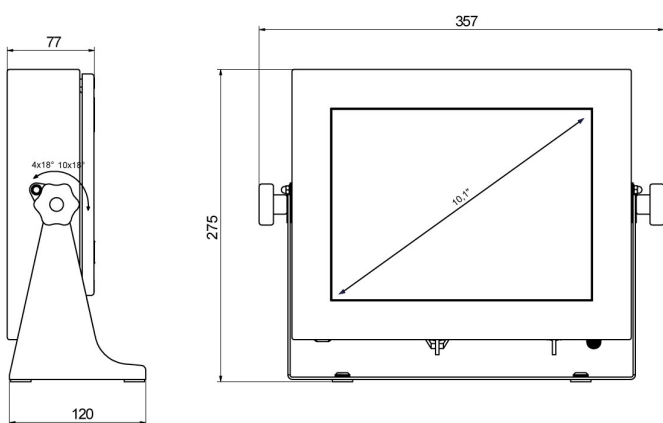

PUE HY10