





















Báscula multifuncional HY10.30.H5.K

WP-116-0054



The drawings, photos and graphics used are for illustrative purposes only.

Funciones

-  Dosificación
-  Etiquetado
-  Control más/menos
-  Desviaciones porcentuales
-  Resumiendo pesajes
-  Contar piezas
-  Cierre de la indicación máxima
-  Recetas
-  Medición en Newtons
-  Estadísticas
-  Controlador de peso
-  Procedimientos GLP
-  Pesar animales
-  Pesaje diferencial
-  Unidades intercambiables
-  Control estadístico de calidad
-  Memoria Alibi
-  Transacciones

Datos técnicos

Parámetros metrológicos

Maxima capacidad [Max]	30 kg
Minima capacidad	200 g
Legibilidad [d]	10 g
División de legalización [e]	10 g

Parámetros metrológicos	
Rango de tara	-30 kg
Legibilidad máxima para las balanzas no verificadas	1 g
Calibración	externa
Clase OIML	III
Parámetros físicos	
Pantalla	10,1" gráfico color pantalla táctil
Longitud del cable	2,5 m
Dimensión de platillo	600x600 mm
Dimensiones de embalaje An x Pr x Al	710x710x560 mm
Masa neta	30 kg
Masa bruta	33 kg
Construcción	
Grado de protección	IP 66 / 67 construcción, IP 66 / 67 / 69 terminal
Interface de comunicación	
Conectividad	2xRS232, 2xUSB-A, Ethernet, 4 IN / 4 OUT (digitales)
Interfaces opcionales	módulo Wi-Fi 802.11 b/g/n, módulo Profibus (DP SLAVE), módulo RS485, módulo PROFINET (RJ45), módulo de salida analógica (4-20mA, 0-20mA, 0-10V) , 12IN / 12OUT (IN – 5-24 VDC, OUT – max 30 VDC, 0,5 ADC)
Parámetros electricos	
Alimentación	100 – 240 V AC 50/60 Hz
Condiciones ambientales	
Temperatura de trabajo	-10 – +40 °C
Humedad relativa de aire	10% – 85% RH sin condensación

* Wi-Fi® is a registered trademark of Wi-Fi® Alliance.



Additional fee for verification



Accesorios (Additional Fee)

Cables RS 232 (Bascula a Impresora)
 Lector de tarjetas transpondedor
 Cables RS 232 (Bascula a Impresora ZEBRA)
 Mesas antivibratil
 Cables de corriente (Bascula a Ethernet)
 Soportes con transportadores con rollos
 Pantallas
 Cables RS 232, RS 485
 Cables Entradas/Salidas
 Escáner de códigos de barra

Impresoras de etiquetas
 Soportes, brazos
 Teclado, manipuladores
 Impresoras de recibos
 Pesas de clase F1 - cilíndrico sin cámara de ajuste, juegos
 Cable USB (Bascula a Impresora)
 Módulos adicionales de la plataforma
 Módulos adicionales
 Convertidor RS 232 a USB

Programas (Additional Fee)

- E2R Pesajes [WX-010-0099]
- Audit Trail Reader [WX-010-0186]

- RAD Key [WX-010-0005]
- Editor de Etiquetas R02 [WX-010-0094]

Dimensiones de aparato An x Pr x Al

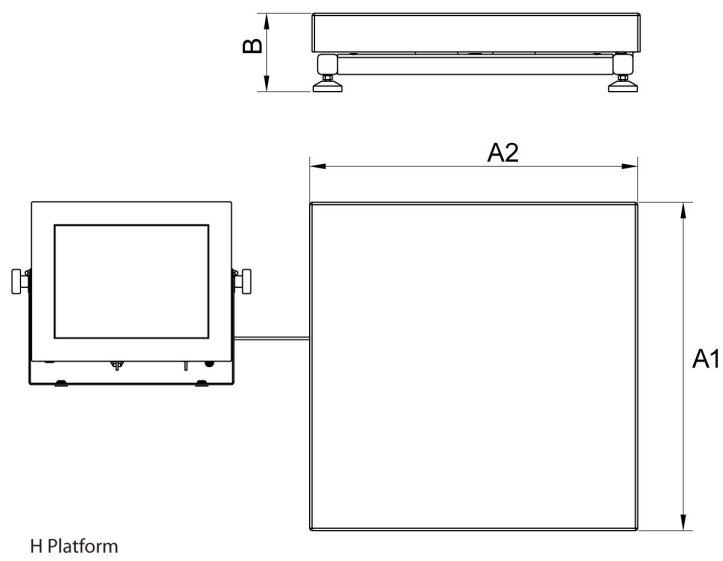

Scale type	A1	A2	B
HY10 H1.K	200	150	85 ±3
HY10 H2.K	250	300	103 ±3
HY10 H3.K	410	410	98 ±2
HY10 H4.K	500	500	155 ±5
HY10 H5.K	600	600	155 ±5
HY10 H6.K	800	800	135 ±5

dimensions in mm

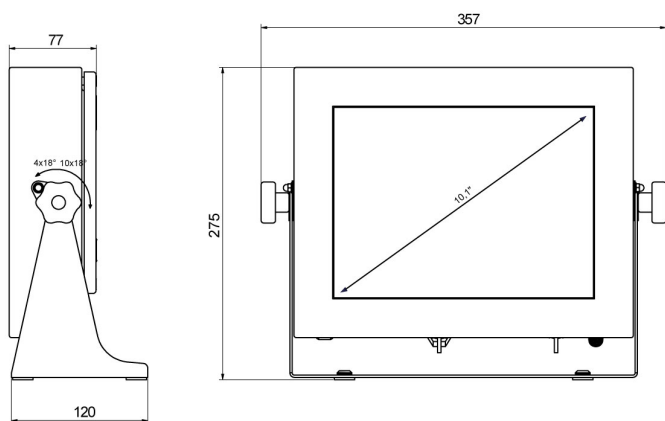

PUE HY10