

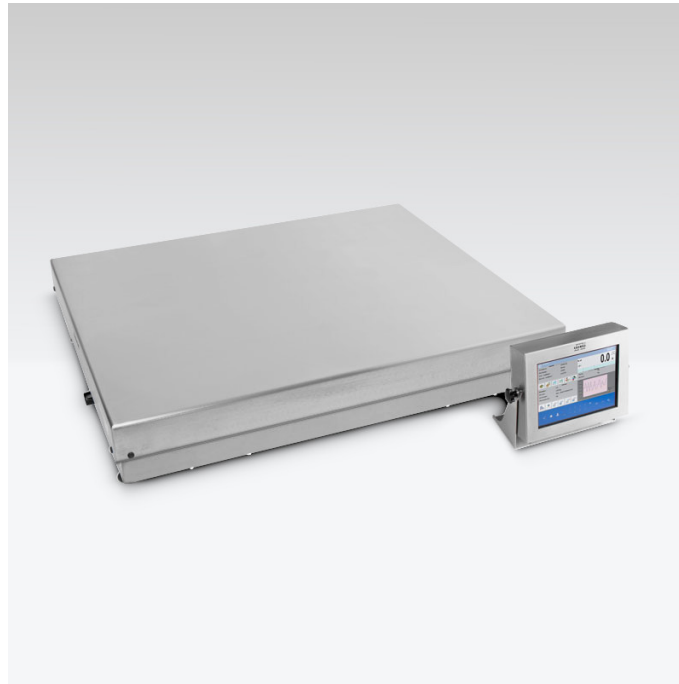

More information on the website
mirror.radwag.com/fr/info,w1,BSW



















Balance à haute résolution HY10.2000.HRP.H

WP-340-0012



The drawings, photos and graphics used are for illustrative purposes only.

Fonctions

-  Dosing
-  Labelling
-  Plus/Minus Control
-  Percent Weighing
-  Totalizing
-  Parts counting
-  Peak hold
-  Formulation
-  Newton unit measurement
-  Statistics
-  Checkweighing
-  GLP Procedures
-  Animal weighing
-  Differential weighing
-  Replaceable unit
-  Statistical Quality Control
-  ALIBI Memory
-  Transactions

Paramètres Techniques

Paramètres métrologiques	
Capacité maximale [Max]	2000 kg
Capacité minimale [Min]	500 g
Capacité préliminaire	200 kg

Paramètres métrologiques	
Précision de lecture [d]	10 g
Étendue de tare	-2000 kg
Répétabilité	30 g
Linéarité	±60 g
Temps de stabilisation	3 s
Ajustage	interne (automatique)
Paramètres physiques	
Afficheur	10,1" graphique couleurs écran tactile
Dimension du plateau	1250×1000 mm
Dimensions de colis L x P x H	1250×1500×843 mm
Masse nette	300 kg
Masse brute	425 kg
Construction	
Degré de protection	IP 66 / 67 construction, IP 66 / 67 / 69 terminal
Construction	Acier inoxydable AISI304
Matériel du plateau	Acier inoxydable AISI304
Interface de Communication	
Interface de Communication	2×RS232, 2×USB-A, Ethernet, 4 IN / 4 OUT (numériques)
Interfaces optionnelles	module Wi-Fi 802.11 b/g/n, module Profibus (DP SLAVE), module RS485, module PROFINET (RJ45), module de sorties analogiques (4-20mA, 0-20mA, 0-10V) , 12IN / 12OUT (IN – 5-24 VDC, OUT – max 30 VDC, 0,5 ADC)
Paramètres électriques	
Alimentation	100 – 240 V AC 50/60 Hz
Conditions environnementales	
Température du travail	+10 – +40 °C
Humidité relative d'air	15% – 80%

Répétabilité exprimée comme un écart standardisé de 10 placements de chargé.

Humidité relative de l'air dans des conditions sans condensation.

Temps de stabilisation dans des conditions ambiantes optimales.

* Wi-Fi® is a registered trademark of Wi-Fi® Alliance.



Accessoires (Additional Fee)

Sorties de boucle de courant AP2-4
 Câbles RS 232 (balance – imprimante)
 Lecteurs de cartes à transpondeur
 Câbles RS 232 (balance – imprimante ZEBRA)
 Câbles de réseau (balance – Ethernet)
 Afficheurs
 Câbles RS 232, RS 485
 Câbles d'Entrées/ de Sorties
 Lecteurs de code-barres

Imprimantes d étiquettes
 Supports, Statifs, bras-supports
 Claviers, manipulateurs
 Imprimante de tickets de caisse
 Câble USB (balance – imprimante)
 Modules de plateforme supplémentaires
 Modules complémentaires
 Convertisseur RS 232 – USB

Software (Additional Fee)

- E2R Pesages [WX-010-0099]
- Audit Trail Reader [WX-010-0186]
- RADWAG Remote Desktop [WX-010-0107]
- Éditeur de Balances 2.1 [WX-010-0173]
- RAD Key [WX-010-0005]
- Éditeur D'étiquettes R02 [WX-010-0094]
- R-LAB [WX-010-0080]
- RADWAG Studio du Développement [WX-010-0104]

Dimensions d'appareil L x P x H

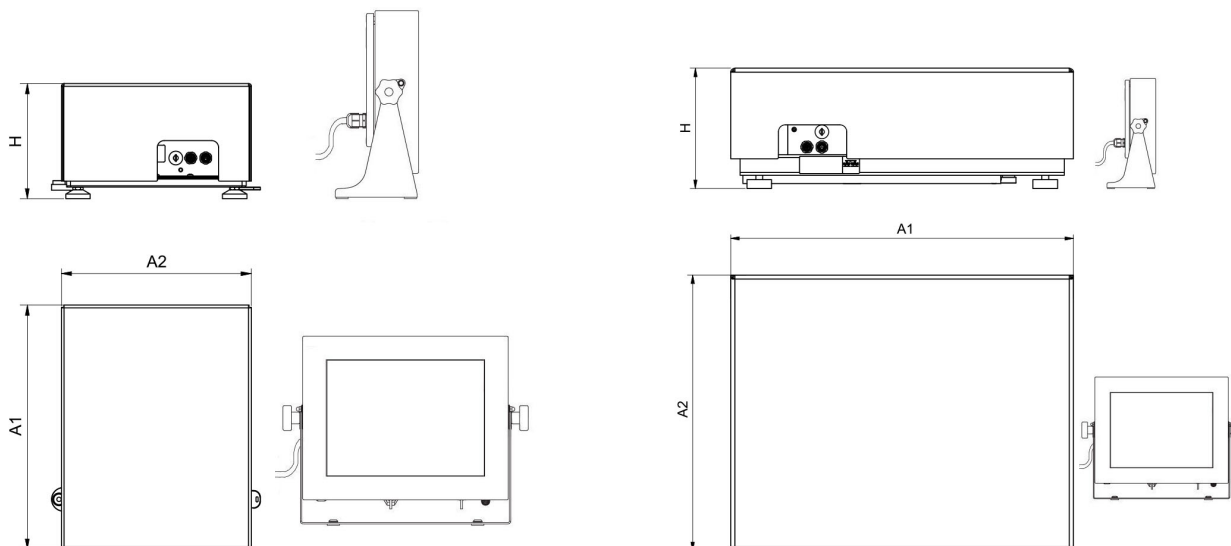

HY10.16 - 32.HRP.H

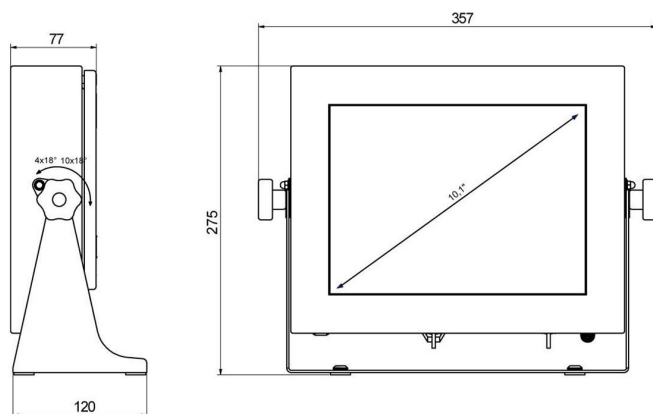

PUE HY10

Scale type	A1	A2	H
HY10.(16-32).HRP.H	360	280	180±5
HY10.(62-150).HRP.H	500	400	180±5
HY10.150.2.HRP.H	500	500	180±5
HY10.(150.1-300).HRP.H	800	600	180±5
HY10.(300.1-1100).HRP.H	1000	800	180±5
HY10.(2000).HRP.H	1250	1000	180±5

Dimensions in mm