



More information on the website  
[mirror.radwag.com/br/info,w1,BH9](http://mirror.radwag.com/br/info,w1,BH9)

# Plataforma de pesagem C315.150.C3.M

WP-123-0037



The drawings, photos and graphics used are for illustrative purposes only.

## Funções

 Plus/Minus Control

 Percent Weighing

 Totalizing

 Parts counting

 Internal battery

 Peak hold

 Newton unit measurement

 GLP Procedures

 Animal weighing

 ALIBI Memory

## Ficha Técnica

### Parâmetros metrológicos

Capacidade máxima [máx]	150 kg
Carga mínima	1 kg
Resolução [d]	50 g
Unidade de verificação [e]	50 g
Faixa de tara	-150 kg
Resolução máxima para plataforma não verificada	5 g
Classe OIML	III

<b>Parâmetros físicos</b>	
Display	4,3" LCD (retroiluminado)
Dimensões até prato de pesagem	500×700 mm
Dimensões da embalagem L x P x A	730×800×270 mm
Peso líquido	23,4 kg
Peso bruto	26 kg
<b>Construção</b>	
Classe de proteção	IP 65 construção, IP 43 terminal
Construção	aço carbono St3S
Material até prato de pesagem	aço inoxidável AISI304
<b>Interface de comunicação</b>	
Interface de comunicação	RS232
Interfaces opcionais	RS232
<b>Parâmetros elétricos</b>	
Fonte de alimentação	100 – 240 V AC 50/60 Hz e bateria
Consumo de energia máx.	5 W
Tempo de operação com baterias	max 8h
<b>Condições ambientais</b>	
Temperatura de operação	-10 – +40 °C
Temperatura de armazenamento	-10 – +50 °C
Umidade relativa	10% – 85% RH sem condensação
Indicador	C315



Additional fee for verification



## Acessórios (Additional Fee)

Adaptadores de energia  
 Cabos de alimentação para acendedor de cigarro automotivo  
 Displays  
 RS 232, RS 485 cabos  
 Conversor RS 232 – Ethernet

RS 232 – Conversor USB  
 Cabos RS 232 (plataforma - impressora)  
 Conversor RS 232 – RS 485  
 Impressora de recibos

## Software (Additional Fee)

• RAD Key [WX-010-0005]

• R-Lab [WX-010-0080]

# Dimensões do dispositivo L x P x A

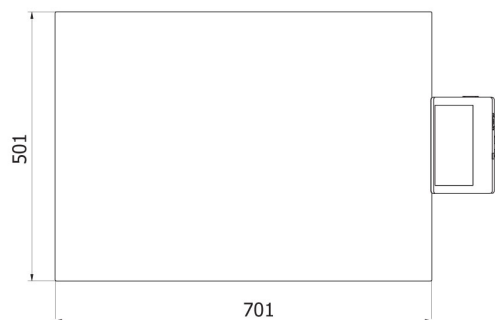
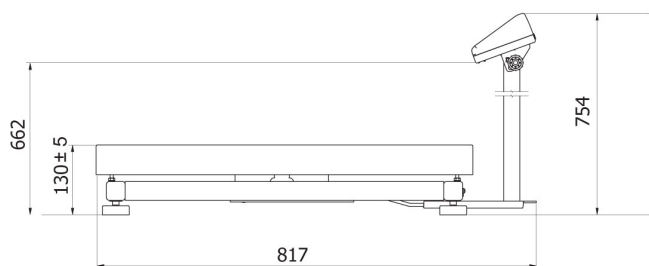
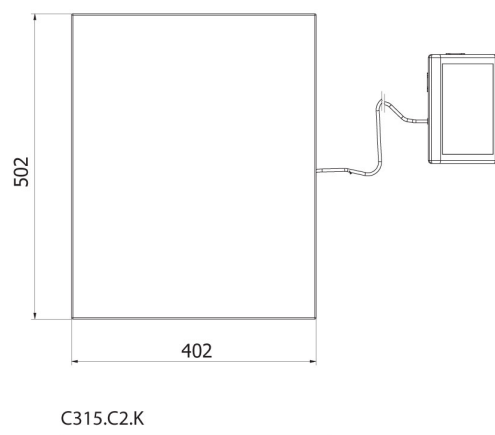
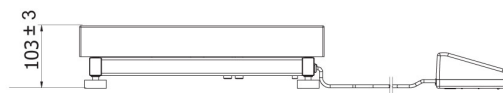
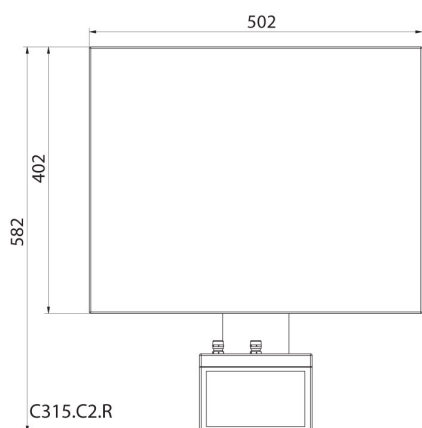
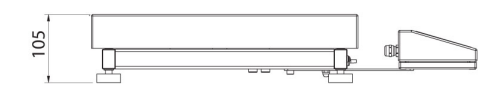

C315.C3.M

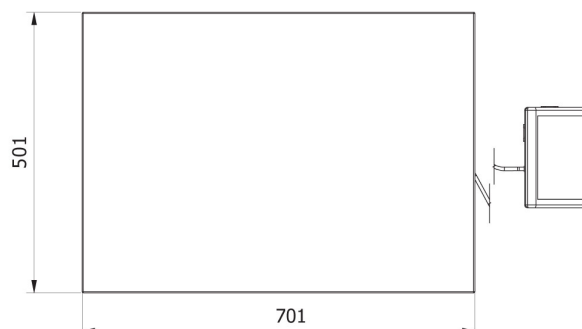
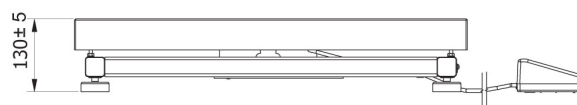

C315.C3.K