



More information on the website
mirror.radwag.com/tr/info,w1,B97

KIT 128 Yoğunluk Tespit Kiti

WX-002-0001



The drawings, photos and graphics used are for illustrative purposes only.

Genel Açıklama

KIT 128 is a density determination kit intended for laboratory balances featuring 128x128 weighing pan.

This stainless steel accessory allows determining density of:

solids, liquids.

For testing granulates of density value higher or lower than 1 g/cm³ use KIT 85.

İle uyumlu (Additional Fee)

PUK için PS 5Y terazileri
PS X7 Hassas Teraziler
PS 5Y Hassas Teraziler

PS R1 Hassas Teraziler
PUK için PS X7 terazileri
PS R2 Hassas Teraziler

Cihaz boyutları G x D x Y



KIT 85

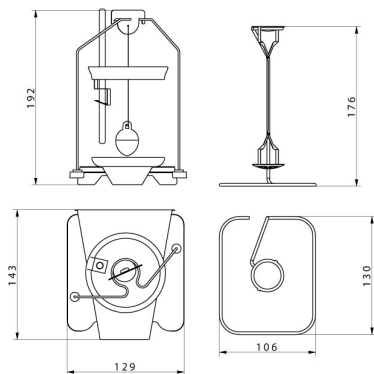

KIT 128

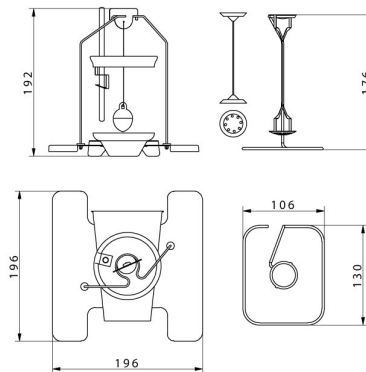

KIT 195



KIT 195.M



Granulte density
determination KIT