



More information on the website
mirror.radwag.com/it/info,w1,B5C

Tavolo di pesata professionale PSW



The drawings, photos and graphics used are for illustrative purposes only.

Specifiche

Parametri fisici	
Componenti del kit	table for calibration, anti-vibration table
Dimensioni del pacco	1160×820×986 mm
Peso netto	150 kg (table 110 + stone 40)
Peso lordo	171 kg
Lunghezza	1100 mm
Larghezza	750 mm
Altezza	1100 mm
Number of workstations	1



Compatibile con

Moduli MAS1
 Microbilancia per la calibrazione delle pipette XA 5Y.M.A.P
 Microbilancia per la calibrazione delle pipette MYA 5Y.P

Bilancia analitica AS 5Y
 Bilance PS 5Y per controllo CPC
 Bilancia di precisione CY10

Bilancia di precisione 5Y.PM
 Microbilancia per filtri MYA 5Y.F
 AS X7 Bilancia analitica
 Bilance analitiche AS X2 PLUS
 Microbilancia XA 5Y.M.A
 Moduli MAS
 Moduli MPS
 Bilancia di precisione C32.PM
 Bilancia analitica XA 5Y.A
 UYA 5Y Ultra-Microbilancia

Bilancia analitica per filtri XA 5Y.F
 Microbilancia MYA 5Y
 Bilancia analitica XA 5Y
 Bilancia analitica AS R2 PLUS
 Bilancia di precisione PS 5Y
 Microbilancia XA 5Y.M
 UYA 5Y.KO Comparatore di massa manuale
 Bilancia analitica AS R1 PLUS
 UYA 5Y.F Ultra-microbilancia per filtri
 Microbilancia per stent XA 5Y.M.A.S

Device dimensions

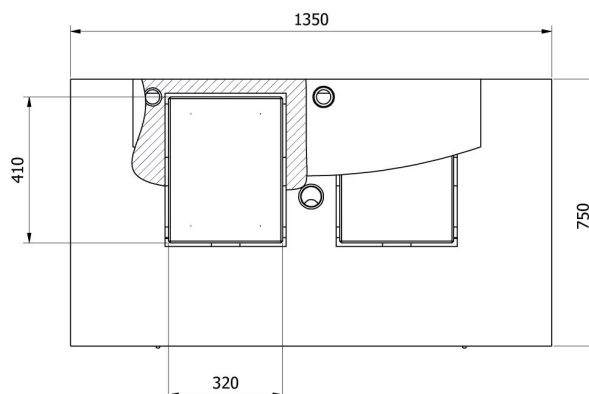
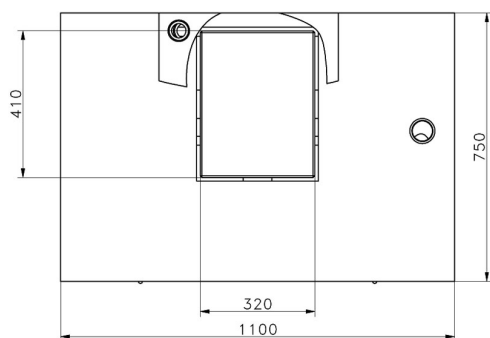
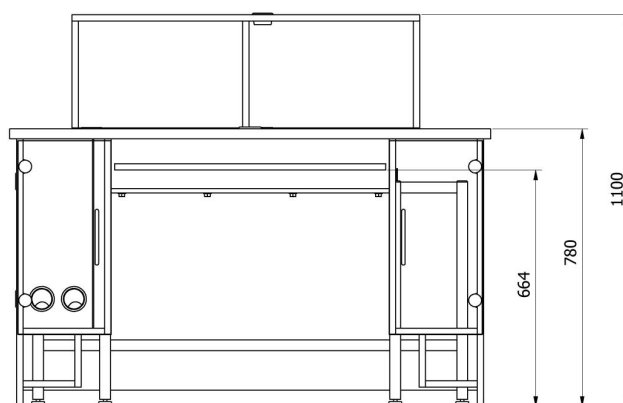
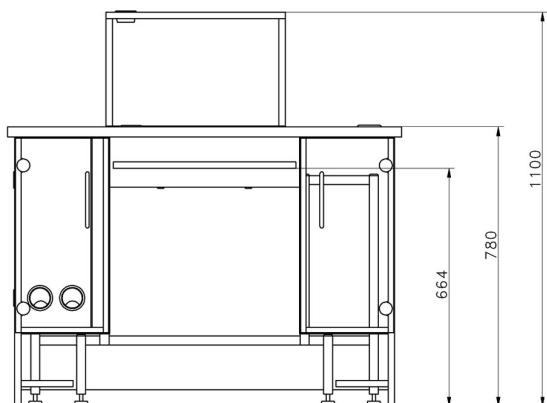

—SDKP

—SDKP DUAL