



More information on the website
mirror.radwag.com/it/info,w1,9WF















Bilancia di precisione WLY 6/D2

WL-219-0001



The drawings, photos and graphics used are for illustrative purposes only.

Funzioni

-  Dosing
-  Labelling
-  Plus/Minus Control
-  Percent Weighing
-  Totalizing
-  Parts counting
-  Peak hold
-  Formulation
-  Newton unit measurement
-  Statistics
-  Checkweighing
-  IR sensors
-  Animal weighing
-  Differential weighing
-  ALIBI Memory

Specifiche

Parametri metrologici	
Portata massima [Max]	6 kg
Portata minima [Min]	5 g
Divisione [d]	0,1 g
Intervallo di verifica della bilancia [e]	1 g
Campo di tara	-6 kg
Ripetibilita	0,1 g

Parametri metrologici	
Linearità	±0,1 g
Tempo di stabilizzazione	3 s
Classe OIML	II
Parametri fisici	
Sistema di livellamento	manual
Dimensione piatto	195×195 mm
Dimensioni del pacco L x P x A	530×310×150 mm
Peso net	2,7 kg
Peso lordo	3,5 kg
Costruzione	
Punteggio IP	IP 43
Interfaccia di comunicazione	
Interfaccia	2×RS232, 2×USB-A, Ethernet, 4 IN / 4 OUT (digital), Wi-Fi
Parametri elettrici	
Alimentatore	Adapter: 100 – 240V AC 50/60Hz 1A; 15V DC 2,4A Balance: 10 – 28V DC 1A max
Environmental conditions	
Ambiente di lavoro	+15 – +30 °C
Temperatura di stoccaggio	-25 – +70 °C
Umidità relativa	10% – 85% RH no condensation

La ripetibilità è espressa come deviazione standard di 10 posizionamenti dello standard di massa.

Il tempo di stabilizzazione dipende dalle condizioni esterne e dalla dinamica di posizionamento del carico sul piatto; specificato per il profilo FAST.

* Wi-Fi® is a registered trademark of Wi-Fi® Alliance.



Accessori (Additional Fee)

Tavoli antivibranti
 Lettore di tessere transponder
 Alimentatore
 Cavo seriale RS 232 (connessione bilance - Stampanti)
 Cavo di alimentazione con spina per accendisigari
 Lettore di codici a barre
 Cavo seriale RS 232, RS 485
 stampanti per etichette
 Moduli aggiuntivi

Display
 cavi IN/OUT
 Tastiera, interruttori esterni
 Supporto, set di montaggio a muro e braccetti di montaggio
 Stampanti di ricevu
 Pesi standard F1 - cilindrici, set
 AP2-1 Power loop output
 Moduli aggiuntivi della piattaforma
 RS 232 – USB Converter

Software (Additional Fee)

- E2R Weighing [WX-010-0099]
- Audit Trail Reader [WX-010-0186]
- RADWAG Remote Desktop [WX-010-0107]
- Editore per sistemi di pesatura 2.1 [WX-010-0173]

- RAD Key [WX-010-0005]
- Editore di etichette R02 [WX-010-0094]
- R-LAB [WX-010-0080]
- Software „Development Studio” RADWAG [WX-010-0104]

Device dimensions L x P x A

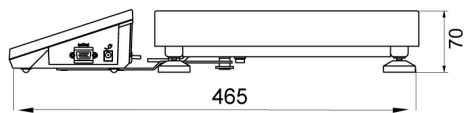

F1 version

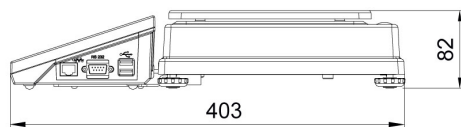

D2 version

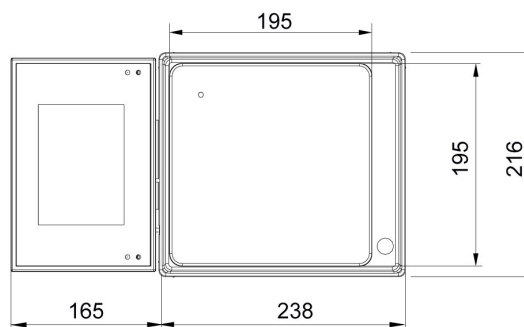

C2 version

