



More information on the website  
[mirror.radwag.com/en/info,w1,9WF](http://mirror.radwag.com/en/info,w1,9WF)

# WLY 6/D2 Precision Balance

WL-219-0001



The drawings, photos and graphics used are for illustrative purposes only.

## Functions

-  Dosing
-  Labelling
-  Plus/Minus Control
-  Percent Weighing
-  Totalizing
-  Parts counting
-  Peak hold
-  Formulation
-  Newton unit measurement
-  Statistics
-  Checkweighing
-  IR sensors
-  Animal weighing
-  Differential weighing
-  ALIBI Memory

## Datasheet

Metrological parameters	
Maximum capacity [Max]	6 kg
Minimum load	5 g
Readability [d]	0.1 g
Verification unit [e]	1 g
Tare range	-6 kg
Repeatability	0.1 g

Metrological parameters	
Linearity	±0.1 g
Stabilization time	3 s
OIML Class	II
Physical parameters	
Leveling system	manual
Weighing pan dimensions	195×195 mm
Packaging dimensions W x D x H	530×310×150 mm
Net weight	3.8 kg
Gross weight	4.2 kg
Construction	
Protection class	IP 43
Communication interface	
Communication interface	2×RS232, 2×USB-A, Ethernet, 4 IN / 4 OUT (digital), Wi-Fi
Electrical parameters	
Power supply	Adapter: 100 – 240V AC 50/60Hz 1A; 15V DC 2.4A Balance: 10 – 28V DC 1A max
Environmental conditions	
Operating temperature	+15 – +30 °C
Storage temperature	-25 – +70 °C
Relative humidity	10% – 85% RH no condensation

**Repeatability** is expressed as a standard deviation from 10 weighing cycles.

**Stabilization time** depends on the ambient conditions and the dynamics of weighing pan loading; specified for FAST profile.

\* Wi-Fi® is a registered trademark of Wi-Fi® Alliance.



## Accessories (Additional Fee)

Antivibration Tables  
 Transponder card readers  
 Power Adapters  
 RS 232 cables (scale - printer)  
 Cigarette lighter receptacle power supply cables  
 Barcode scanners  
 RS 232, RS 485 cables  
 Label Printers  
 Additional modules

Displays  
 IN/OUT Cables  
 Keypad, external switches  
 Stands, wall mounting kits and mounting brackets  
 Receipt Printer  
 F1 Mass Standard -  
 knob weights without adjustment chamber, set  
 AP2-1 Current Loop Unit  
 Additional Weighing platforms Module  
 RS 232 – USB Converter

## Software (Additional Fee)

- E2R Weighing [WX-010-0099]
- Audit Trail Reader [WX-010-0186]
- RADWAG Remote Desktop [WX-010-0107]
- Scale Editor 2.1 [WX-010-0173]

- RAD Key [WX-010-0005]
- Label Editor R02 [WX-010-0094]
- R-Lab [WX-010-0080]
- RADWAG Development Studio [WX-010-0104]

# Device dimensions W x D x H



F1 version

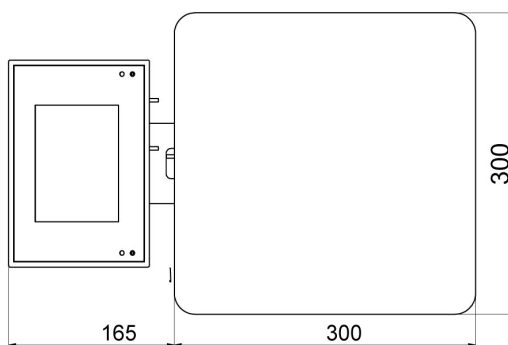

D2 version



C2 version

