



More information on the website
mirror.radwag.com/it/info,w1,9VJ

Anti-Draft Chamber for Microbalances

WX-001-0117



The drawings, photos and graphics used are for illustrative purposes only.

Specifiche

| Parametri fisici | |
|--------------------------------|----------------|
| Dimensioni | 560x350x252 mm |
| Dimensioni del pacco L x P x A | 695x485x385 mm |
| Peso net | 7,6 kg |
| Peso lordo | 10,9 kg |

Compatibile con (Additional Fee)

Microbilancia per la calibrazione delle pipette XA 5Y.M.A.P
Microbilancia per la calibrazione delle pipette MYA 5Y.P
Microbilancia per filtri MYA 5Y.F
Microbilancia XA 5Y.M.A

Microbilancia MYA 5Y
Microbilancia XA 5Y.M
Microbilancia per stent XA 5Y.M.A.S

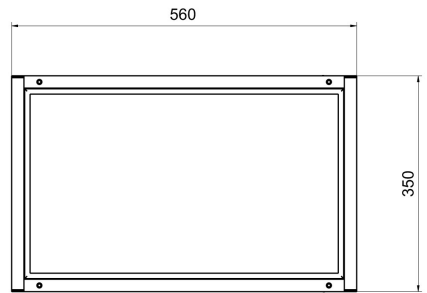
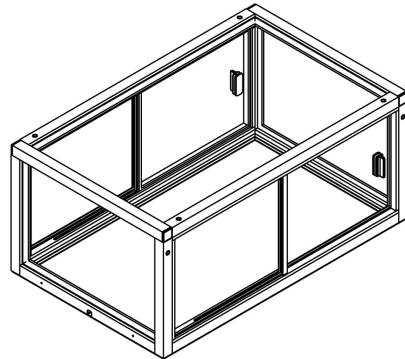
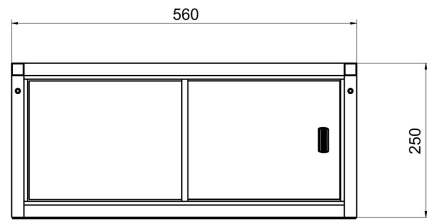
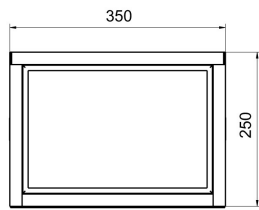

Device dimensions L x P x A

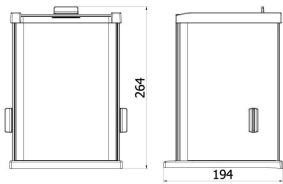

[Anti-draft chamber for balances with 128x128 mm weighing pan](#)

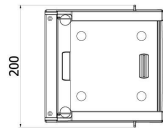

[Anti-draft chamber for X2 and R2 precision balances](#)

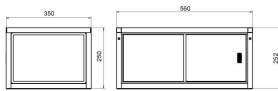
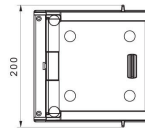
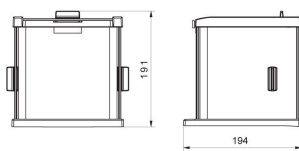

[Anti-draft chamber for microbalances](#)

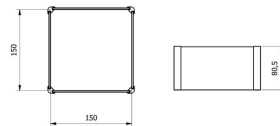

[Draft shield for precision balances](#)

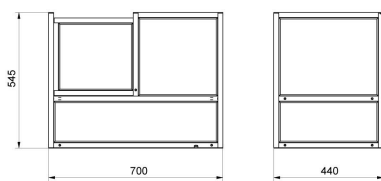

[Anti-draft chamber for APP-00-SK mass comparators](#)

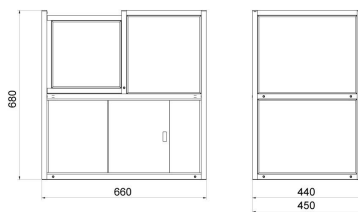

[Anti-draft chamber for APP-KO-SK mass comparators](#)

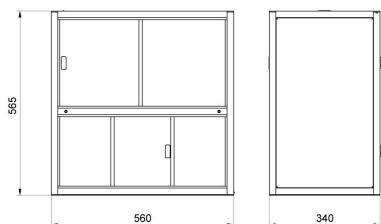

[Anti-draft chamber for WAY-KO mass comparators](#)

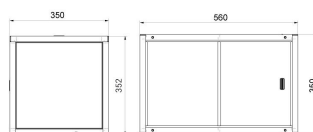

[Anti-draft chamber for XA 5Y / XA 5Y.A balances](#)