



More information on the website  
[mirror.radwag.com/es/info,w1,9VJ](https://mirror.radwag.com/es/info,w1,9VJ)

## Cámara corta aires para microbalanza



The drawings, photos and graphics used are for illustrative purposes only.

### Datos técnicos

Parámetros físicos	
Dimensión	560x350x252 mm
Dimensiones de embalaje	695x485x385 mm
Masa neta	7,6 kg
Masa bruta	10,9 kg

### Trabaja con

Módulo de pesaje MUYA  
 Microbalanza para calibración de pipetas XA 5Y.M.A.P  
 Microbalanza para calibración de pipetas MYA 5Y.P  
 Microbalanza para filtros MYA 5Y.F

Microbalanza XA 5Y.M.A  
 Microbalanza MYA 5Y  
 Microbalanza XA 5Y.M  
 Microbalanza para pesar stents XA 5Y.M.A.S

### Dimensiones de aparato

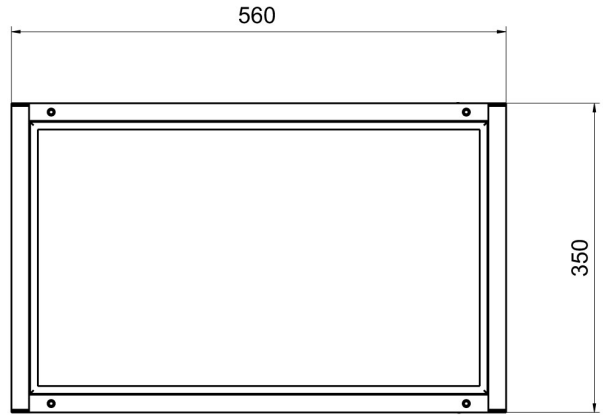
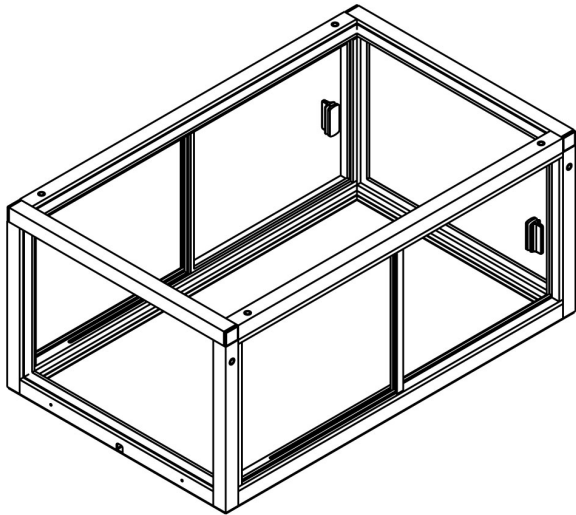
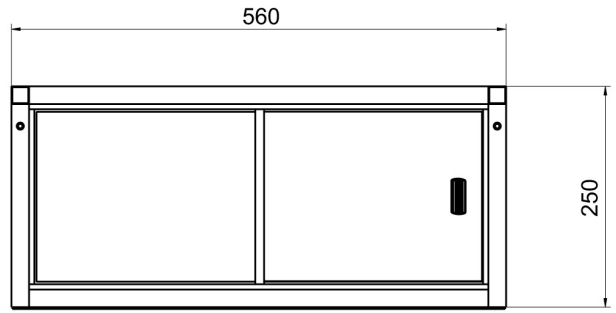
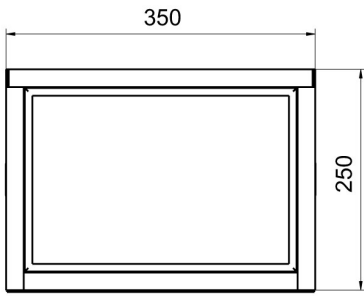

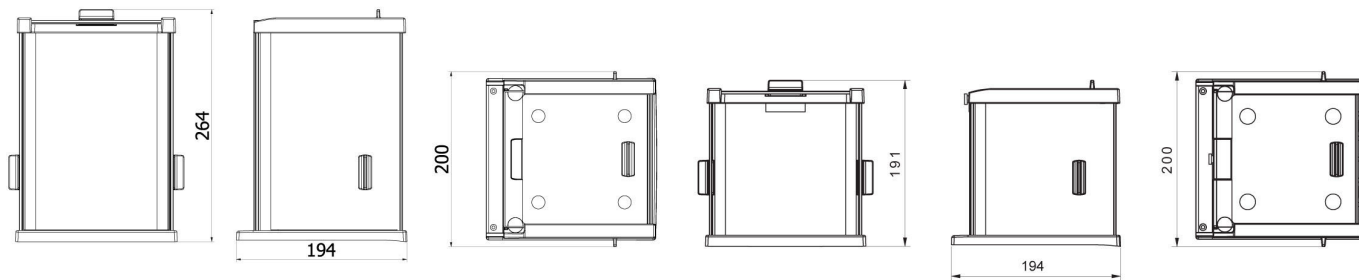

Anti-draft chamber for balances with 128x128 mm weighing pan

Anti-draft chamber for X2 and R2 precision balances

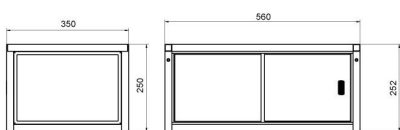

Anti-draft chamber for microbalances

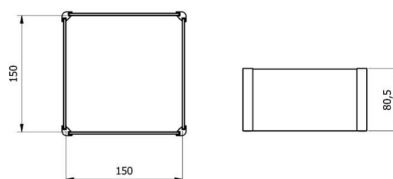

Draft shield for precision balances

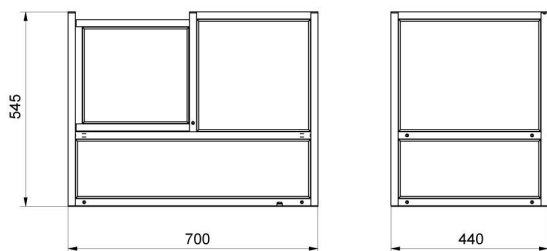

Anti-draft chamber for APP-00-SK mass comparators

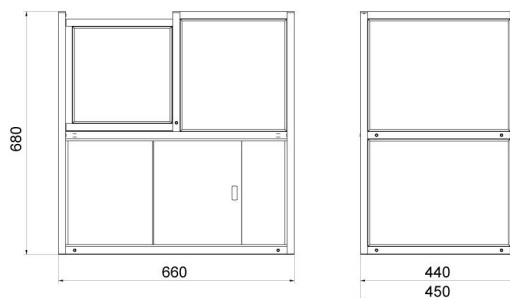

Anti-draft chamber for APP-KO-SK mass comparators

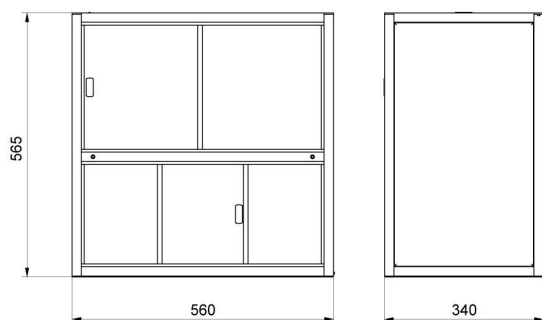

Anti-draft chamber for WAY-KO mass comparators

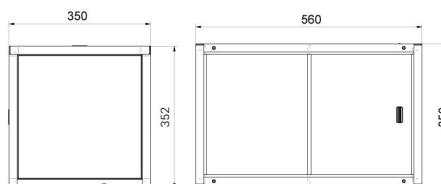

Anti-draft chamber for XA 5Y / XA 5Y.A balances