



More information on the website
mirror.radwag.com/de/info,w1,9VJ

Windschutzschrank für Mikrowaagen

WX-001-0117



The drawings, photos and graphics used are for illustrative purposes only.

Technische Daten

Physikalische Parameter	
Dimension	560x350x252 mm
Verpackungsgröße B x T x H	695x485x385 mm
Nettogewicht	7,6 kg
Bruttogewicht	10,9 kg

Kompatibel mit (Additional Fee)

Mikrowaage für Pipettenkalibrierung XA 5Y.M.A.P
 Mikrowaage für Pipettenkalibrierung MYA 5Y.P
 Mikrowaage für Filterwägung MYA 5Y.F
 Mikrowaage XA 5Y.M.A

Mikrowaage MYA 5Y
 Mikrowaage XA 5Y.M
 Mikrowaage für Stentwägung XA 5Y.M.A.S

Abmessungen des Geräts B x T x H

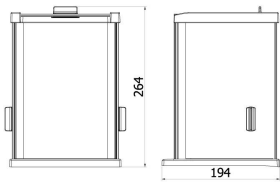
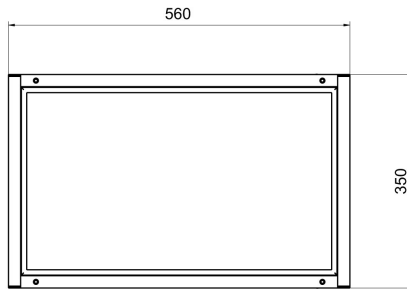
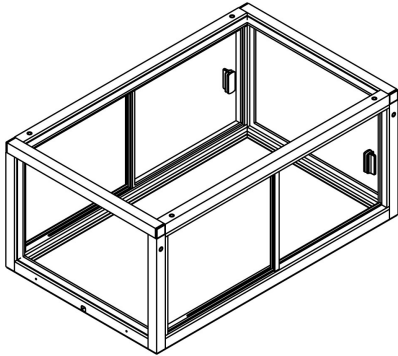
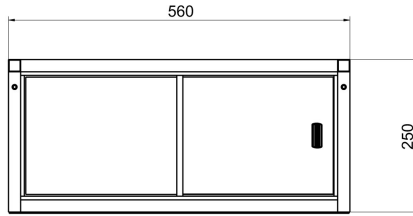
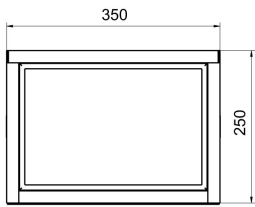

Anti-draft chamber for balances with 128x128 mm weighing pan

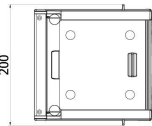

Anti-draft chamber for X2 and R2 precision balances

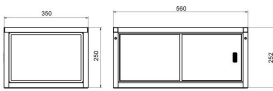
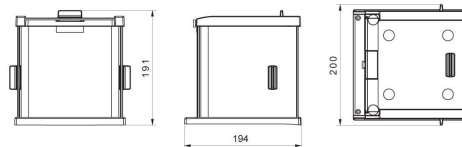

Anti-draft chamber for microbalances

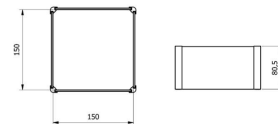

Draft shield for precision balances

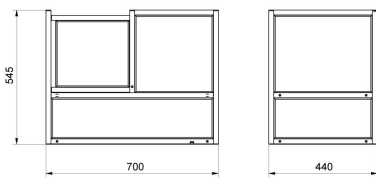

Anti-draft chamber for APP-00-SK mass comparators

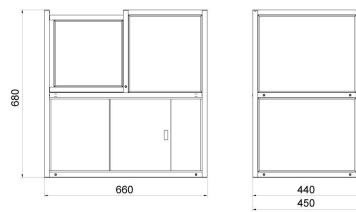

Anti-draft chamber for APP-KO-SK mass comparators



Anti-draft chamber for WAY-KO mass comparators

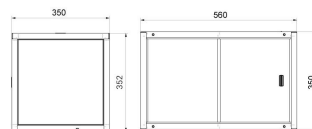

Anti-draft chamber for XA 5Y / XA 5Y.A balances