



More information on the website
mirror.radwag.com/br/info,w1,9VJ

Protetor de ventos para microbalanças

WX-001-0117



The drawings, photos and graphics used are for illustrative purposes only.

Ficha Técnica

Parâmetros físicos	
Dimensão	560x350x252 mm
Dimensões da embalagem L x P x A	695x485x385 mm
Peso líquido	7,6 kg
Peso bruto	10,9 kg

Compatível com (Additional Fee)

Microbalança para calibração de micropipetas XA 5Y.M.A.P
Microbalança para calibração de micropipetas MYA 5Y.P
Microbalança para filtros MYA 5Y.F
Microbalança XA 5Y.M.A

Microbalança MYA 5Y
Microbalança XA 5Y.M
Microbalança para pesagem de stents XA 5Y.M.A.S

Dimensões do dispositivo L x P x A

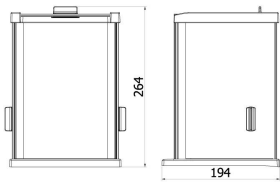
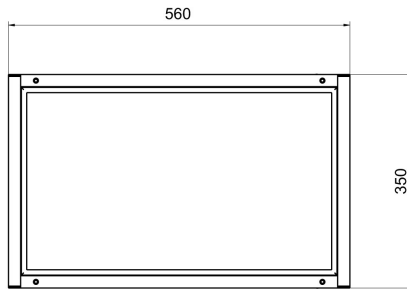
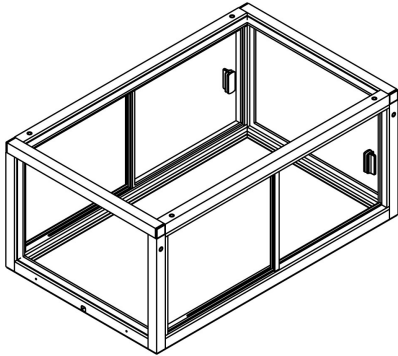
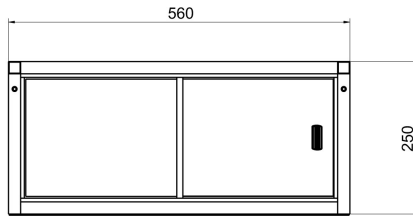
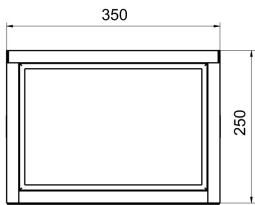

Anti-draft chamber for balances with 128x128 mm weighing pan

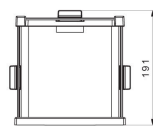
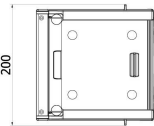

Anti-draft chamber for X2 and R2 precision balances

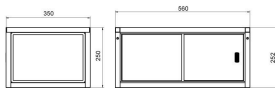
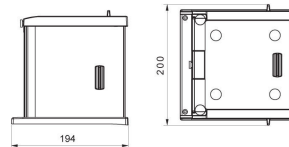

Anti-draft chamber for microbalances

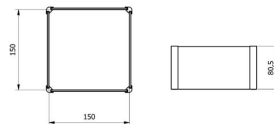

Draft shield for precision balances

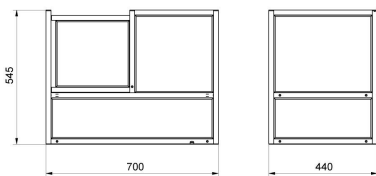

Anti-draft chamber for APP-00-SK mass comparators

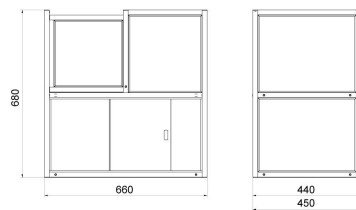

Anti-draft chamber for APP-KO-SK mass comparators

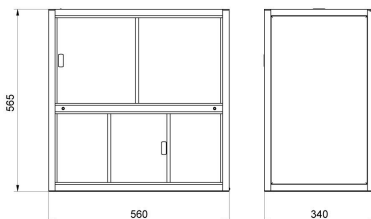

Anti-draft chamber for WAY-KO mass comparators

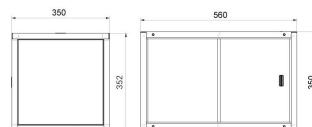

Anti-draft chamber for XA 5Y / XA 5Y.A balances