



More information on the website
mirror.radwag.com/tr/info,w1,9SH

HY10.150.C3.K Çok Fonksiyonlu Terazı

WP-116-0009



The drawings, photos and graphics used are for illustrative purposes only.

Fonksiyonlar

- Dosing
- Labelling
- Plus/Minus Control
- Percent Weighing
- Totalizing
- Parts counting
- Peak hold
- Formulation
- Newton unit measurement
- Statistics
- Checkweighing
- GLP Procedures
- Animal weighing
- Differential weighing
- Replaceable unit
- Statistical Quality Control
- ALIBI Memory
- Transactions

Teknik Veriler

Metrolojik parametreler

Maksimum yük [Max]	150 kg
Minimum yük [Min]	1 kg
Okuma için ruluęu [d]	50 g
Yasallařtırma birimi [e]	50 g

Metrolojik parametreler	
Dara aralığı	-150 kg
Ticari amaçla kullanılmayan terazi için maksimum hassasiyet	5 g
Ayarlama	harici
OIML sınıfı	III
Fiziksel parametreler	
Display	10,1" grafik renkli dokunmatik
Kablo uzunluğu	2,5 m
Tartım kefesi boyutları	500x700 mm
Ambalaj boyutları G x D x Y	800x950x270 mm
Net ağırlık	25 kg
Brüt ağırlık	28 kg
Konstrüksiyon	
IP Sınıfı	IP 65 konstrüksiyon, IP 66 / 67 / 69 terminal
Haberleşme arayüzler	
Haberleşme arayüzü	2xRS232, 2xUSB-A, Ethernet, 4 IN / 4 OUT (dijital)
Opsiyonel arayüzler	modül Wi-Fi 802.11 b/g/n, modül Profibus (DP SLAVE), modül RS485, modül PROFINET (RJ45), analog çıkış modülü (4-20mA, 0-20mA, 0-10V), 12IN / 12OUT (IN – 5-24 VDC, OUT – max 30 VDC, 0,5 ADC)
Elektrik parametreleri	
Güç kaynağı	100 – 240 V AC 50/60 Hz
Çevresel koşullar	
Çalıştırma sıcaklığı	-10 – +40 °C
Atmosferik nem	10% – 85% RH yoğunlaşma yok

* Wi-Fi® is a registered trademark of Wi-Fi® Alliance.



Additional fee for verification



Aksesuarlar (Additional Fee)

AP2-4 Güç döngüsü çıkışı
RS 232 Kablolar (Teraziler - Yazıcı)
Transponder kart okuyucular
RS 232 Kabloları (Teraziler - ZEBRA Yazıcı)
Ağ kabloları (Teraziler - Ethernet)
Display
RS 232, RS 485 Kabloları
Giriş/Çıkış kabloları
Barkod okuyucu

Etiket Yazıcısı
Tartım terminalleri için tutucular
Klavye
Fiş yazıcı
F1 Kütle standardı - ayar odacısız silindirik ağırlıklar, setleri
USB Kablolar (terazi-Epson yazıcı)
Modülleri ek platformları
Ek modüller
RS 232 – USB Dönüştürücü

Yazılım (Additional Fee)

- E2R Tartım [WX-010-0099]
- Audit Trail Reader [WX-010-0186]
- RADWAG Remote Desktop [WX-010-0107]
- Terazi Editörü - EWAG 2.1 [WX-010-0173]

- RAD Key [WX-010-0005]
- Etiket Editörü R02 [WX-010-0094]
- R-Lab [WX-010-0080]
- RADWAG Development Studio [WX-010-0104]

Cihaz boyutları G x D x Y

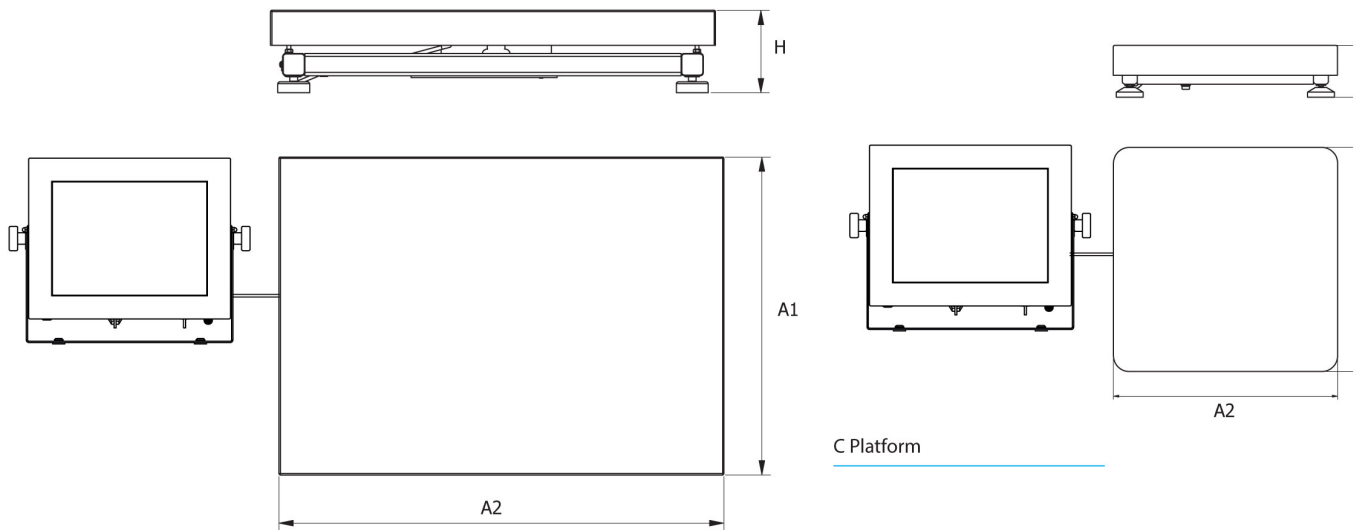

F1 Platform

C Platform

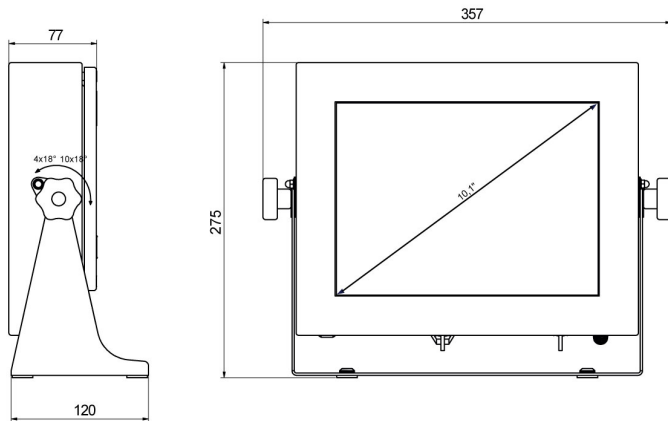

PUE HY10

Scale type	A1	A2	H
HY10.C2.K	400	500	103 ±3
HY10.C3.K	500	700	130 ±3
HY10.F1.K	300	300	70 ±3

dimensions in mm