



More information on the website
mirror.radwag.com/it/info,w1,8Y0

Basamento a cella di carico C315.6/15.F1.M

WP-123-1004





The drawings, photos and graphics used are for illustrative purposes only.

Funzioni

 Plus/Minus Control

 Percent Weighing

 Totalizing

 Parts counting

 Internal battery

 Peak hold

 Newton unit measurement

 GLP Procedures

 Animal weighing

 ALIBI Memory

Specifiche

Parametri metrologici	
Portata massima [Max]	6 / 15 kg
Portata minima [Min]	40 g
Divisione [d]	2 / 5 g
Intervallo di verifica della bilancia [e]	2 / 5 g
Campo di tara	-15 kg
Classe OIML	III

Parametri fisici	
Display	4,3" LCD (backlit)
Dimensione piatto	300×300 mm
Dimensioni del pacco L x P x A	570×390×170 mm
Peso net	5,3 kg
Peso lordo	6,6 kg
Costruzione	
Punteggio IP	IP 65 construction, IP 43 terminal
Costruzione	mild steel St3S
Materiale da pesata	Stainless steel AISI304
Interfaccia di comunicazione	
Interfaccia	RS232
Interfacce opzionali	RS232
Parametri elettrici	
Alimentatore	100 – 240 V AC 50/60 Hz and battery
Massimo assorbimento elettrico	5 W
Tempo operativo delle batterie	max 8h
Environmental conditions	
Ambiente di lavoro	-10 – +40 °C
Temperatura di stoccaggio	-10 – +50 °C
Umidità relativa	10% – 85% RH no condensation
Indicatore	C315



Additional fee for verification



Accessori (Additional Fee)

Tavoli antivibranti
 Alimentatore
 Cavo seriale RS 232 (connessione bilance - Stampanti)
 Cavo di alimentazione con spina per accendisigari
 Display
 Cavo seriale RS 232, RS 485

Convertitore RS 232 – Ethernet
 AP2-1 Modulo di conversione analogica
 Convertitore RS 232 – USB
 Convertitore RS 232 – RS 485
 Stampanti di ricevuata
 Supporto, set di montaggio a muro e braccetti di montaggio

Software (Additional Fee)

• RAD Key [WX-010-0005]
 • Editore per sistemi di pesatura 2.1 [WX-010-0173]

• R-LAB [WX-010-0080]

Device dimensions L x P x A

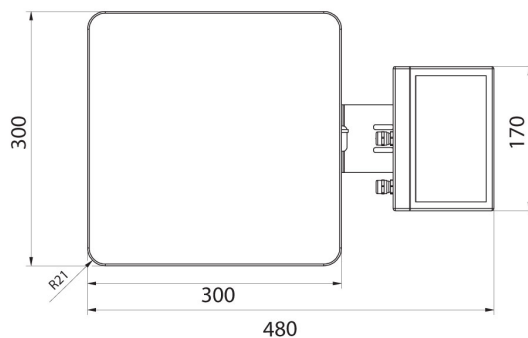
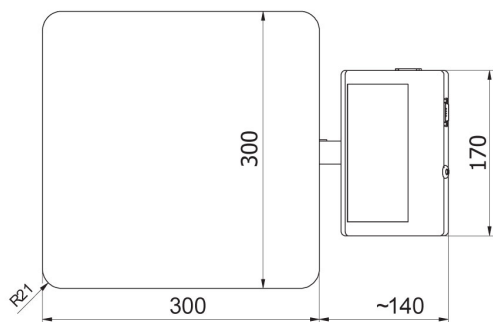
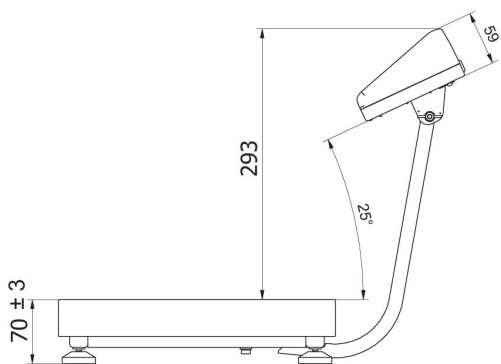

C315.F1.M

C315.F1.R

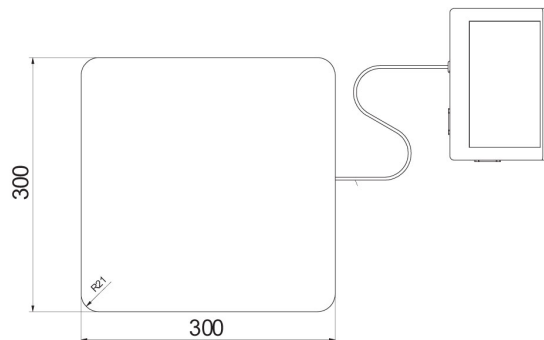
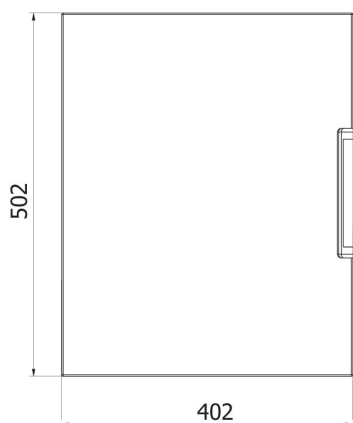
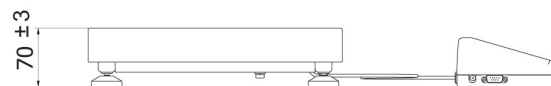
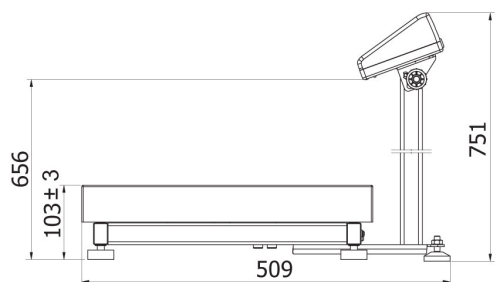

C315.C2.M

C315.C2.K