



Balance multifonctionnelle C32.6.F1.R

WP-120-0010

More information on the website
mirror.radwag.com/fr/info,w1,8XO



The drawings, photos and graphics used are for illustrative purposes only.

Fonctions



Labelling



Plus/Minus Control



Percent Weighing



Totalizing



Parts counting



Newton unit measurement



Statistics



IR sensors



GLP Procedures



Replaceable unit



ALIBI Memory

Paramètres Techniques

Paramètres métrologiques	
Capacité maximale [Max]	6 kg
Capacité minimale [Min]	40 g
Précision de lecture [d]	2 g
Échelon de légalisation [e]	2 g
Étendue de tare	-6 kg
Précision de lecture maximale pour les balances non vérifiées	0,2 g
Classe de précision OIML	III

Paramètres physiques	
Système de nivellement	manuel
Afficheur	5" graphique couleurs
Dimension du plateau	300×300 mm
Dimensions de colis L x P x H	570×390×170 mm
Masse nette	5,3 kg
Masse brute	6,1 kg
Construction	
Degré de protection	IP 65 construction, IP 43 terminal
Construction	acier pulvériséacier St3S
Matériel du plateau	Acier inoxydable AISI304
Interface de Communication	
Interface de Communication	2×RS232, USB-A, USB-B, Ethernet, 4 IN / 4 OUT (numériques), Wi-Fi
Paramètres électriques	
Alimentation	100 – 240 V AC 50/60 Hz
Prise de courant maximale	10 W
Alimentation optionnelle	accumulateur interne
Temps de travail avec l'alimentation d'accumulateur	5 heures
Conditions environnementales	
Température du travail	-10 – +40 °C

* Equipement en option avec supplément de prix

* Wi-Fi® is a registered trademark of Wi-Fi® Alliance.



Additional fee for verification



Accessoires (Additional Fee)

Afficheurs
Alimentateurs
Câbles RS 232 (balance – imprimante)
Câbles d'alimentation de cigare-allume
Lecteurs de code-barres
Câbles RS 232, RS 485
Imprimantes d'étiquettes

Tables antivibratoires
Claviers, manipulateurs
Supports, Statifs, bras-supports
Modules complémentaires
Imprimante de tickets de caisse
Sorties de boucle de courant AP2-1

Software (Additional Fee)

- E2R Pesages [WX-010-0099]
- Éditeur D'étiquettes R02 [WX-010-0094]
- R-LAB [WX-010-0080]
- RADWAG Studio du Développement [WX-010-0104]

- RAD Key [WX-010-0005]
- Alibi Reader [WX-010-0114]
- Éditeur de Balances 2.1 [WX-010-0173]

Dimensions d'appareil L x P x H

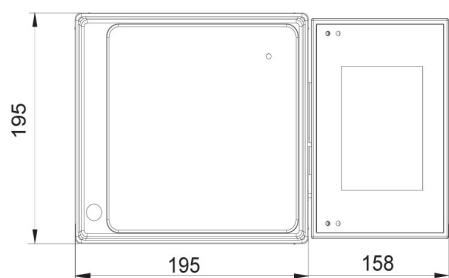
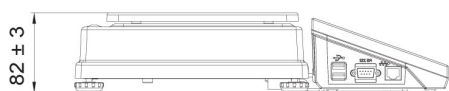

C32.D2

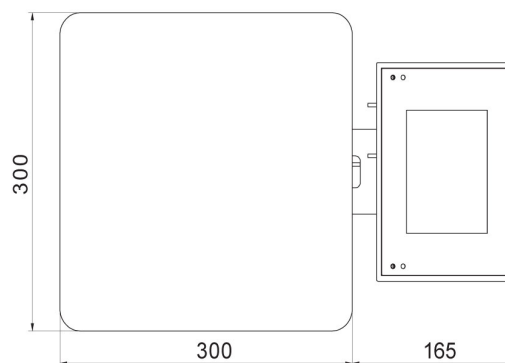
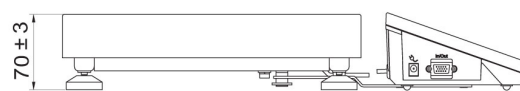

C32.F1.R

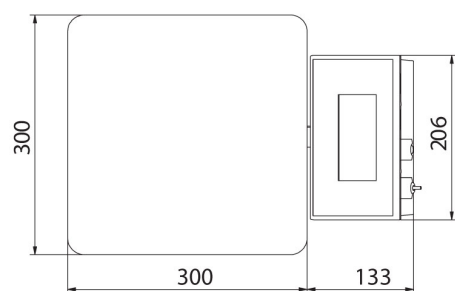
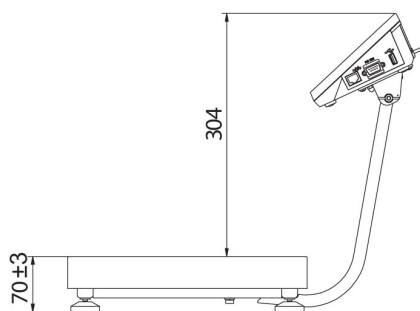

C32.F1.M

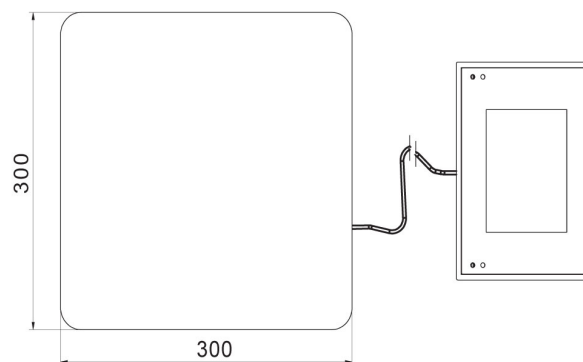
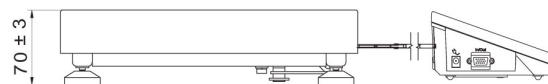

C32.F1.K